

SELECTIVE AUDIO FILTER

By Walter Sikonowiz

If you have reached the limit of your endurance from the interference of background noise and/or competing signals on your receiver, this project was designed for you. This audio filter will increase any receiver's selectivity with no internal modifications.

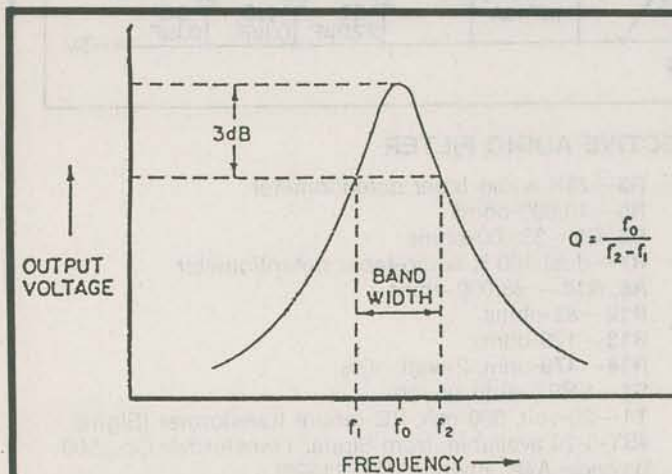

Figure 1. Typical bandpass filter response. Note how the output drops as it moves away from the center frequency (f_0).

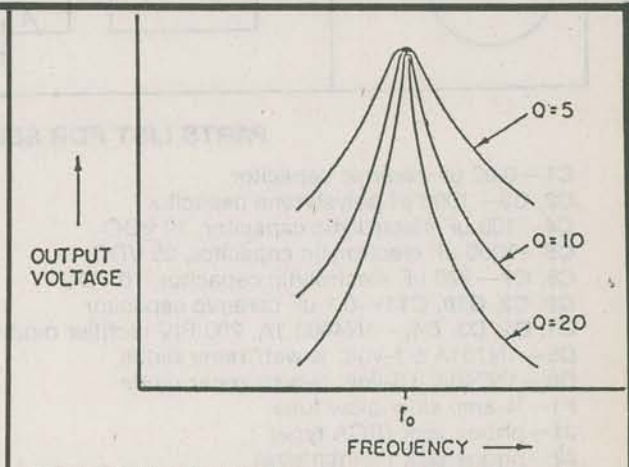

Figure 2. The higher the Q value of the filter, the narrower its bandwidth will be. Obviously, a filter with a Q of 20 will have a narrower bandwidth than one with a Q of 5.

Probably the biggest headache for any ham—novice or oldtimer—is the extreme congestion of today's Amateur bands. Push and shove is the name of the game, with signals crammed sideband-to-sideband in the 3500 kiloHertz allotted to Amateur HF communication. For this reason, a receiver's selectivity—its ability to discriminate between signals close in frequency—is often more important than its sensitivity.

One way to get better selectivity involves the use of a crystal or mechanical IF filter, which is what you'll find in the better ham-band receivers and trans-

ceivers. With bandwidths of 2500 Hz for SSB (single sideband) and 400 Hz for CW (code), these IF filters certainly do improve selectivity. Often, however, the improvement is just not enough. In those tough situations, what you need is a highly selective audio filter like the one presented here.

Not only will this active filter help you to separate closely spaced signals, but it will eliminate most of the annoying background noise as well. It's a real pleasure to copy a clean CW signal without hissing or cracking, especially when headphones are being used. If you're a newcomer getting by with an old,

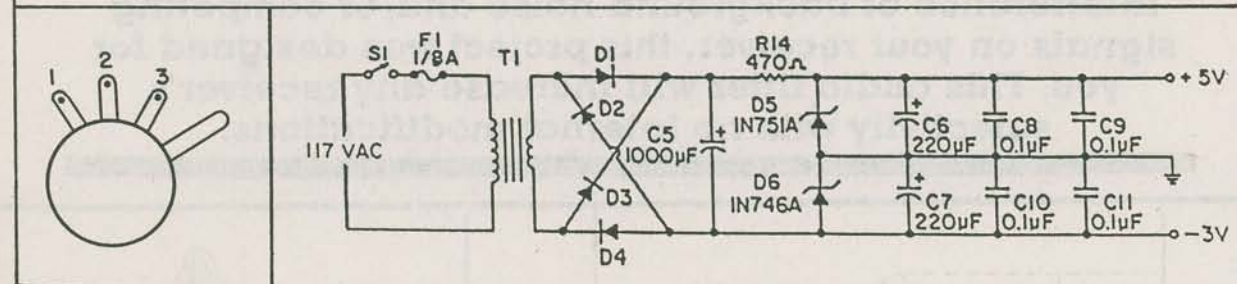
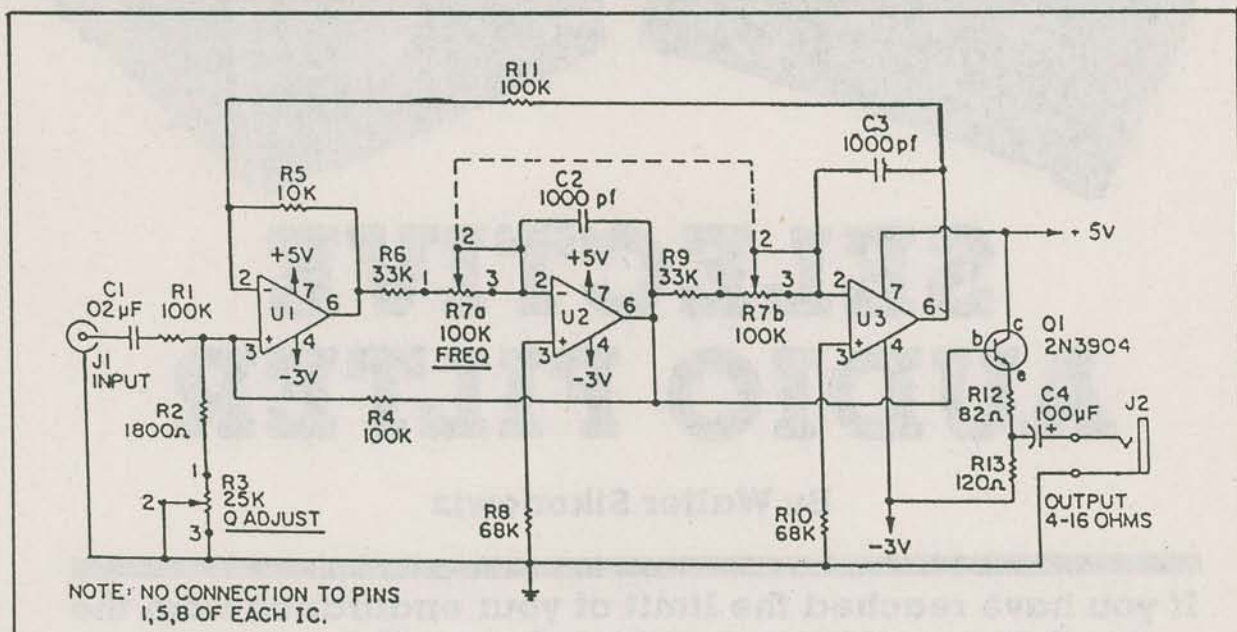

PARTS LIST FOR SELECTIVE AUDIO FILTER

- | | |
|--|---|
| <p>C1—0.02 uF ceramic capacitor
 C2, C3—1000 pf polystyrene capacitor
 C4—100 uF electrolytic capacitor, 10 VDC
 C5—1000 uF electrolytic capacitor, 25 VDC
 C6, C7—220 uF electrolytic capacitor, 10 VDC
 C8, C9, C10, C11—0.1 uF ceramic capacitor
 D1, D2, D3, D4—1N4003 1A, 200 PIV rectifier diode
 D5—1N751A 5.1-volt, 1/2-watt zener diode
 D6—1N746A 3.3-volt, 1/2-watt zener diode
 F1—1/8-amp slow-blow fuse
 J1—phono jack (RCA type)
 J2—phone jack (1/4-inch size)
 Q1—2N3904 NPN transistor
 All resistors 1/2-Watt, 5% Unless Noted Otherwise
 R1, R4, R11—100,000-ohms
 R2—1800-ohms</p> | <p>R3—25K audio-taper potentiometer
 R5—10,000-ohms
 R6, R9—33,000-ohms
 R7—dual 100 K audio-taper potentiometer
 R8, R10—68,000-ohms
 R12—82-ohms
 R13—120-ohms
 R14—470-ohm, 2-watt, 10%
 S1—SPST slide switch
 T1—20-volt, 300 mA, PC-mount transformer (Signal #ST-3-20 available, from Signal Transformer Co., 500 Bayview Ave., Inwood, NY, 11696)
 U1, U2, U3—RCA CA3140 op amp (available from Circuit Specialists, Box 3047, Scottsdale, AZ 85257)
 Misc.—aluminum cabinet, line cord, IC sockets, knobs, etc.</p> |
|--|---|

inexpensive receiver, wait until you try this filter. But even with the fanciest rig around, you'll notice a dramatic improvement in selectivity.

Before examining the details of this circuit, let's talk about the selectivity (sharpness) of a band pass filter. Fig. 1 shows a graph of filter output voltage versus frequency. Here it is assumed that the input signal is a sine wave of varying frequency but constant amplitude. As you can see, the output voltage reaches a maximum at f_0 called the center frequency and drops off as frequency is increased or decreased relative to f_0 . At frequencies f_1 and f_2 , the output has dropped 3 dB (decibels) below its maximum value, that is, to about 70% of the peak voltage at f_0 . The filter is said to have a -3dB bandwidth equal to f_2 minus f_1 , as indicated on the graph. The narrower the bandwidth, the more selective the filter will be in operation.

All About "Q"

Another more convenient measure of selectivity is Q . To specify our bandpass filter's Q , just divide its center frequency by its -3 dB bandwidth. For example, if the center frequency is 1000 Hz and the -3 dB bandwidth is 200 Hz, the filter has a Q of 5. Note that Q is a dimensionless number. Higher Q s will obviously result in more selective filtering, as can be seen from the graph of Fig 2. While high- Q filters are desirable from the standpoint of selectivity, "ringing" will limit the amount of Q that can be used.

Electrical-circuit ringing is similar to the familiar mechanical ringing of a bell: Each time that a bell is struck, its sound lingers for a noticeable period of time after the blow that initiated it. In like manner, a

high- Q filter continues to emit a tone (with frequency equal to f_0) whenever the input signal abruptly drops to zero. Since Morse code is a sequence of sound bursts interspersed with silence, the ringing of a very-high- Q filter will be apparent after every dit and dah. This has the effect of slurring characters together, making them difficult to interpret. Therefore, we need to compromise and use only enough Q to improve selectivity without introducing noticeable ringing.

The bandpass filter presented here can be adjusted to Q values between 1.4 and 15. In addition, its center frequency may be adjusted independently of Q between 375 and 1500 Hz. Using signals from your receiver's headphone jack as input, the filter is capable of driving low-impedance (4- to 16-ohm) headphones directly. The maximum input signal should not exceed 2-volts peak-to-peak, a level sufficient to produce deafening headphone volume.

The Circuit

The type of bandpass circuit shown in the schematic goes by a variety of names: universal, bi-quadratic or state-variable. While there are simpler ways of constructing a bandpass filter, the state-variable approach works better than most. Note that this is an *active* bandpass filter. Instead of a resonant network of inductors and capacitors, this filter is composed of op amps together with resistors and capacitors. No inductors are necessary with this type of circuit.

Signals from the receiver's headphone jack are coupled into the filter through C1 and R1. Potentiometer R3 controls the Q : minimum resistance produces maximum Q , and vice versa. R3 is an audio-

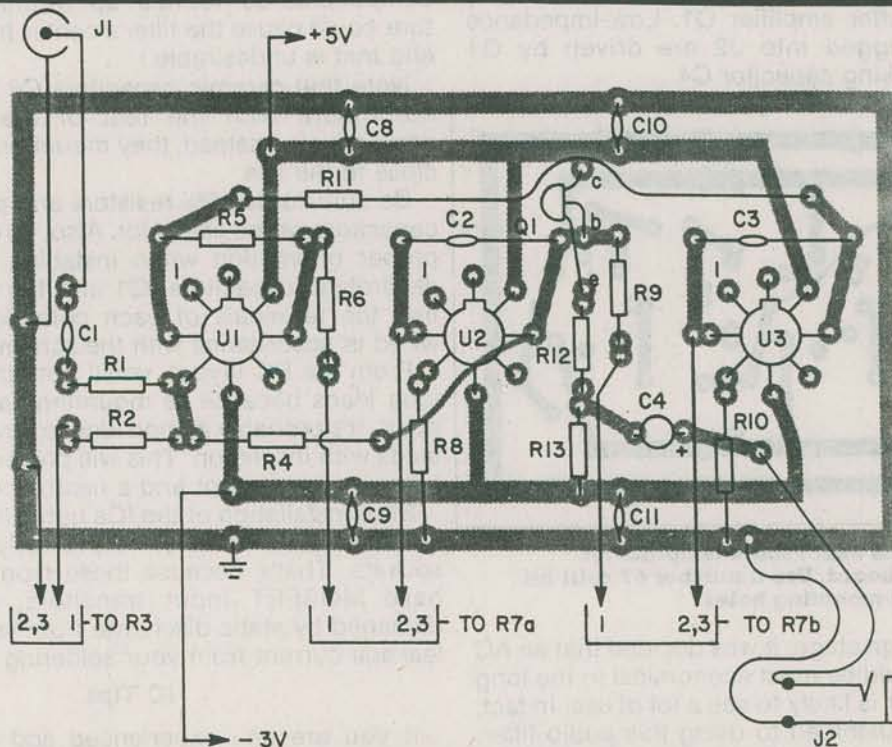

Figure 3. Here is the component layout diagram for the filter PC board. Note the marked, off-board connections for R3, R7a, R7b, J1, J2, and V+. Be certain to wire R7a, R7b, and R3 exactly as shown in the schematic.

taper device whose terminals (1, 2 and 3) must be wired exactly as specified in the schematic. This is necessary to produce a smooth, linear variation in Q as the potentiometer is rotated.

Wired as shown, the potentiometer will produce maximum Q when fully counterclockwise, and minimum Q when clockwise. This is contrary to the norm of having the maximum of any variable in the clockwise position, but you can easily live with it. Actually, a potentiometer with a reverse-logarithmic taper rather than the standard audio taper would produce maximum Q in the clockwise position, but such devices are very hard to find. (Note: If by some unexpected windfall you should locate reverse-log-taper pots, interchange the wiring of terminals 1 and 3 from what is shown in the schematic.)

The three op amps are interconnected by several feedback loops to produce the desired bandpass response. First, there are three simple negative-feedback loops; R5 around U1, C2 around U2, and C3 around U3. Then two more negative-feedback loops connect U2 with U1 (through R4) and U3 with U1 (through R11). Needless to say, the interaction among these op amps is very complex, and we won't dwell any further on it.

The center frequency of this filter can be adjusted by R7, a dual audiotaper potentiometer that, like Q control R3, must be wired exactly as specified in the schematic. Since maximum frequency occurs when both sections of the potentiometer have minimum resistance, fully clockwise rotation will produce a minimum center frequency, and fully CCW rotation will produce the maximum. Again, this is the reverse of the norm, but you'll get used to it.

The bandpass-filtered output, available at pin 6 of U2, is fed to buffer amplifier Q1. Low-impedance headphones plugged into J2 are driven by Q1 through DC-blocking capacitor C4.

capacitor C5 filters the rectified AC to DC. Then zener diodes D5 and D6, together with current-limiting resistor R14, split and regulate the DC, yielding +5V and -3V outputs. Finally, bypass capacitors C6 through C11 help to keep the supply's output impedance low.

Construction

Construction should be easy, but be careful nevertheless. An aluminum cabinet like the 4x4x2 inch LMB minibox used for the prototype is recommended for the sake of shielding. The chassis should be connected to circuit ground, and this is easily accomplished at the input or output jack. Because of the cabinet's small size, the circuit was laid out on two separate PC boards—one for the power supply and one for the filter. This allowed the cabinet's interior space to be used more efficiently. If you do not like working in tight quarters, however, feel free to use a larger cabinet.

Note that a PC-mounting 20-VAC transformer was used for T1. This unit has the advantage of small size, and it may be ordered directly from the manufacturer. The transformer's pins are inserted into the printed circuit and soldered just as a resistor or capacitor's leads would be. Resistor R14 has a 2-watt rating; do not use a half-watt resistor because it will overheat. If you cannot locate a 470-ohm 2-watt unit, three 1500-ohm ½-watt resistors in parallel will yield an equivalent resistance of 500 ohms with a power rating of 1.5 watts. This is an acceptable substitute. Note the ¼-inch-diameter vent holes that were drilled into the back and bottom sides of the prototype's cabinet. These allow for the circulation of air so that the filter's components do not heat up. (A change in temperature could cause the filter's center frequency to drift, and that is undesirable.)

Note that ceramic capacitors C8 through C11 do not mount with the rest of the power supply components. Instead, they mount on the filter board, close to the ICs.

Be sure to use 5% resistors and polystyrene (5%) capacitors where called for. Also, be certain to get the proper orientation when installing the diodes, the electrolytic capacitors, Q1 and the ICs. Remember that the terminals of each potentiometer must be wired in accordance with the schematic.

From the PC layout, you'll note that R11 requires long leads because its mounting pads are quite far apart. It's probably a good idea to cover this resistor's leads with insulation. This will prevent a short circuit between the resistor and a nearby component.

Save installation of the ICs until all other soldering is finished. To be safe, it's probably best to use IC sockets. That's because these type 3140 op amps have MOSFET input transistors, which can be damaged by static discharge from your fingertips or leakage current from your soldering iron.

IC Tips.

If you are an experienced and careful worker, however, it is possible to solder the ICs. First, ground yourself, and insert an IC into its holes on the board. Then, wrap about five turns of very thin, bare wire

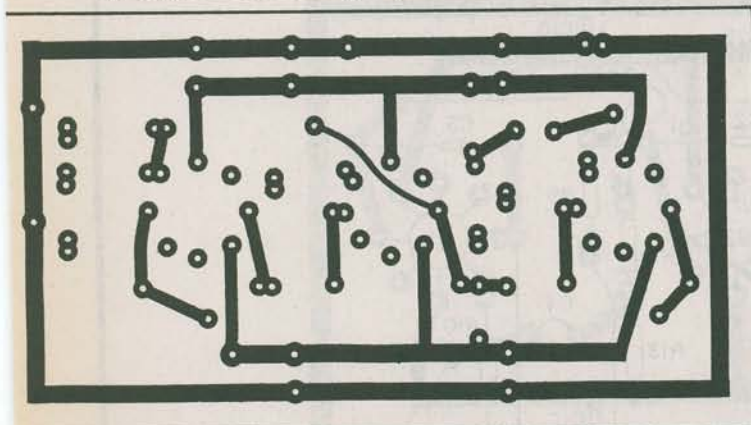

Figure 4. This is the exact-scale template for etching the filter board. Use a number 67 drill bit for all component-mounting holes.

During the design stage, it was decided that an AC power supply would be most economical in the long run, since the filter is likely to see a lot of use. In fact, once you get accustomed to using this audio filter, you'll probably never operate without it. Transformer T1 steps down the 117 VAC line voltage to 20 volts and diodes D1-D4 then rectify the AC. Electrolytic

around the IC's leads so as to short them all together. You can now solder using a low-leakage, grounded iron. Do not unwrap the shorting wires until every last connection has been soldered. But don't forget to unwrap the wires, or your circuit will not work. If all this sounds complicated to you, stick with sockets. As a final note, be sure to use only resin-core solder and a small iron—not a soldering gun—to make all of your soldered connections.

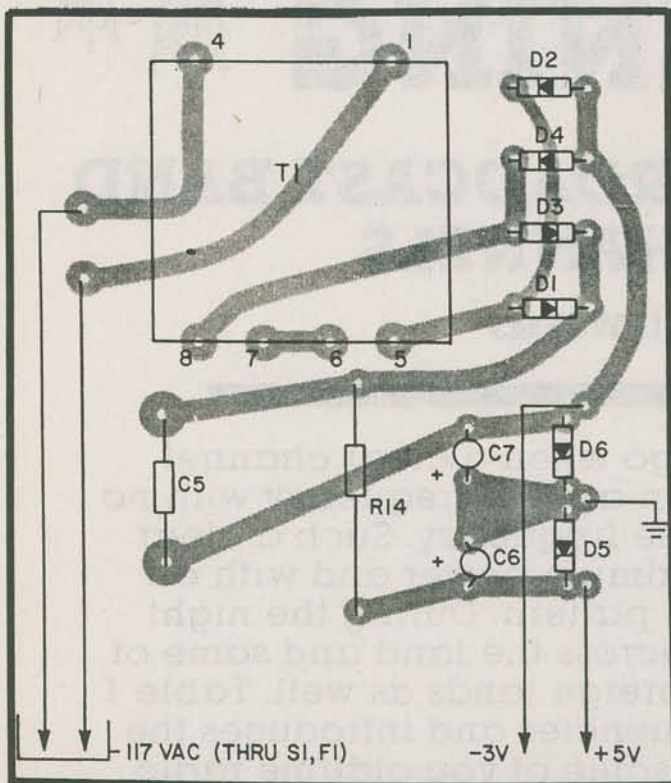

Figure 5. The component layout for the power supply board. Be sure to observe the proper polarity of all diodes and capacitors.

Checkout

That wraps up construction. Double-check your wiring, and then apply power. With a VOM, measure the two supply voltages. If these are in the ballpark, proceed to apply a sine-wave signal of, say 1000 Hz to the filter's input. Make sure that the peak-to-peak amplitude is less than 2 volts.

Plug your headphones into J2. Set R3 for minimum Q, and adjust R7 to maximize the volume of the 1000-Hz tone in your headphones. If necessary, reduce the amplitude of the input to produce comfortable headphone volume. Vary the frequency of your signal generator above and below 1000 Hz, and note the gradual decrease in volume that occurs as the input deviates from 1000 Hz. Return your signal generator to 1000 Hz, then increase your filter's Q with R3. Once again, rock the signal generator's frequency control around 1000 Hz. With high Q you'll notice a much more rapid drop in volume as the input frequency is shifted. (Note: Those who don't own an audio signal generator can skip the above test. However, if the filter fails to improve receiver selectivity, as detailed below, you may need to troubleshoot the circuit. In that case, the above information will be helpful.

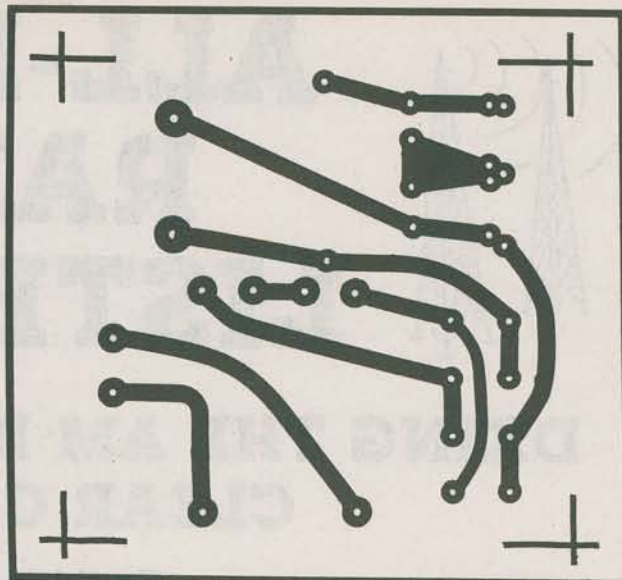

Figure 6. The PC artwork for the power supply board is shown here. As with the filter board, allow room along the edges for drilling holes for the chassis-mounting screws.

Tuneup

If everything checks out OK, the filter is now ready for use with your receiver. To tune things up, you will need a source of unmodulated RF. The best signal is a steady one such as that from an RF generator. Couple it very loosely to the receiver's antenna jack. The marker signal from a crystal calibrator is another excellent choice. If your receiver can tune outside the ham bands, you might even use the unmodulated carrier signal from WWV (at 2.5, 5, 10 or 15 MHz).

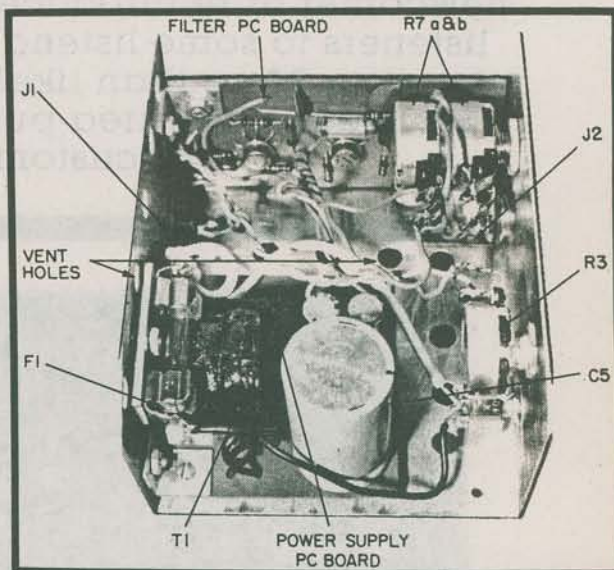

Figure 7. This photograph shows the physical layout of the filter's chassis. It's important that you drill ventilation holes where shown, to avoid frequency drift caused by overheating.

Apply power to both the receiver and the RF signal source. Set the receiver for CW reception, and tune it to the source's frequency (any convenient value). Do

(Continued on page 96)

SELECTIVE AUDIO FILTER

not let the source overload the receiver; weak signals are preferable. Adjust the receiver's fine-tuning to maximize S-meter response.

Now, turn on on your filter. Feed the signal from your receiver's headphone jack to the filter's input (J1), and plug a low-impedance headset into J2. With R3 set for maximum Q, adjust R7 for peak headphone volume.

Disconnect the RF source from your receiver, and set R3 for minimum Q. Now hunt for CW signals on the ham bands. When you encounter a signal plagued by QRM (interference), tune it in as best you can with

receiver's fine-tuning control. Then boost the Q with R3 to cut out the interference.

A Final Note

Although this filter was originally intended for CW operation, it was found to enhance SSB reception, too. As a general rule, less Q should be used for voice reception. Experiment with different values of both Q and center frequency to obtain the best results on SSB. Voices may assume an unnatural quality when sharply filtered, but they *will* be more intelligible. ■
