



iPhone 13 Pro

Repair Manual

Contents

3 [Introduction](#)

Basics

6 [Internal View](#)

7 [Orderable Parts](#)

9 [Screws](#)

10 [Tools](#)

Safety

15 [Battery Safety](#)

18 [Broken Glass](#)

Procedures

20 [First Steps](#)

21 [SIM Tray](#)

22 [Display](#)

50 [Bottom Speaker](#)

55 [Camera](#)

62 [Taptic Engine](#)

66 [Battery](#)

Introduction

This manual includes technical instructions for replacing genuine Apple parts in iPhone and is intended for individual technicians with the knowledge, experience, and tools required to repair electronic devices.

Important

- Read the entire manual first. If you're not comfortable performing the repairs as instructed in this manual, don't proceed.
- Always use the latest version of this document available at support.apple.com/manuals/repair+manual.



Warning

- Failure to follow the repair instructions or to use genuine Apple parts or proper tools may cause fire or other safety issues and lead to personal injury or death.
- iPhone 7 and later are classified as Class 1 Laser products per IEC 60825-1 Ed. 3. These devices comply with 21 CFR 1040.10 and 1040.11, except for conformance with IEC 60825-1 Ed. 3., as described in Laser Notice No. 56, dated May 8, 2019. These devices contain one or more lasers. Use other than as described in the user guide, repair, or disassembly may cause damage, which could result in hazardous exposure to infrared laser emissions that are not visible.



Caution

Failure to follow the repair instructions or to use genuine Apple parts or proper tools may damage the iPhone, parts, or other property, or compromise the device's functionality or water resistance.

Warranty information

Damage caused by repairs performed outside of Apple or the Apple Authorized Service network is not covered by Apple's warranty or AppleCare plans. Such damage may cause future repairs to be subject to out-of-warranty costs or render the device ineligible for future repairs by Apple or Apple Authorized Service Providers.

Tools and parts

Hardware tools

Apple tools are designed to apply the appropriate heat, force, and torque during repairs, and to withstand high-volume professional use.

- The heated display removal fixture softens adhesive to allow separation of the display from the enclosure. The fixture is used with a heated display pocket designed for the device's specific dimensions.
- The display press applies the appropriate amount of pressure to secure new adhesive during display installation. The display press is used with a repair tray and display adhesive press plate designed for the device's specific dimensions.
- The battery press applies the appropriate amount of pressure to secure new adhesive during battery installation. The battery press is used with a repair tray designed for the device's specific dimensions.

Ordering tools and parts

You can learn how to order genuine Apple parts and tools at support.apple.com/self-service-repair. During the purchase process, enter the manual ID **RENLTG** to indicate that you've read this manual in its entirety and agree that you have the knowledge and experience to perform your intended repair.

Software tools

A System Configuration step may be required at the end of your repair. System Configuration is a postrepair software tool that completes the repair for genuine Apple parts. Running System Configuration has a number of purposes that vary based on the part replaced.

What System Configuration does	Why it's important
Transfers factory calibration values	Certain parts like displays, cameras, and ambient light sensors have calibration values that are customized to each individual part during manufacturing. Transferring these values ensures maximum performance and quality after a repair.
Links Secure Element and biometric authentication parts	After repair of a logic board or a biometric authentication part (Touch ID or Face ID), linking the biometric sensors to the Secure Enclave on the logic board is required to ensure device security.
Ensures repair integrity	After a hardware repair, software checks are performed to ensure repair integrity. Repair integrity means that a genuine Apple part has been correctly installed.
Assigns wireless region	To comply with regional communications regulations, a wireless region must be assigned to your logic board.
Updates firmware	Keeping firmware up to date ensures that the device has all the latest security and performance features.

System Configuration requires a strong Wi-Fi network capable of 1.0 Mbps download and upload speeds, with less than 400 ms latency and less than 2% packet loss. Estimated data usage to run System Configuration is 6–22 MB.

The device must be running the latest version of iOS and not a beta version.

Learn how to initiate the System Configuration process at support.apple.com/self-service-repair.

Alerts

Failure to follow alerts could result in fire, injury, data loss, or damage to the device, parts, or other property.



Warning

Instructions for reducing risk of personal injury



Caution

Instructions for reducing risk of data loss or device hardware damage

Important

Supplemental information for successfully completing procedures; neither a Warning nor a Caution

Internal View

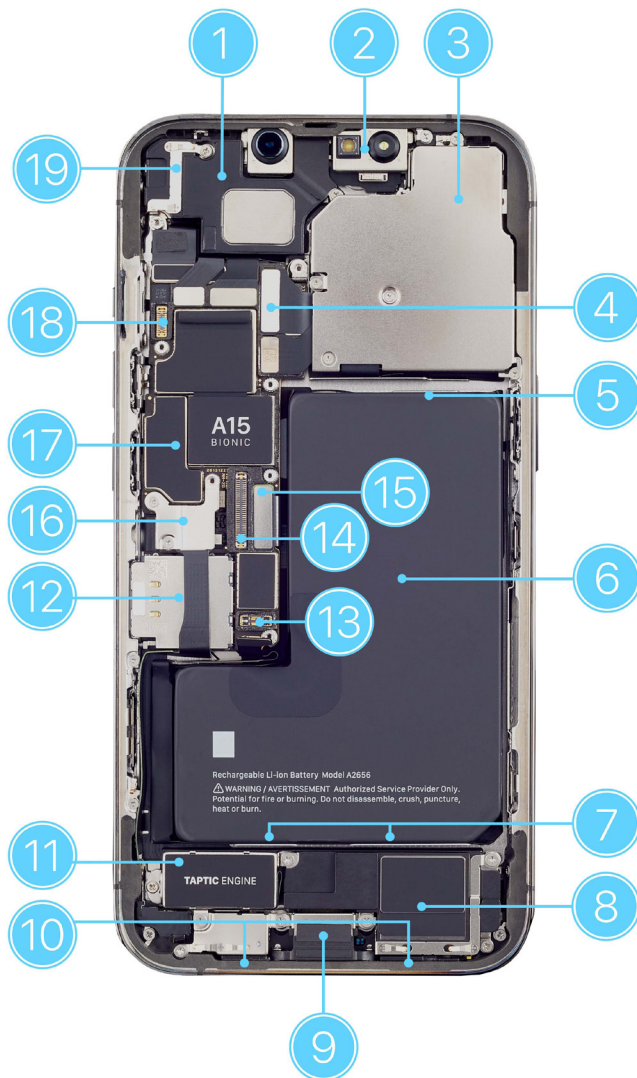

- | | |
|---------------------------------|--|
| 1. Top speaker | 11. Taptic Engine |
| 2. TrueDepth camera assembly | 12. SIM reader |
| 3. Cameras | 13. Battery connector |
| 4. Camera flex cable | 14. Display/Multi-Touch connector |
| 5. Top battery adhesive tab | 15. Dock flex cable |
| 6. Battery | 16. Logic board cowling |
| 7. Bottom battery adhesive tabs | 17. Logic board |
| 8. Bottom speaker | 18. Ambient light/proximity sensor connector |
| 9. Lightning connector | 19. Grounding strap |
| 10. Bottom microphones | |

Orderable Parts

Name	Numbers	Screws
Battery	661-21996	—
Bottom speaker	923-06256	923-06273 (1) lower right 923-06275 (1) upper left 923-06276 (2) lower left, upper right
Camera	661-22293	—
Camera cowling	923-06290	923-06266 (1) middle 923-06267 (1) upper right 923-06268 (3) left, lower left, lower right
Display	661-21993 LL661-21993 (U.S.)	—
Display adhesive	923-06628	—
Lower cowling	923-06289	923-06265 (3)
Rubber gasket	923-06278	—
Security screws		923-06633 (2) graphite 923-06872 (2) silver 923-06873 (2) gold 923-06874 (2) sierra blue 923-07197 (2) alpine green
SIM tray	923-06646 dual, graphite 923-06908 single, graphite 923-06909 single, silver 923-06910 single, gold 923-06911 single, sierra blue 923-06913 dual, silver 923-06914 dual, gold 923-06915 dual, sierra blue 923-07195 dual, alpine green 923-07196 single, alpine green	—

Name	Numbers	Screws
Taptic Engine	923-06258	923-06263 (1) left 923-06280 (1) lower middle 923-06281 (1) right (super screw)
Upper cowling	923-06288	923-06273 (1) upper left 923-06283 (1) upper right 923-06285 (2) lower left, lower right

Screws





Warning

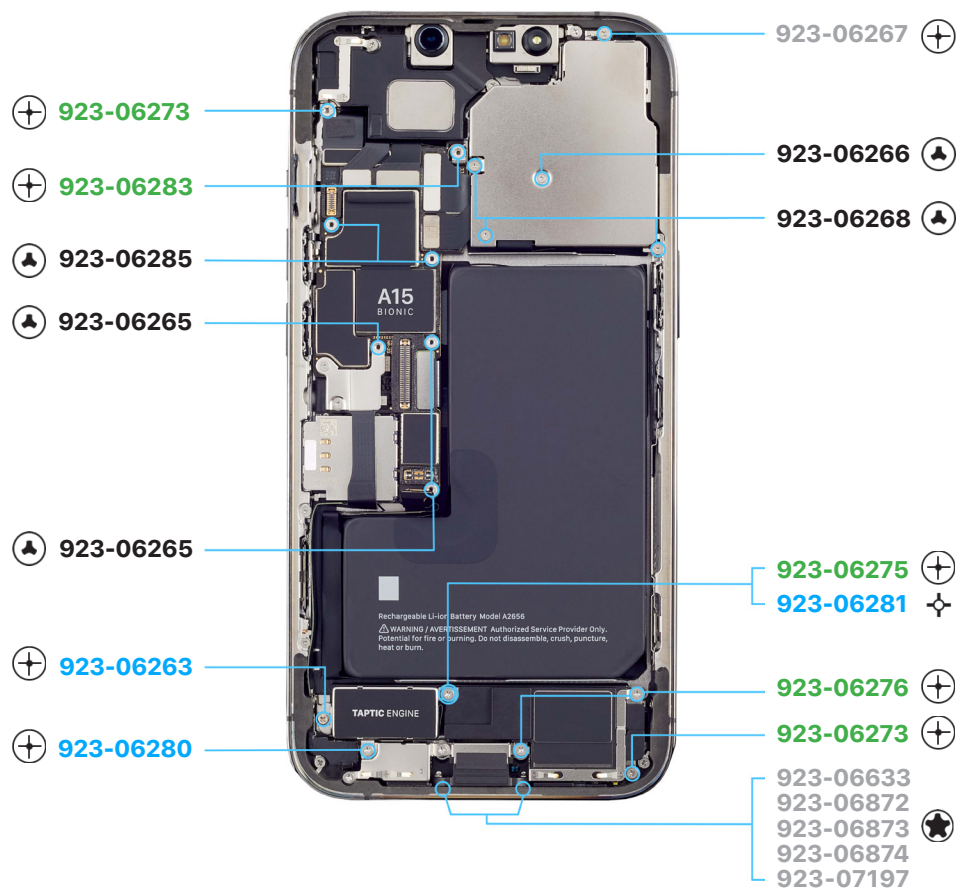

- Never reinstall a screw after it has been removed. Install only new screws. iPhone screw grooves are covered in adhesive that can't be reused.
- Use only the torque driver indicated to install new screws during reassembly. Both overtightened screws and loose screws can damage parts.

Note: You can use any torque driver to remove screws.



- Torque driver (black, 0.35 kgf cm)**
- Torque driver (blue, 0.65 kgf cm)**
- Torque driver (gray, 0.55 kgf cm)**
- Torque driver (green, 0.45 kgf cm)**

-  Crosshead screw
-  Super screw
-  Trilobe screw
-  Security screw

-  Single screw
-  Screw with super screw underneath

*A super screw has a threaded hole that holds another screw.

Tools

Tools with part numbers are available for purchase from the Self Service Repair Store. Tools without part numbers can be purchased from electronics supply retailers.

923-06848

6.1-inch back protective cover

**923-04878**

6.1-inch display protective cover

**661-19620**

6.1-inch heated display pocket

**923-06596**

6.1-inch repair tray

**923-01092**

Adhesive cutter

**923-02657**

Battery press

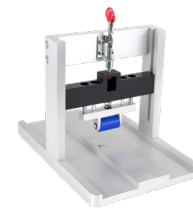

Cut-resistant gloves

**923-06600**

Display adhesive press plate

**661-08916**

Display press



ESD mat



ESD-safe cleaning solution



ESD-safe tweezers



ESD wrist strap with clip or plug



Ethanol wipes¹



[661-17619](#)

Heated display removal fixture

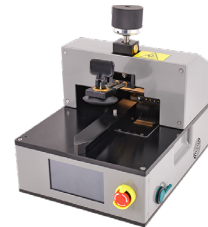

Heat-resistant gloves



IPA wipes



[923-01290](#)

Micro stix® bit



Nitrile or lint-free gloves



[922-5065](#)

Nylon probe (black stick)



Safety glasses with side shields



Sand²Sand container³

923-02066
Super screw bit



923-0248
Torque driver (black,
0.35 kgf cm) kit⁴



923-0448
Torque driver (blue,
0.65 kgf cm)



923-00738
Torque driver (gray,
0.55 kgf cm)



923-00105
Torque driver (green,
0.45 kgf cm)



¹ Ethanol wipes must contain at least 90% ethanol and no additives except isopropyl alcohol.

² Clean, dry, untreated sand (8–10 cups)

³ Sand container (wide-mouthed, quick pour, nonbreakable plastic container with a flip-top lid)

⁴ The black torque driver kit includes a black torque driver (0.35 kgf cm), Torx® security bit (923-0247), and JCIS bit (923-0246).

Heated Display Removal Fixture

Note: A rented heated display removal fixture may have different packaging than shown. If your fixture came with a USB cable, set the cable aside. This setup doesn't require it.

1. Remove the fixture from the box. Then remove the packing Styrofoam.



Caution

Don't lift the fixture by the knob.



2. Cut and remove the zip tie from the handle.

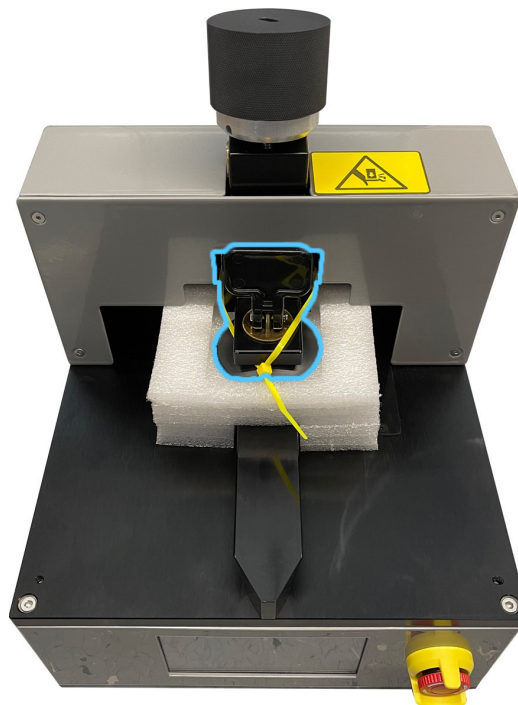

3. Turn the top knob on the fixture counterclockwise to raise the suction cup. Remove the packing Styrofoam.

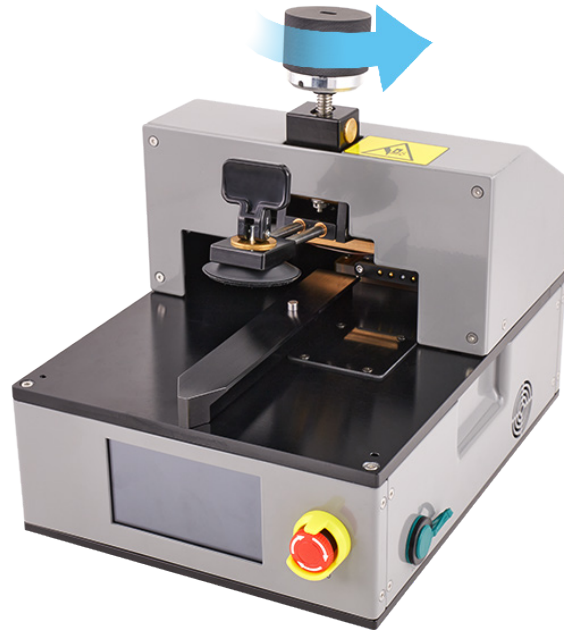

4. Turn the emergency stop knob clockwise until it clicks and protrudes from the stop guard.

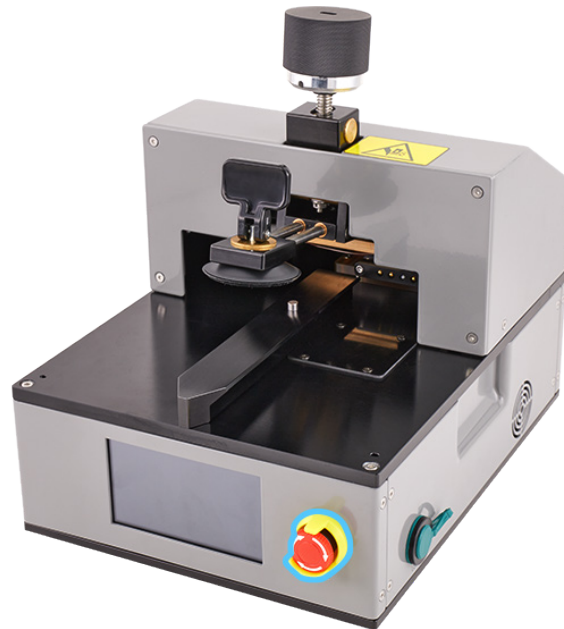

5. Plug the power cord into the fixture. The fixture won't turn on until you flip the switch on the back.

Battery Safety

Warning

- This device contains a built-in lithium-ion rechargeable battery with soft battery cells. Battery safety is the number one concern when repairing a device with a built-in lithium-ion battery.
- Only technicians with the knowledge, experience, and tools required to repair electronic devices should replace a battery.
- Improper battery replacement, improper handling of parts, failure to discharge the battery before repair, or failure to follow the provided instructions could cause battery overheating, swelling, venting, leaking, or a battery thermal event. These events could result in fire, injury, death, data loss, or damage to the device, parts, or other property.
- To avoid these potentially harmful events, follow the battery safety guidelines and work in a safety-focused workspace with the tools listed below. It's important to be prepared for all possible outcomes.

How to set up a workspace for battery safety

Tools

- Clean, dry, untreated sand (8–10 cups)
- Sand container (wide-mouthed, quick pour, nonbreakable plastic container with a flip-top lid)
- Heat-resistant gloves
- Safety glasses with side shields
- ESD-safe cleaning solution

Workspaces used to repair Apple devices should meet the following criteria:

- Nonflammable and electrostatic discharge (ESD)-safe work bench
- At least 2 feet away from paper and other combustible materials
- Sand container within reach (2 feet) on both sides of the workspace, not above the workspace
- Adequate ventilation

 **Warning****How to handle a battery thermal event**

A battery thermal event is a rapid chemical chain reaction that occurs inside a battery cell. The energy stored in the battery is released suddenly, which can cause outgassing and fire. A battery thermal event can be triggered by physical damage to the battery, improper replacement or repair, or temperatures outside the battery's operating range.

Act immediately if you notice any of the following signs of a battery thermal event:

- The lithium-ion battery or a device that contains one begins to smoke or emit sparks or soot.
- The battery pouch suddenly and quickly puffs out.
- The lithium-ion battery or a device that contains one begins to emit hissing or popping sounds.

Don't use water or an ABC or carbon dioxide fire extinguisher on a battery thermal event or a device that is undergoing one. Water and ABC or carbon dioxide fire extinguishers won't stop the reaction.

Do smother the battery or device immediately with plenty of clean, dry sand. Dump the sand all at once. Timing is critical — the faster you pour all the sand, the sooner the reaction will be contained.

Do contact local fire authorities if further assistance is needed.

Do leave the room for 30 minutes after the reaction is contained. Ventilate the area. Don't return until the area is clear of smoke.

Do wait 30 minutes before touching the device. Wear the heat-resistant gloves and safety glasses with side shields to remove the device from the sand.

Do wipe the affected area with water first. Then wipe the area with an ESD-safe cleaning solution.

Do dispose of the damaged battery or device (including any debris removed from the sand) according to local environmental laws and guidelines.

How to handle batteries



Warning

Fully discharge the battery before you begin a repair. A discharged battery is less susceptible to a battery thermal event. If you can't determine the battery level, don't repair the device.

Perform the following steps to discharge the battery:

- Disconnect all external cables.
- Remove all cases and covers.
- Turn on the flashlight from the Lock Screen, in Control Center, or by asking Siri. Wait until the device has turned off and the flashlight is no longer illuminated.



Caution

The flashlight produces heat. Keep the iPhone in a well-ventilated area while the flashlight is illuminated.

Best practices

- To avoid noxious fumes or a battery thermal event, don't puncture, strike, or crush a lithium-ion battery or a device that contains one.
- Keep your workspace clear of foreign objects and sharp materials.
- Be careful when using sharp tools near the battery.
- Don't leave loose screws, extra screws, or small parts inside the device.
- Don't use tools that conduct electricity.
- Don't throw or drop the battery.
- Don't expose the battery to excessive heat or sunlight, or temperatures outside the battery's operating range.
- Handle and dispose of waste batteries in accordance with local laws and regulations.

Broken Glass

Warning

iPhone displays and some back covers are made of glass. The glass could break if the iPhone is dropped on a hard surface, receives a substantial impact, or is crushed, bent, or deformed. Don't attempt to remove chipped or cracked glass shards.

Tools

- Back protective cover
- Cut-resistant gloves
- Display protective cover
- Heated display pocket
- Safety glasses with side shields
- Vacuum cleaner

If the iPhone glass is broken, perform the following steps before you begin a repair:

1. Put on safety glasses with side shields and the cut-resistant gloves.
2. Use a vacuum cleaner to remove glass pieces from your workspace and the iPhone.
3. Attach a protective cover to the broken glass to prevent injury or scattering of glass. Each protective cover has a release liner underneath. Slowly pull the release liner out from under the protective cover while pressing the cover onto the enclosure.
4. Fold the release liner. Use the shiny side of the release liner to firmly press the protective cover onto the broken glass and smooth out any air bubbles.



5. Wait at least 12 minutes for the bond between the protective cover and the glass to strengthen.
6. If the back glass is broken, place the iPhone into the heated display pocket.

If the iPhone has any of the following conditions, stop the repair:

- There's no glass or insufficient glass for the protective cover to adhere to.
- The protective cover doesn't adhere to the iPhone.
- The iPhone doesn't fit in the heated display pocket.

You can find a service option at support.apple.com/repair.

First Steps

Always perform the following steps before starting a repair:

- [Back up the iPhone.](#)
- [Discharge the battery fully.](#)
- [Turn off the iPhone.](#)
- Disconnect all cables.
- Remove all cases and covers.
- Clear and clean your workspace.
- Put on an ESD wrist strap and attach it to a properly grounded ESD mat.



Caution

ESD (electrostatic discharge, or the release of static electricity) can damage electronic components.

Be aware of the following while performing a repair:

- The manual for this model may show images of other models, but the procedures are the same. Ensure that you use the correct tools for the model you're repairing.
- Take your time. Thoroughly read all instructions and alerts.
- Magnetizing the torque drivers will make it easier to work with small screws.
- The end of each flex cable must align with its connector. Press the end of each flex cable to its connector until it clicks to ensure that it's secure.



Warning

Loose screws, extra screws, or small parts inside the device can damage the battery and cause safety issues. Set aside all parts and screws removed during the repair and account for them at the end of the repair.

SIM Tray

Tools

- SIM-eject tool or paper clip

Removal

1. [Find your model to locate the SIM tray.](#)
2. Insert a paper clip or SIM-eject tool into the hole next to the SIM tray.
3. Push the paper clip or SIM-eject tool toward the enclosure to eject the SIM tray.
4. Remove the SIM tray.

Reassembly

1. Press the SIM tray back into the side of the enclosure.

Display

Before You Begin

Warning

- Read [Battery Safety](#) and follow workspace and battery handling guidelines before you begin.
- Read [Broken Glass](#) before you begin.

Tools

- 6.1-inch heated display pocket
- 6.1-inch repair tray
- Adhesive cutter
- Display adhesive press plate
- Display press
- ESD-safe tweezers
- Ethanol wipes or isopropyl alcohol (IPA) wipes
- Heated display removal fixture
- Heat-resistant gloves
- JCIS bit
- Micro stix bit
- Nylon probe (black stick)
- Torque driver (black, 0.35 kgf cm)
- Torque driver (gray, 0.55 kgf cm)
- Torque driver (green, 0.45 kgf cm)
- Torx security bit



 **Caution**

- To avoid damaging the lenses, don't touch the TrueDepth camera assembly or nearby parts.
- Don't touch the back of the display. Touching the back of the display may affect image quality.

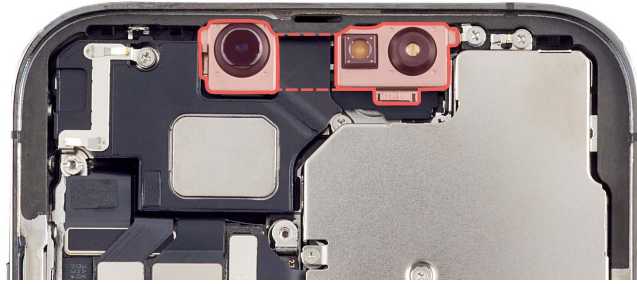
**Important**

- This procedure requires [System Configuration](#). After you've completed all removal and reassembly steps, learn how to initiate the System Configuration process at support.apple.com/self-service-repair.
- Read [Heated Display Removal Fixture](#) if you're setting up the fixture for the first time.

Removal

1. Use a torque driver and the Torx security bit to remove the two security screws, one from each side of the Lightning connector. Set aside the screws.



2. Flip the switch on the back of the heated display removal fixture to turn it on. The internal fan will turn on. Wait for a checkmark to appear on the screen.

Note: If an error code appears on the screen, turn the fixture off and turn it back on.

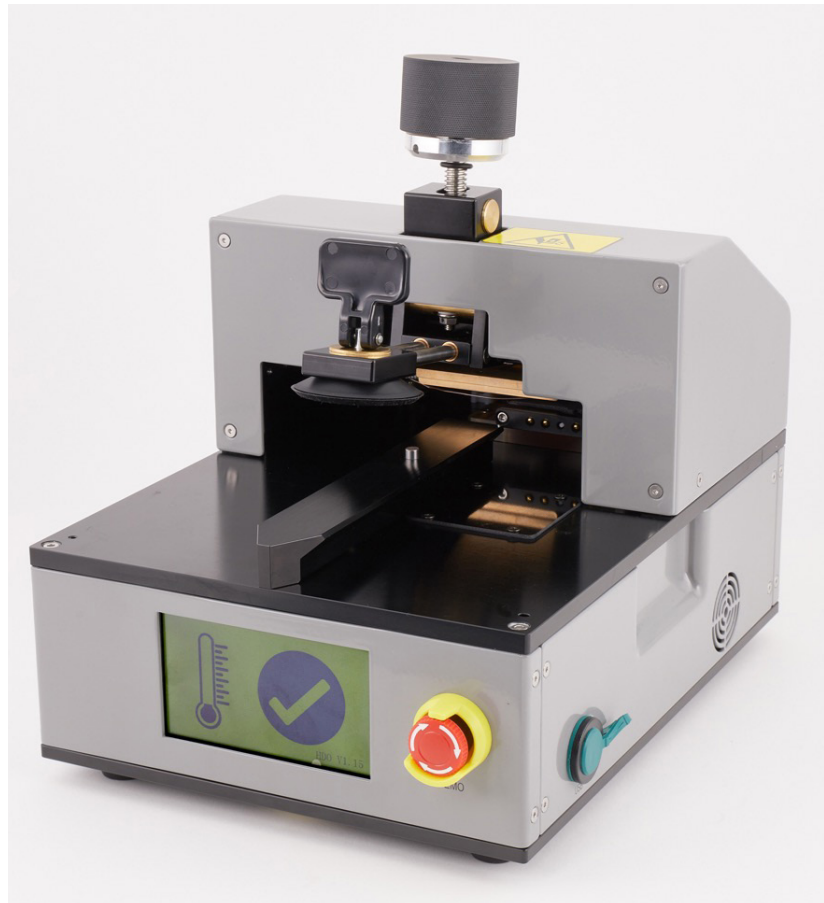

3. Gently insert the iPhone into the heated display pocket with the display faceup and the Lightning connector facing the bottom of the pocket.

Important

Ensure that the clamp on the side of the pocket is flipped up.



4. Flip down the clamp on the side of the pocket to lock the iPhone into place.



5. Put on the heat-resistant gloves. Align the cutout on the bottom of the pocket with the rail on the fixture. Slide the pocket with the iPhone onto the rail on the fixture.

 **Warning**

Don't insert the pocket into the fixture without wearing the heat-resistant gloves.

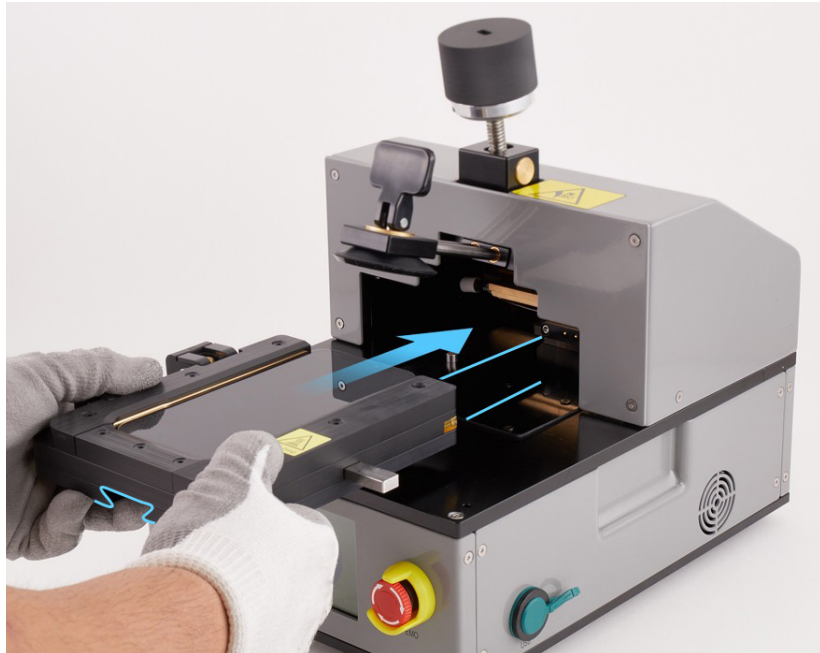

- Slide the pocket into the fixture until you hear the pocket click into place.



Note: The screen on the fixture will turn red and the timer will count down from 2 minutes while the pocket heats to the correct temperature. When the timer ends, the fixture will start to beep and the screen will turn green.



- Turn the knob on the fixture clockwise to lower the suction cup as close to the iPhone as possible without touching the iPhone.

 **Caution**

To avoid damaging the iPhone, don't turn the knob before the timer beeps.

Note: The fixture will beep until the suction cup is lowered.



- Grasp the handle and slide the suction cup straight out until the edge of the suction cup aligns with the bottom edge of the display.

 **Caution**

Failure to align the edges of the suction cup and the display may damage the iPhone.



- Turn the knob on the fixture clockwise to lower the suction cup onto the display (1). Then flip down the handle on the suction cup to secure the suction cup to the display (2).



- Slowly turn the knob on the fixture counterclockwise until the display begins to separate from the enclosure.

Important

If you don't see a gap between the display and the enclosure immediately, wait 30 seconds. If you still don't see a gap, turn the silver part of the knob counterclockwise until the display begins to separate from the enclosure.



11. Insert the edge of the adhesive cutter between the display and the enclosure. Run the cutter between the display and the enclosure to the right and left as shown until the display partially releases from the enclosure.

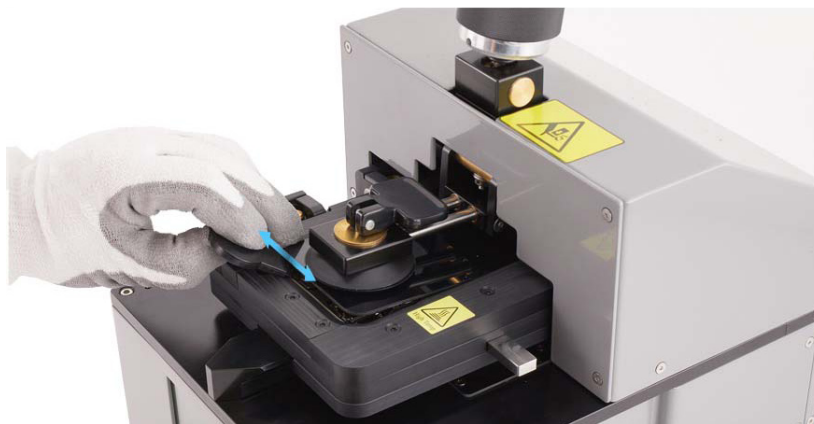

 **Caution**

To avoid damaging the flex cables, don't tilt up the bottom of the display more than 5 degrees.

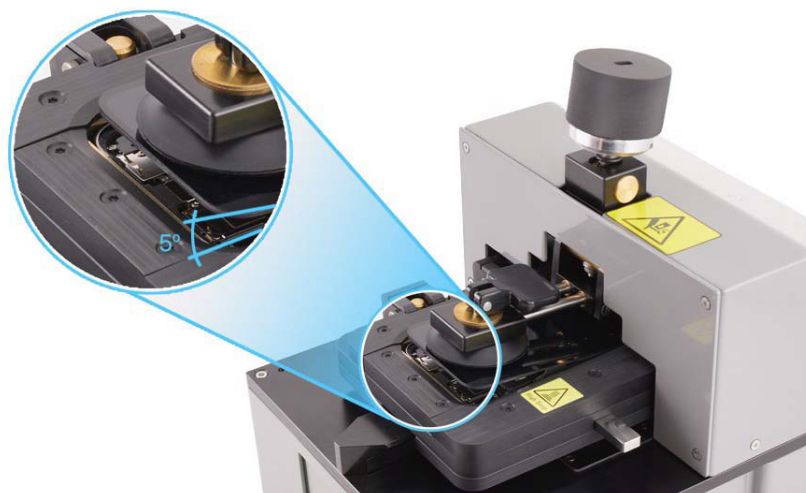

12. Flip up the handle to release the suction cup (1). Gently slide the flat end of the black stick under the edge of the suction cup to release it from the display (2).

 **Caution**

Don't turn the knob.
Turning the knob may
damage the flex cables.

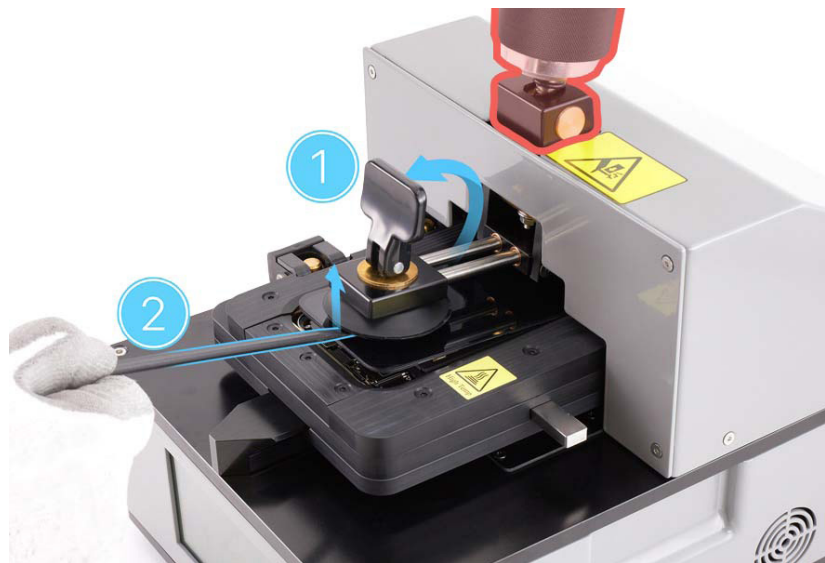

13. Press the eject button on the side of the pocket to release the pocket from the fixture.



14. Hold both sides of the pocket and slide it straight out of the fixture.

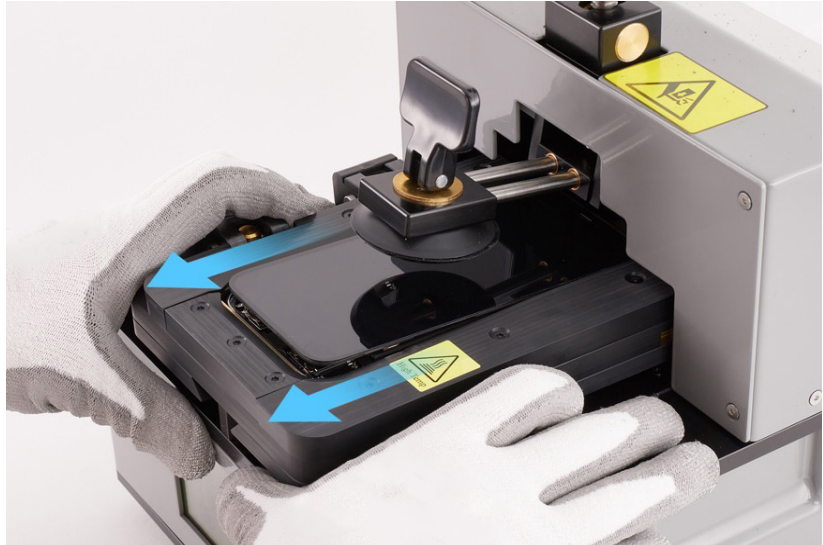

15. Flip up the clamp on the side of the pocket to release the iPhone (1). Hold the area outlined in blue and gently remove the iPhone from the pocket (2).



16. Place the iPhone into the repair tray with the display faceup and the Lightning connector facing the cutout. Remove the gloves.

17. Slide the display slightly toward the bottom of the iPhone.
18. Insert the edge of the adhesive cutter into the top of the iPhone between the display and the enclosure. Hold the adhesive cutter at a 45-degree angle. Start at the middle and cut along the top and sides of the iPhone until the display is free.

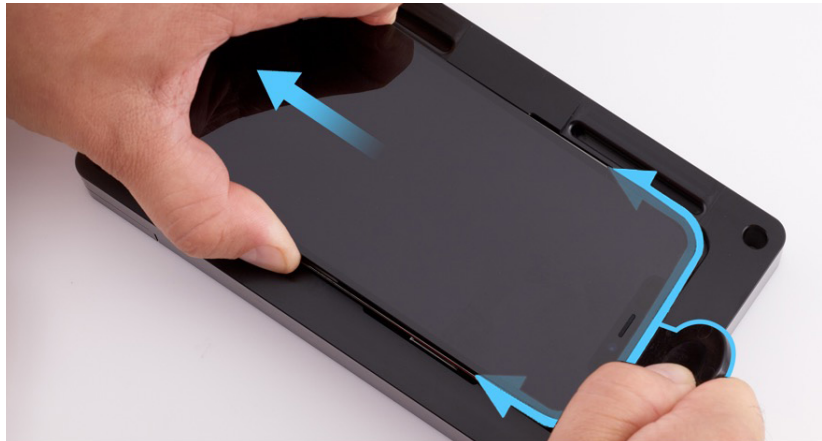

 **Caution**

To avoid damaging the flex cables, don't tilt up the bottom of the display more than 5 degrees.



19. Insert the repair tray suction cups into the slots in the repair tray.



20. Tilt up the display toward the suction cups. Press the top and bottom edges of the display to secure it to the suction cups.

 **Caution**

- To avoid damaging the enclosure or display, ensure that the internal display clips are released before you tilt up the display.
- Don't damage the flex cables as you tilt up the display.

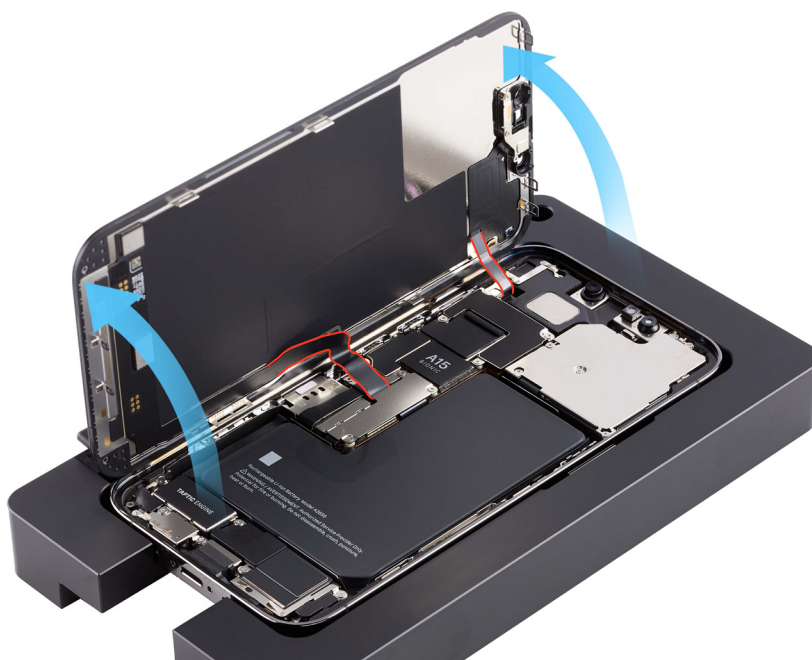

 **Warning**

If the battery is dented, punctured, or otherwise damaged, stop the repair. You can find a service option at support.apple.com/repair.

21. Use a torque driver and the Micro stix bit to remove the three trilobe screws (1) from the lower cowling. Set aside the screws.

22. Use ESD-safe tweezers to remove the lower cowling. Save the cowling for reassembly.

23. Use a torque driver and the Micro stix bit to remove the two trilobe screws (2) from the upper cowling. Set aside the screws.

24. Use a torque driver and the JCIS bit to remove the two crosshead screws (3) from the upper cowling. Hold the cowling in place while you remove the last screw. Set aside the screws.

25. Use ESD-safe tweezers to tilt up the upper cowling. Then slide the cowling out from under the ambient light sensor flex cable. Save the cowling for reassembly.

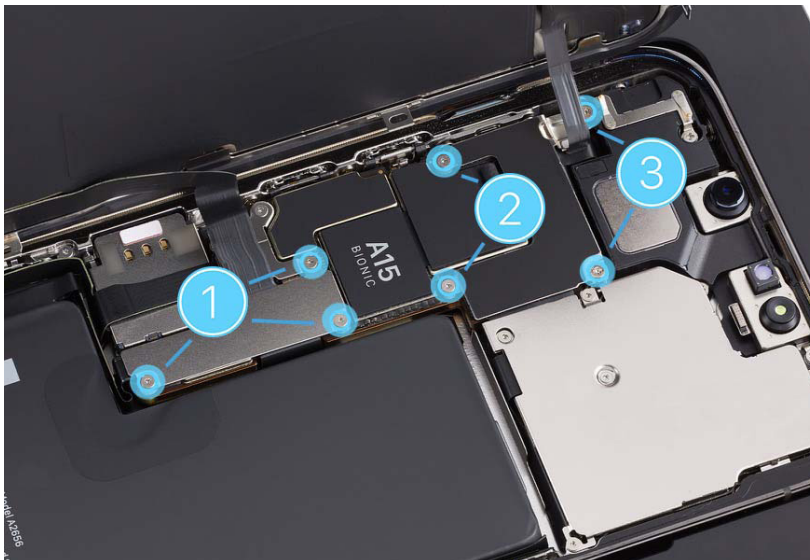

 **Caution**

Don't tear the ambient light sensor flex cable while removing the cowling.

26. Use the black stick to lift the end of the battery flex cable (1) off the connector.

 **Caution**

You must disconnect the battery flex cable first to ensure that the iPhone stays turned off.

27. Use the black stick to lift the ends of the display flex cable (2) and ambient light sensor flex cable (3) off the connectors.

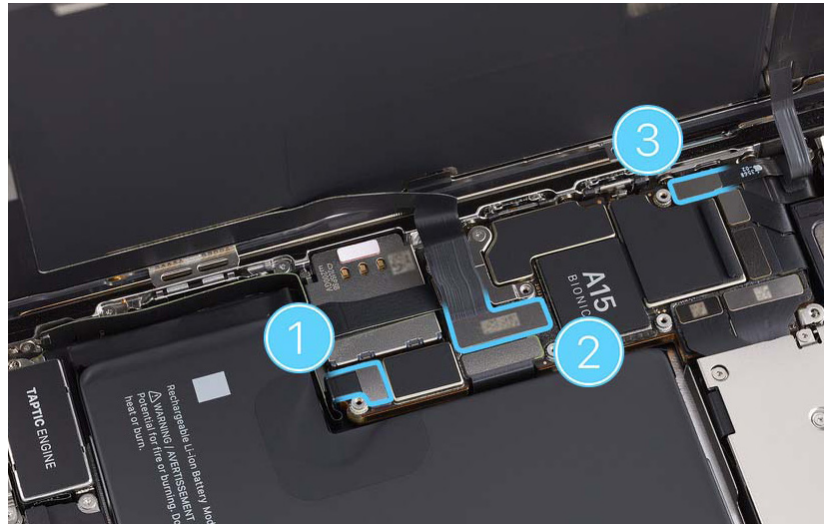

28. Hold the display by the edges. Pull the tabs on the suction cups to release them from the display. Then set the display facedown on a clean, flat surface.
29. Remove the suction cups from the repair tray.

30. Use ESD-safe tweezers to pick up the adhesive. Then use the tweezers or black stick to pull the adhesive from the enclosure. Repeat this process until all the adhesive is removed from the perimeter of the enclosure.



 **Caution**

Don't touch the TrueDepth camera assembly, grounding springs, or nearby parts.



31. Use ESD-safe tweezers to remove the grounding foam from the top of the enclosure above the TrueDepth camera.
32. Use ethanol wipes or IPA wipes to clean any adhesive residue from the enclosure.

 **Caution**

Don't use ethanol wipes or IPA wipes on the display. Ethanol or isopropyl alcohol may damage the display and affect image quality.

Reassembly

1. Inspect the internal display clips for damage before reassembly. Ensure that the internal display clips are at a 90-degree angle and aren't bent or damaged.

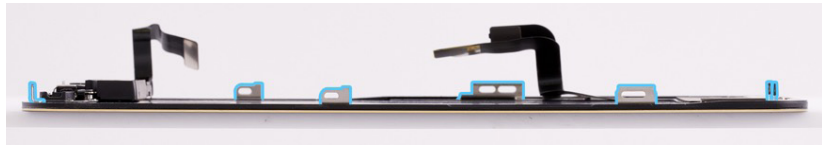

Important

- If the internal display clips are damaged, you may need to replace the display.
- If you're installing a replacement display, peel the protective liner from the top and underside of it.

2. Place the enclosure in the repair tray with the Lightning connector facing the cutout.

3. Inspect the TrueDepth camera. Ensure that the top edge of the TrueDepth camera is under the lip of the enclosure.

 **Caution**

If the TrueDepth camera is positioned incorrectly, use the black stick to move it into the correct position.



 **Warning**

Inspect the enclosure for loose or extra screws and small parts, which can damage the battery and cause safety issues.

4. Align the replacement display adhesive over the enclosure with the grounding foam on top. Ensure that the top holes of the adhesive align over the TrueDepth camera assembly.

 **Caution**

Ensure that you've removed all adhesive residue from the display and the enclosure before you apply the replacement display adhesive.

5. The replacement display adhesive has a top release liner, a middle release liner, and a flexible bottom release liner. Grasp the tab on the bottom release liner. Then slowly pull the bottom release liner (1) out from under the adhesive (2) while pressing the adhesive onto the enclosure.

Important

Don't remove the top release liner yet.

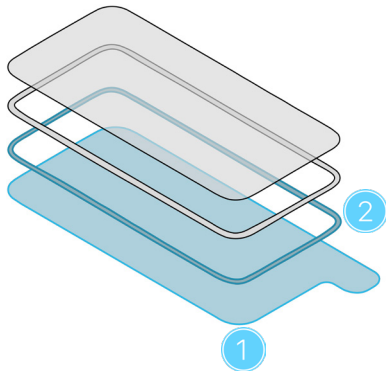

1 Bottom release liner

2 Adhesive

Note: The replacement display adhesive for your model may look different from the illustration, but the steps are the same.



6. Use the black stick to gently adhere the grounding foam as shown.

 **Caution**

Failure to adhere the grounding foam may damage the display, Wi-Fi, or TrueDepth camera.



7. Place the display adhesive press plate on top of the enclosure with the icon in the top right corner as shown.



- Position the repair tray with the iPhone in the display press. Pull down the lever until the display press locks.



- Wait until the timer on the display press beeps. Pull down the lever (1) and pull out the release knob (2). Then lift the lever (3).

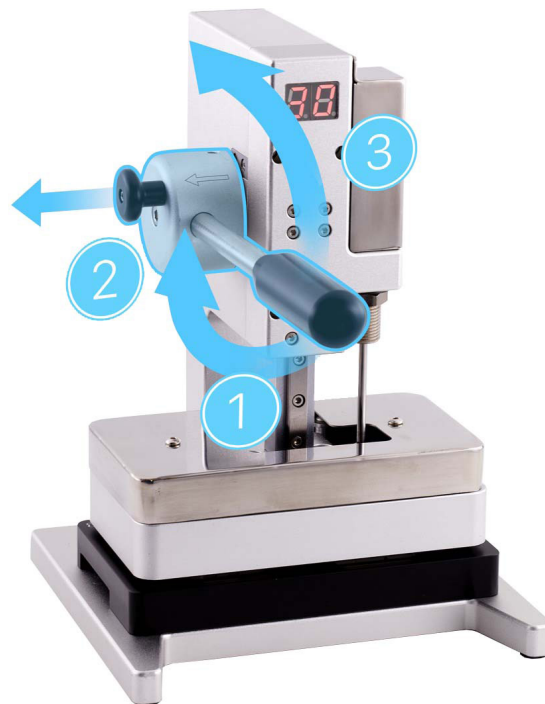

10. Remove the repair tray from the display press and remove the press plate.

11. Remove the left section of the top release liner first (1). Then remove the three sections running along the top (2), right (3), and bottom (4).

Important

Don't remove the middle release liner yet.

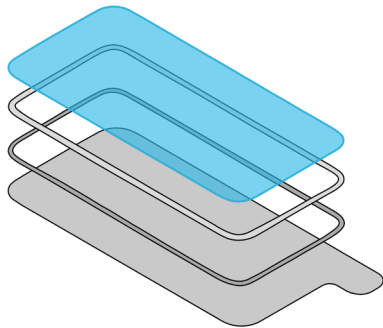

Top release liner

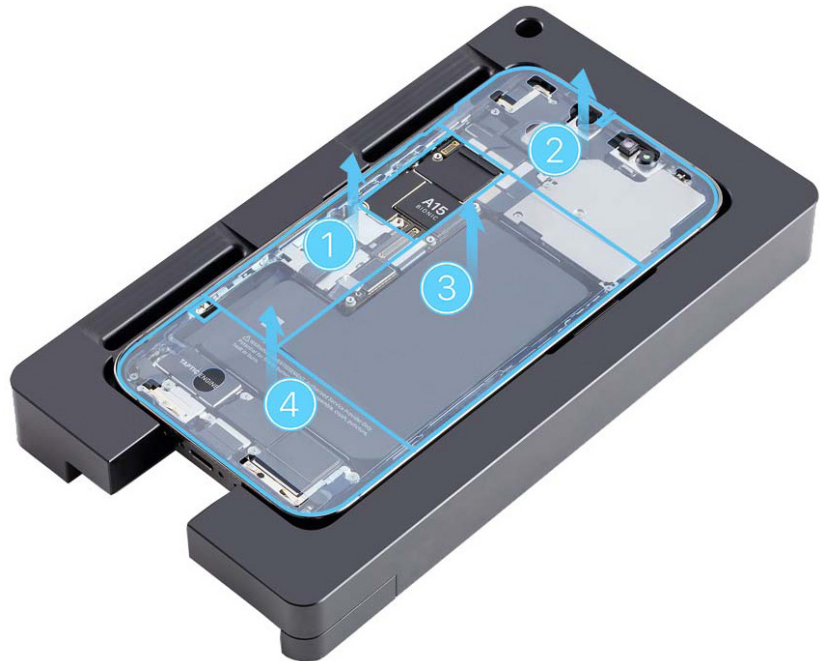

12. Insert the suction cups into the repair tray.

13. Align the left edge of the display with the left edge of the enclosure. Gently press along the edges of the display to secure it to the suction cups.

14. Press the ends of the display flex cable (1) and ambient light sensor flex cable (2) to the connectors. Press evenly along the length of each connector.

15. Press the end of the battery flex cable to the connector (3). Press evenly along the length of the connector.

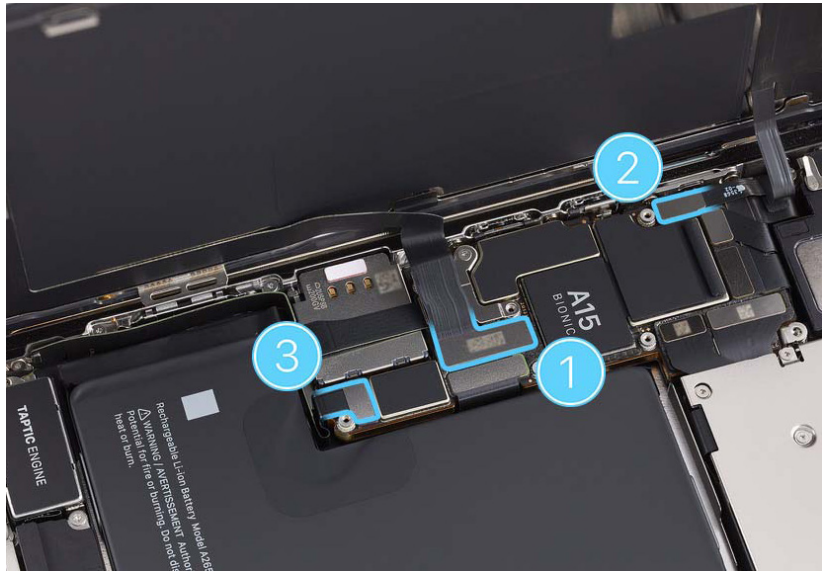

16. Use ESD-safe tweezers to position the lower cowling over the ends of the display and battery flex cables.

17. Use ESD-safe tweezers to slide the tab of the upper cowling behind the ambient light sensor flex cable (1). Then lower the cowling over the end of the flex cable.

18. Use the green torque driver and JCIS bit to install two new crosshead screws into the upper cowling (2).

19. Use the black torque driver and Micro stix bit to install two new trilobe screws into the upper cowling (3) and three new trilobe screws into the lower cowling (4).

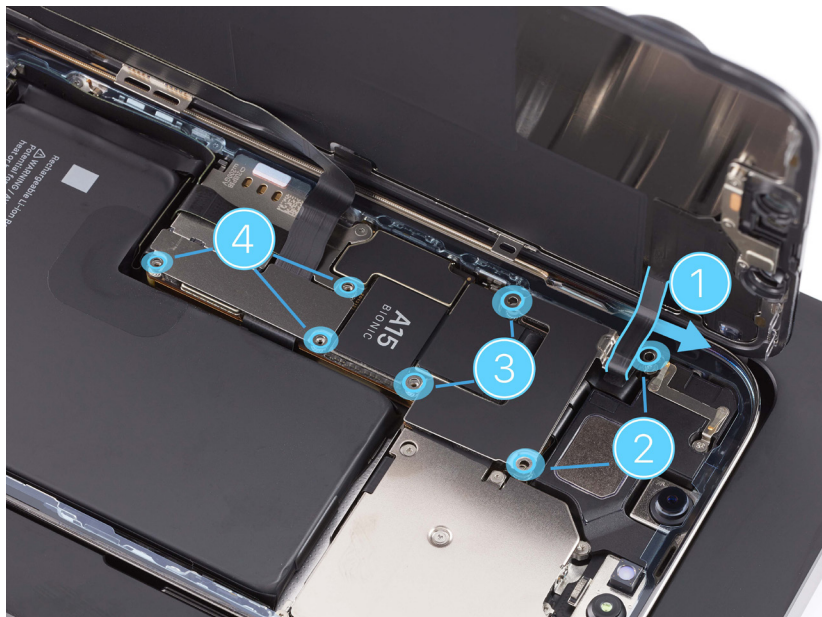

20. Peel the first strip from the middle release liner (1) clockwise, starting near the bottom right of the enclosure. Peel the second strip (2) counterclockwise, starting near the bottom right of the enclosure. Peel the third strip (3) clockwise, starting near the bottom left of the enclosure.

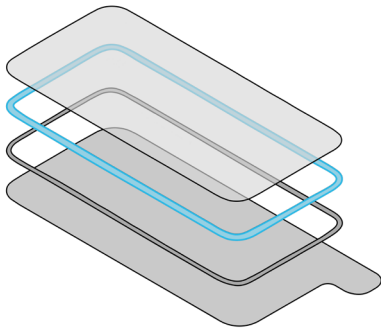

Middle release liner



21. Inspect the display adhesive to ensure that it's in the correct position and not damaged or wrinkled. If the adhesive is damaged, remove it and apply replacement adhesive.
22. Repeat step 3 to ensure that the TrueDepth camera is in the correct position. Then continue to step 23.

 **Warning**

Inspect the enclosure for loose or extra screws and small parts, which can damage the battery and cause safety issues.

23. Pull the tabs on the suction cups to release them from the display. Tilt down the display to rest on the enclosure.
24. Remove the suction cups from the repair tray.

25. Press all four corners of the display simultaneously. Then press along the edges of the display until you hear a click and the display is flush with the enclosure.



 **Caution**

Ensure that the flex cables aren't trapped between the display and the enclosure. Feel the edges of the display for variations or gaps. If the display isn't flush, repeat all removal steps and check the flex cables for damage. Then repeat reassembly steps 1 through 25.

Raised edges



Edges in correct position



26. Position the repair tray with the iPhone in the display press. Pull down the lever until the display press locks.



27. Wait until the timer on the display press beeps. Pull down the lever (1) and pull out the release knob (2). Then lift the lever (3).

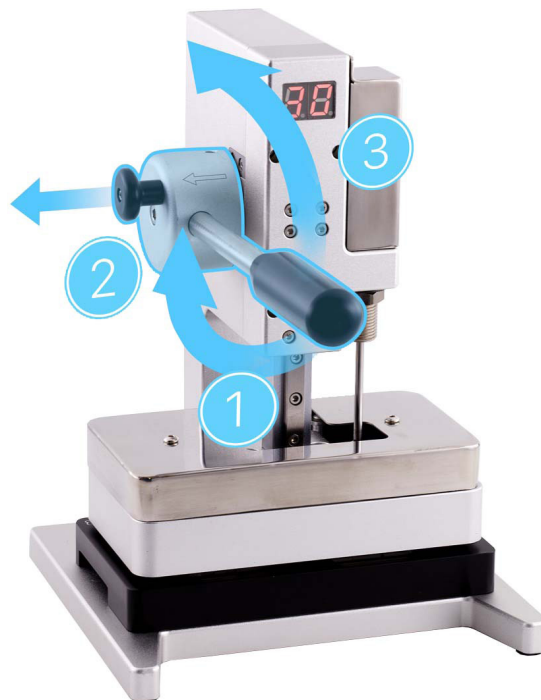

28. Remove the repair tray from the display press.

29. Use the gray torque driver and Torx security bit to install two new security screws, one on each side of the Lightning connector. As you install the screws, press lightly on the display near the Lightning connector.



 **Caution**

If the screws aren't flush, remove and set aside the screws. Repeat step 29 to install another new set of screws. If the new screws still aren't flush, repeat all removal and reassembly steps.

Important

- System Configuration is required if you've installed a replacement display, battery, or camera. Disregard notifications about iPhone features on the Lock Screen until you complete System Configuration.
- After you've completed all removal and reassembly steps, learn how to initiate the System Configuration process at support.apple.com/self-service-repair.

Bottom Speaker

Before You Begin

Warning

Read [Battery Safety](#) and follow workspace and battery handling guidelines before you begin.

Remove the following part before you begin:

- [Display](#)

Tools

- 6.1-inch repair tray
- ESD-safe tweezers
- JCIS bit
- Nylon probe (black stick)
- Torque driver (green, 0.45 kgf cm)



Caution

Avoid touching the grounding springs on the bottom speaker.

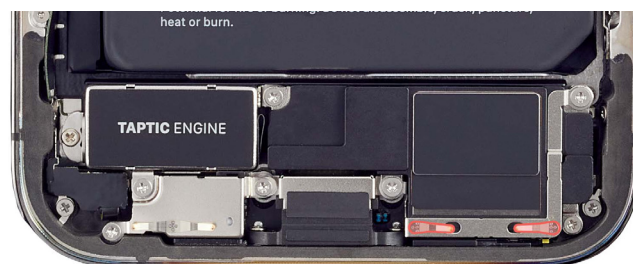

Important

This procedure requires a replacement battery shim, which is available with a replacement bottom speaker, Taptic Engine, or battery. It's not a separate orderable part.

Removal

1. Place the enclosure in the repair tray with the Lightning connector facing the cutout.

2. Run the flat end of the black stick between the battery shim and the Taptic Engine and bottom speaker to loosen the battery shim.



3. Use a torque driver and the JCIS bit to remove the four crosshead screws from the bottom speaker. Set aside the screws.



4. Remove the bottom speaker from the enclosure.

5. Use ESD-safe tweezers to remove the battery shim from the enclosure. Discard the shim.



Reassembly

1. Rotate the repair tray.
Ensure that the rubber gasket is positioned as shown. If the gasket is out of position, use ESD-safe tweezers to reposition it.

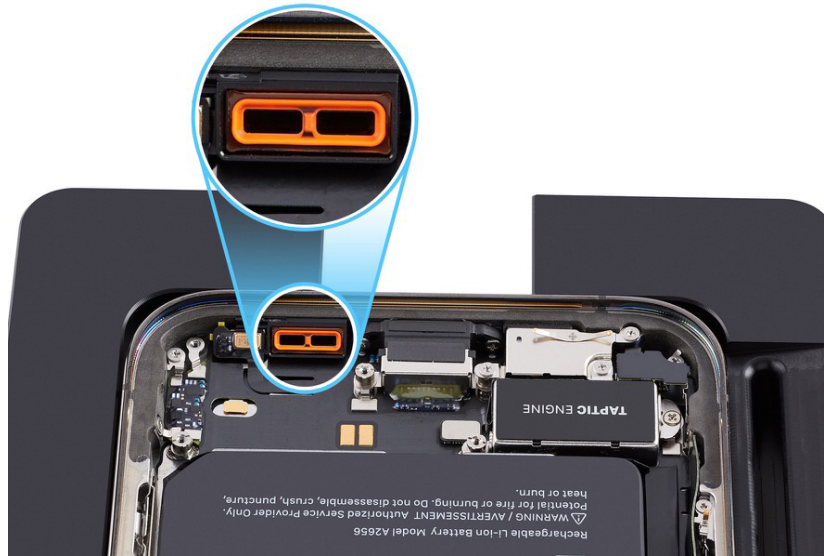

2. Position the bottom speaker in the enclosure.

3. Rotate the repair tray.
Use the green torque driver and JCIS bit to install four new crosshead screws into the bottom speaker. Press the bottom speaker down while you install the screws.

Caution

Don't damage the grounding springs on the bottom speaker.

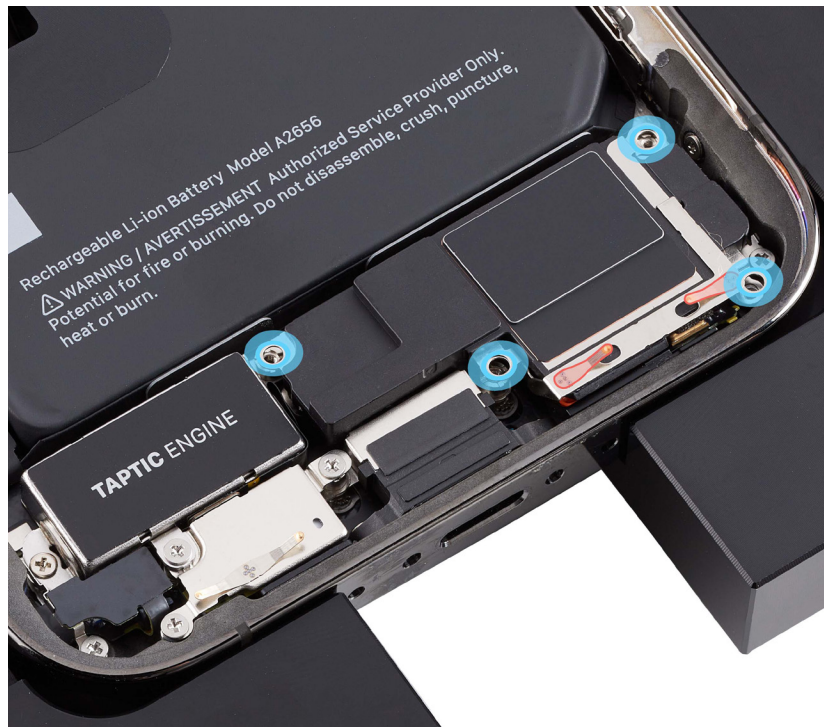

4. Remove the adhesive release liner from the replacement battery shim.
5. Insert the replacement battery shim between the top edges of the bottom speaker and Taptic Engine and the bottom edge of the battery. Ensure that the adhesive side of the shim faces the Taptic Engine and bottom speaker.
6. Run the black stick along the top of the battery shim to adhere it into place.

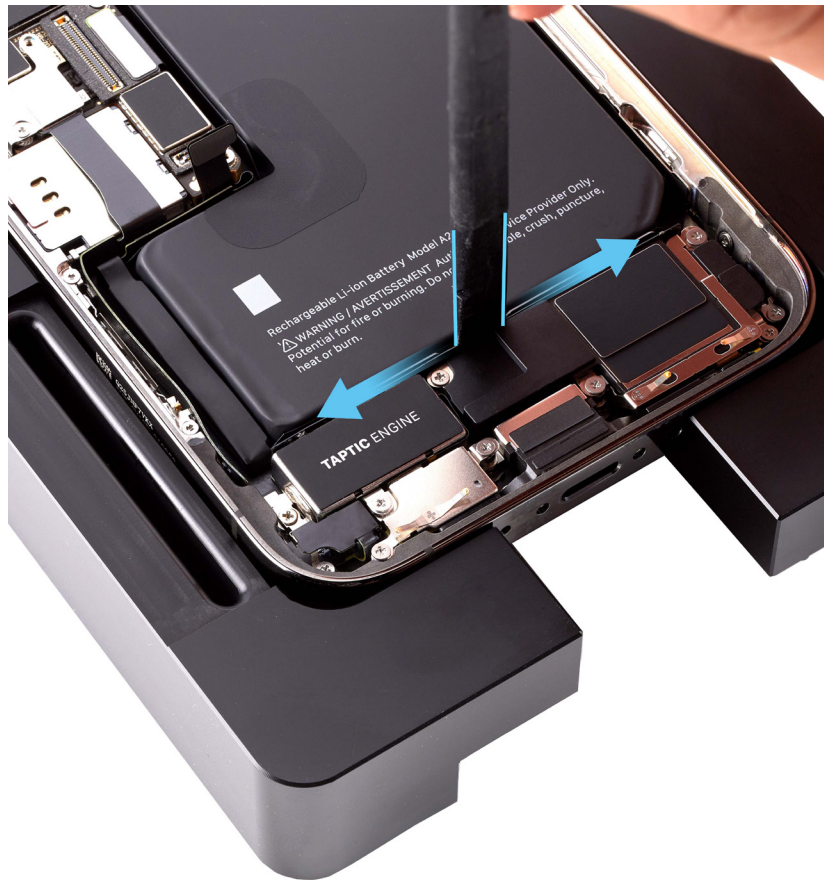

Reinstall the following part to complete reassembly:

- [Display](#)

Camera

Before You Begin

Warning

Read [Battery Safety](#) and follow workspace and battery handling guidelines before you begin.

Remove the following part before you begin:

- [Display](#)

Tools

- 6.1-inch repair tray
- ESD-safe tweezers
- JCIS bit
- Micro stix bit
- Nitrile or lint-free gloves
- Nylon probe (black stick)
- Torque driver (black, 0.35 kgf cm)
- Torque driver (gray, 0.55 kgf cm)



Caution

- To avoid damaging the lenses, don't touch the TrueDepth camera assembly or nearby parts.
- Avoid the grounding spring on the camera cowling.

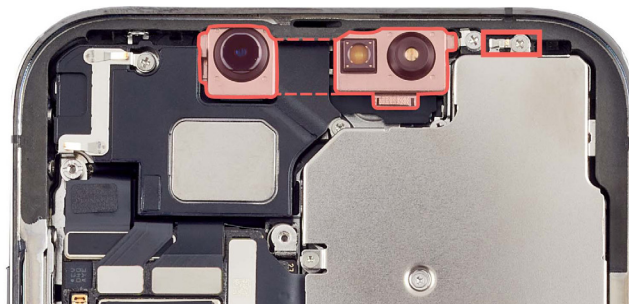

Important

This procedure requires [System Configuration](#). After you've completed all removal and reassembly steps, learn how to initiate the System Configuration process at support.apple.com/self-service-repair.

Removal

1. Place the enclosure in the repair tray with the Lightning connector facing the cutout.

2. Use a torque driver and the Micro stix bit to remove the four trilobe screws from the camera cowling (1). Set aside the screws.

3. Use a torque driver and the JCIS bit to remove the crosshead screw from the camera cowling (2). Set aside the screw.

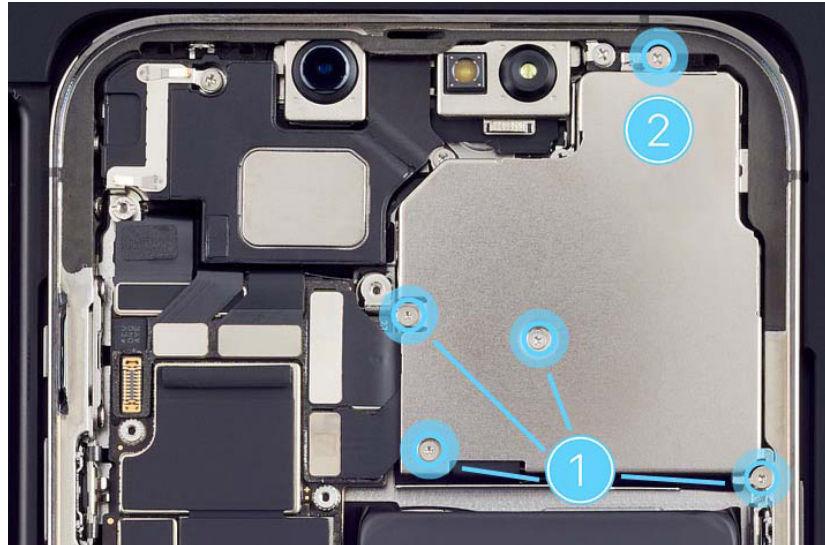

4. Use ESD-safe tweezers to tilt up the left side of the camera cowling (1). Then slide the cowling tabs out of the slots on the right side of the enclosure (2). Save the cowling for reassembly.

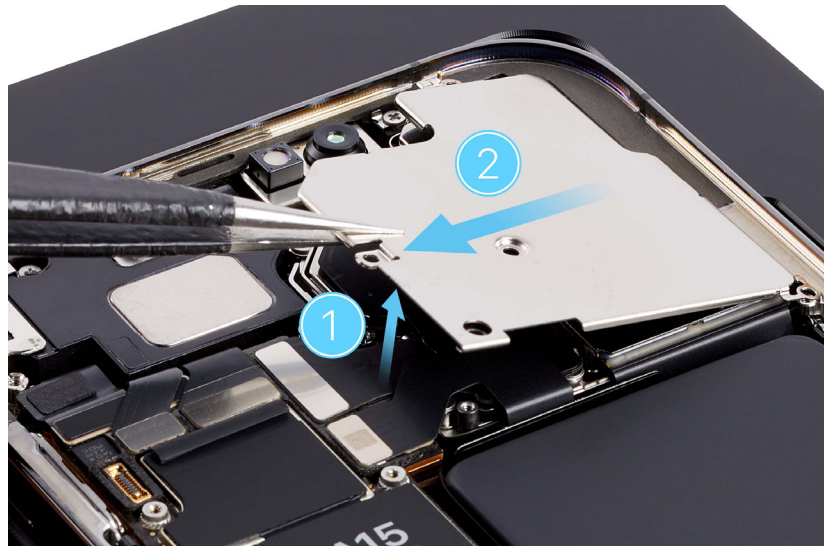

5. Use ESD-safe tweezers to gently lift the ends of the two camera flex cables off the connectors.



6. Gently hold the camera flex cables together and lift the cameras out of the enclosure.



Reassembly

1. Put on the gloves to prevent contamination of the camera lenses. Then hold the replacement cameras with the lenses facedown and remove the protective cover from the camera lenses.
2. Position the cameras in the enclosure. Ensure that the camera flex cables are inside the channel between the battery and the camera well.

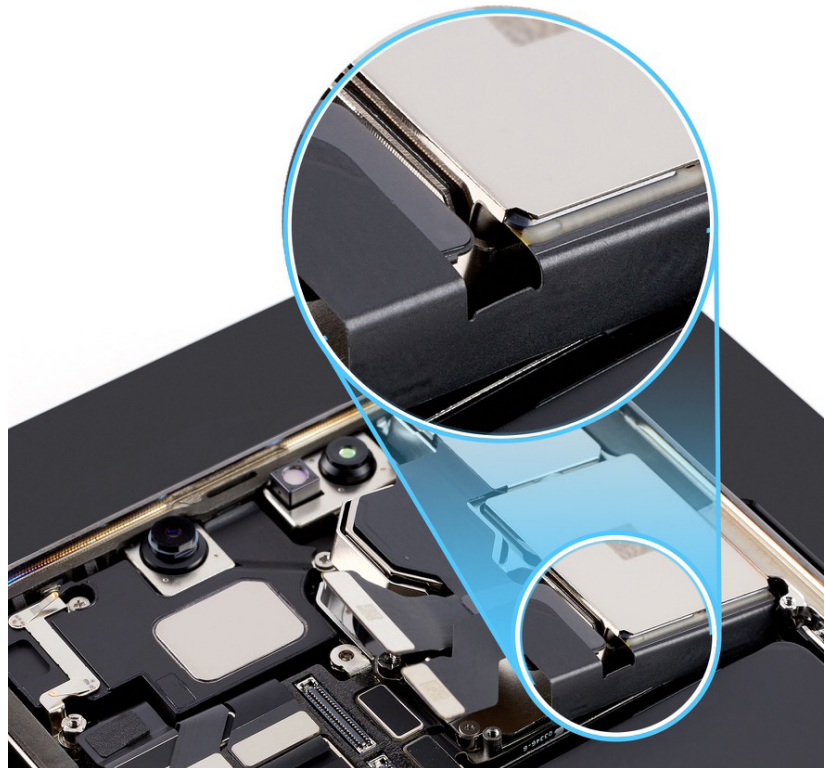

3. Press the ends of the two camera flex cables to the connectors.



4. Lightly press the cameras into the enclosure.

5. The camera cowling has tabs that fit into slots on the right side of the enclosure. Hold the cowling with ESD-safe tweezers and slide the cowling tabs into the slots. Then lower the cowling onto the cameras.

 **Caution**

- Ensure that the screw cutouts in the camera cowling align with the screw holes. A misaligned camera cowling may affect display image quality.
- Ensure that the grounding spring on the camera cowling isn't damaged. Avoid touching the grounding spring as you reinstall the cowling.



6. Hold down the camera cowling. Then use the black torque driver and Micro stix bit to install one new trilobe screw into the middle of the cowling.



7. Use the black torque driver and Micro stix bit to install three new trilobe screws into the camera cowling (1).
8. Use the gray torque driver and JCIS bit to install one new crosshead screw into the camera cowling (2).



Reinstall the following part to complete reassembly:

- [Display](#)

Important

After you've completed all removal and reassembly steps, learn how to initiate the System Configuration process at support.apple.com/self-service-repair.

During System Configuration, you will perform LiDAR Scanner calibration. Prepare for calibration by reviewing the following steps:

1. Use a well-lit area containing objects of different shapes and sizes.
2. Sit or stand 1 to 2 feet from the objects.
3. Hold the device vertically and rest your elbow on your body to help stabilize your arm.

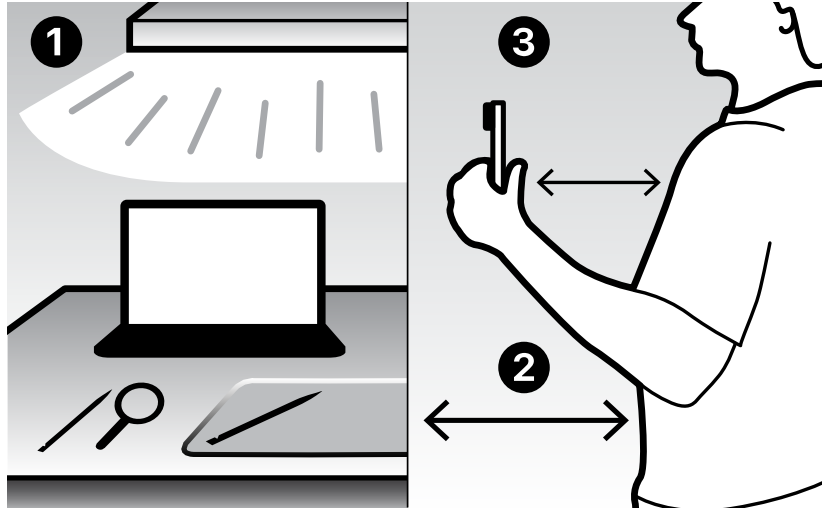

4. Start scanning by slowly panning back and forth to the left and right of the starting point. Follow the directions that appear on the device screen.



Note: The calibration process takes approximately 5 minutes.

Taptic Engine

Before You Begin

Warning

Read [Battery Safety](#) and follow workspace and battery handling guidelines before you begin.

Remove the following parts before you begin:

- [Display](#)
- [Bottom speaker](#)



Tools

- 6.1-inch repair tray
- ESD-safe tweezers
- JCIS bit
- Nylon probe (black stick)
- Super screw bit
- Torque driver (blue, 0.65 kgf cm)

Removal

1. Place the enclosure in the repair tray with the Lightning connector facing the cutout.

2. Use a torque driver and the JCIS bit to remove the two crosshead screws from the Taptic Engine (1). Set aside the screws.

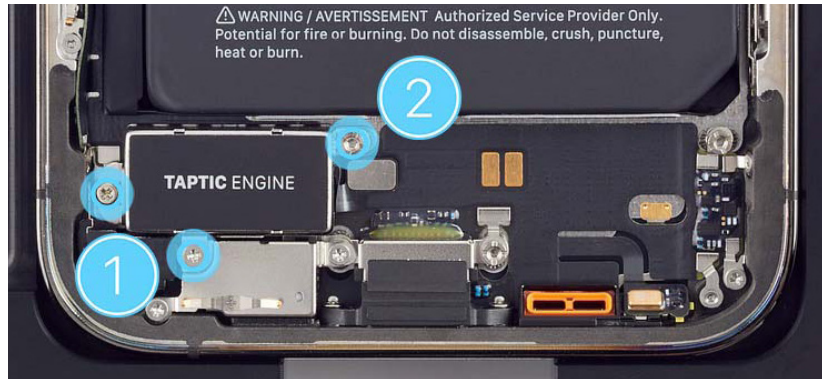

3. Use a torque driver and the super screw bit to remove the super screw from the Taptic Engine (2). Set aside the screw.

4. Lift the end of the Taptic Engine flex cable off the connector.

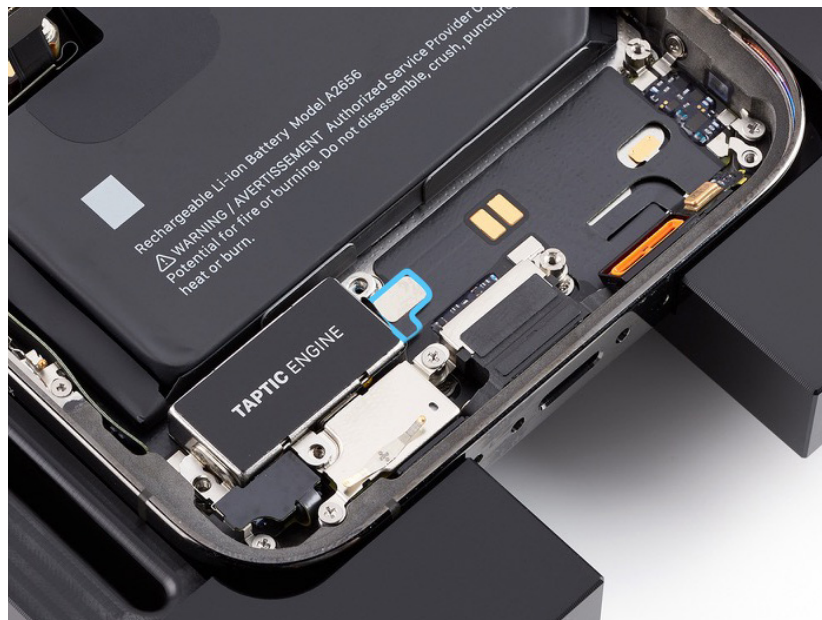

5. Remove the Taptic Engine from the enclosure.

Reassembly

1. Position the Taptic Engine in the enclosure.
2. Press the end of the Taptic Engine flex cable to the connector.

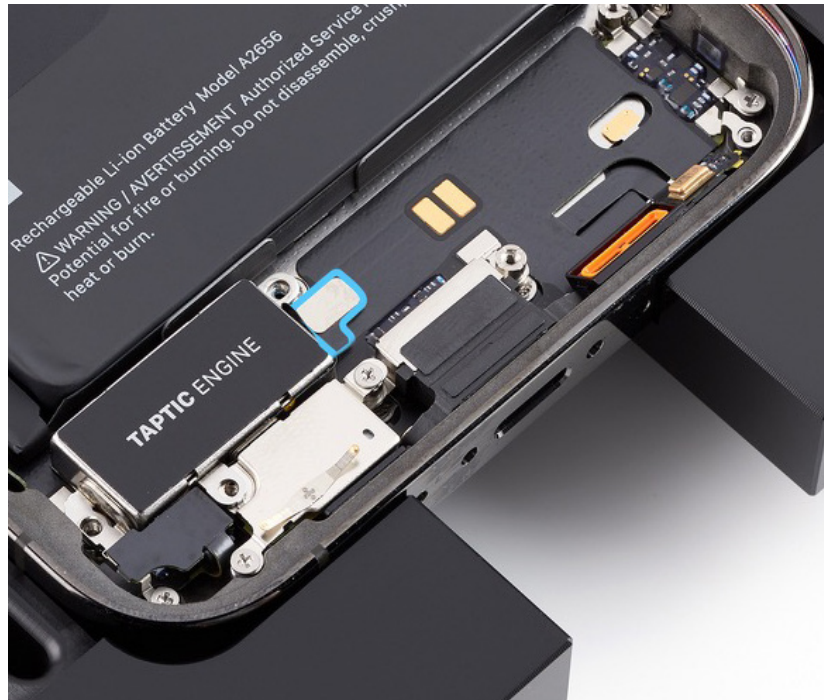

3. Use the blue torque driver and super screw bit to install one new super screw into the Taptic Engine (1).
4. Use the blue torque driver and JCIS bit to install two new crosshead screws into the Taptic Engine (2).



Reinstall the following parts to complete reassembly:

- [Bottom speaker](#)
- [Display](#)

Battery

Before You Begin

Warning

- A battery should be replaced only by individual technicians with the knowledge and experience to repair electronic devices. Improper battery replacement, improper handling of parts, or failure to follow the provided instructions could result in fire, injury, data loss, or damage to the device, parts, or other property.
- Read [Battery Safety](#) and follow workspace and battery handling guidelines before you begin.

Remove the following parts before you begin:

- [Display](#)
- [Bottom speaker](#)
- [Taptic Engine](#)

Tools

- 6.1-inch repair tray
- Battery press
- ESD-safe cleaning solution
- ESD-safe tweezers
- Ethanol wipes or isopropyl alcohol (IPA) wipes
- Heat-resistant gloves
- Nitrile or lint-free gloves
- Nylon probe (black stick)
- Safety glasses with side shields
- Sand
- Sand container



 **Caution**

To avoid damaging the lenses, don't touch the TrueDepth camera assembly or nearby parts.

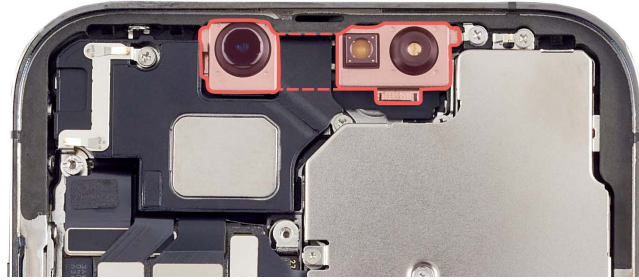
**Important**

This procedure requires [System Configuration](#). After you've completed all removal and reassembly steps, learn how to initiate the System Configuration process at support.apple.com/self-service-repair.

Removal

1. Place the enclosure in the repair tray with the Lightning connector facing the cutout.

2. Use ESD-safe tweezers to grasp the bottom right battery adhesive tab. Gently peel the adhesive tab away from the battery.

Note: The battery has three adhesive tabs.



Warning

Don't scrape or puncture the battery with the tweezers.

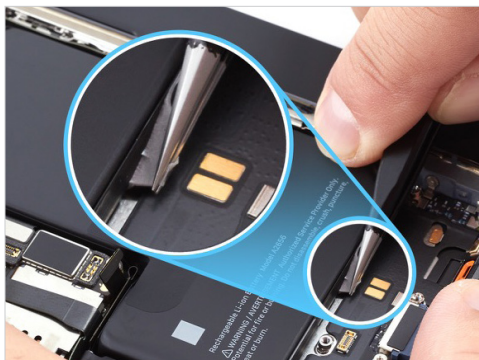

3. Hold down the iPhone. Use ESD-safe tweezers to continue peeling the adhesive tab from the battery.

Important

Peel the adhesive tab completely from the battery before twisting it around the tweezers.



4. Keep the tweezers close and parallel to the battery and twist until you see white adhesive strip on the tweezers.

Important

Don't pull the tweezers until the white adhesive is wrapped around them.

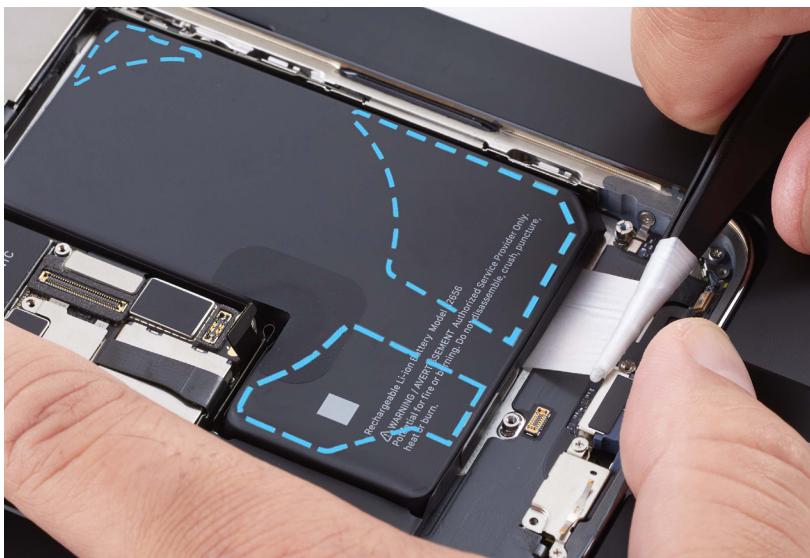

5. Pull the tweezers toward the bottom of the iPhone and continue to twist the adhesive strip until you've removed the entire strip.

 **Caution**

Don't pull the adhesive strip against parts or screws.

Important

If the battery adhesive tab or strip breaks off and you can still see it, attempt to retrieve it with the tweezers. Wrap the tab or strip around the tweezers and repeat steps 4 and 5. If you can't see the tab or strip, continue to step 6.

6. Use ESD-safe tweezers to grasp the bottom left battery adhesive tab. Gently peel the adhesive tab away from the battery.
7. Repeat steps 3 through 5 to remove the bottom left adhesive strip from the battery. If you remove the entire strip, continue to step 8.

Important

If the battery adhesive tab or strip breaks off and you can still see it, attempt to retrieve it with the tweezers. Wrap the tab or strip around the tweezers and repeat steps 4 and 5. If you can't see the tab or strip, continue to step 8.

8. Rotate the repair tray and put on the nitrile or lint-free gloves.
9. Hold down the iPhone. Use ESD-safe tweezers to gently peel the battery adhesive tab from the top of the battery. Then twist the tweezers to wrap the adhesive tab around them.

Important

Hold the tweezers close and parallel to the battery as you twist.

10. Keep the tweezers in the channel between the battery and the camera cowl. Continue to slowly twist the tweezers until you've removed the entire adhesive strip.

Important

If the battery adhesive tab or strip breaks off and you can still see it, attempt to retrieve it with the tweezers. Wrap the tab or strip around the tweezers and repeat step 10. If you can't see the tab or strip, continue to step 11.

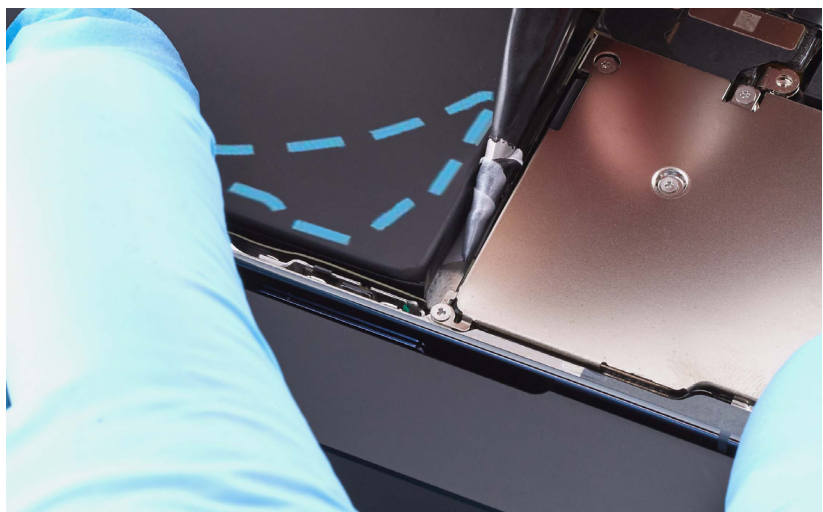
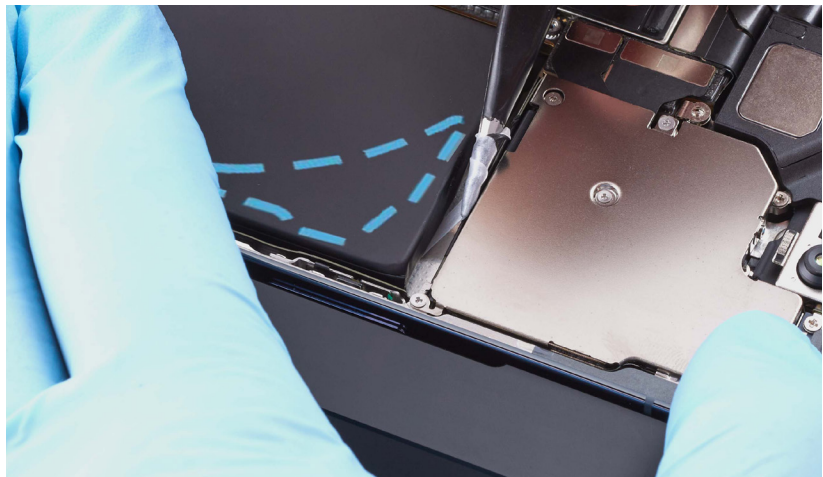
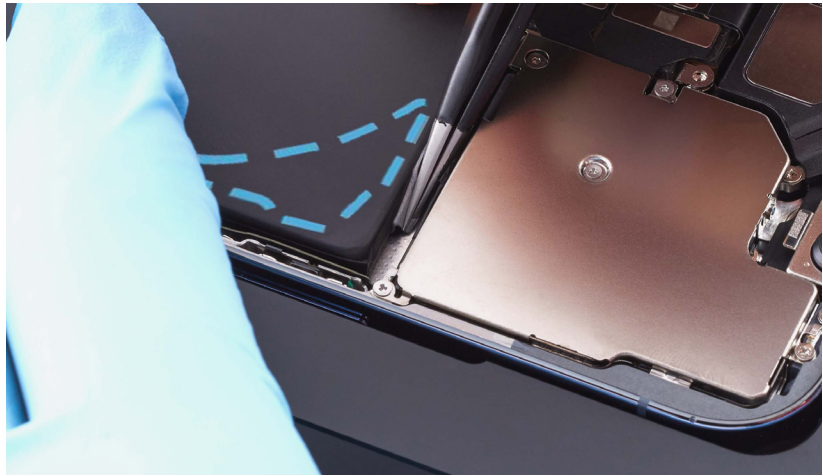

11. If all three battery adhesive strips were fully removed, continue to step 13. If at least one strip was fully removed, continue to step 12.

 **Warning**

If all three strips were broken and can't be retrieved, don't forcibly pry the battery. Stop the repair. You can find a service option at support.apple.com/repair.

 **Caution**

When using the black stick to remove the battery from the enclosure, don't damage the flex cables. Don't scrape, rip, tear, or otherwise damage the polyester film or other areas. If damage occurs, replace the iPhone.

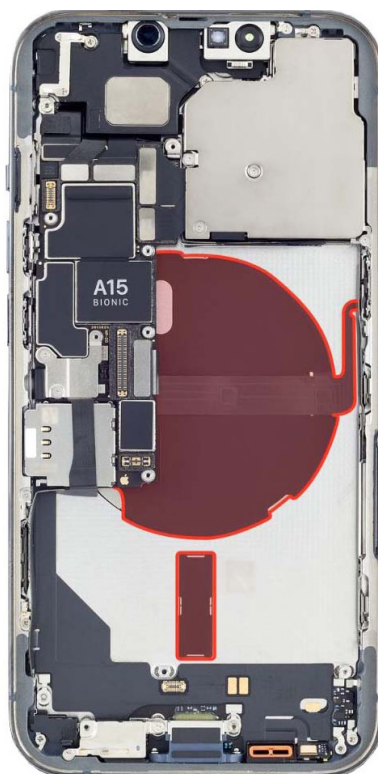

12. Insert the flat end of the black stick into one of the insertion points as shown. Ensure that the black stick is inserted into a point where the battery strip has been fully removed. Don't insert the black stick into a point where the battery tab or strip is broken.



13. Slightly lift the battery with the black stick just enough to grasp underneath the battery.

 **Caution**

To avoid damage, don't press the black stick on the edge of the enclosure as you lift the battery.

14. Remove the battery from the enclosure. Then inspect the enclosure for damage. If the enclosure is damaged, replace the iPhone.

 **Warning**

If you can't remove the battery, stop the repair. You can find a service option at support.apple.com/repair.

Reassembly

1. Reinstall the [Taptic Engine](#).
2. Reinstall the [bottom speaker](#).
3. Use ethanol wipes or IPA wipes on the area shown in blue to remove any remaining adhesive from the enclosure.

Caution

Don't use ethanol wipes or IPA wipes on the areas shown in red. Ethanol or isopropyl alcohol may damage the polyester film and wireless charging unit.

Warning

Inspect the enclosure for loose or extra screws and small parts, which can damage the battery and cause safety issues.

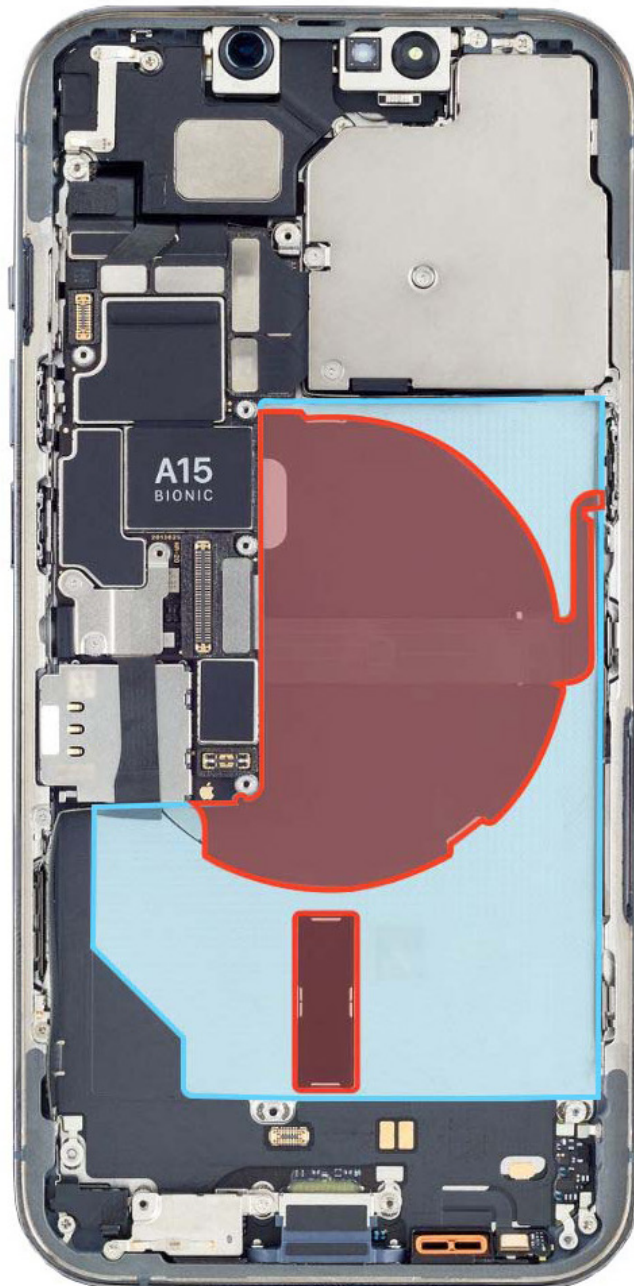

4. Peel the pink release liner from the underside of the replacement battery.

Important

Don't remove the battery protective cover from the top of the battery yet.



5. Hold the battery over the enclosure with the protective cover faceup. Align the bottom of the battery with the bottom speaker (1) and the left edge with the logic board (2). Then lower the battery into the enclosure.

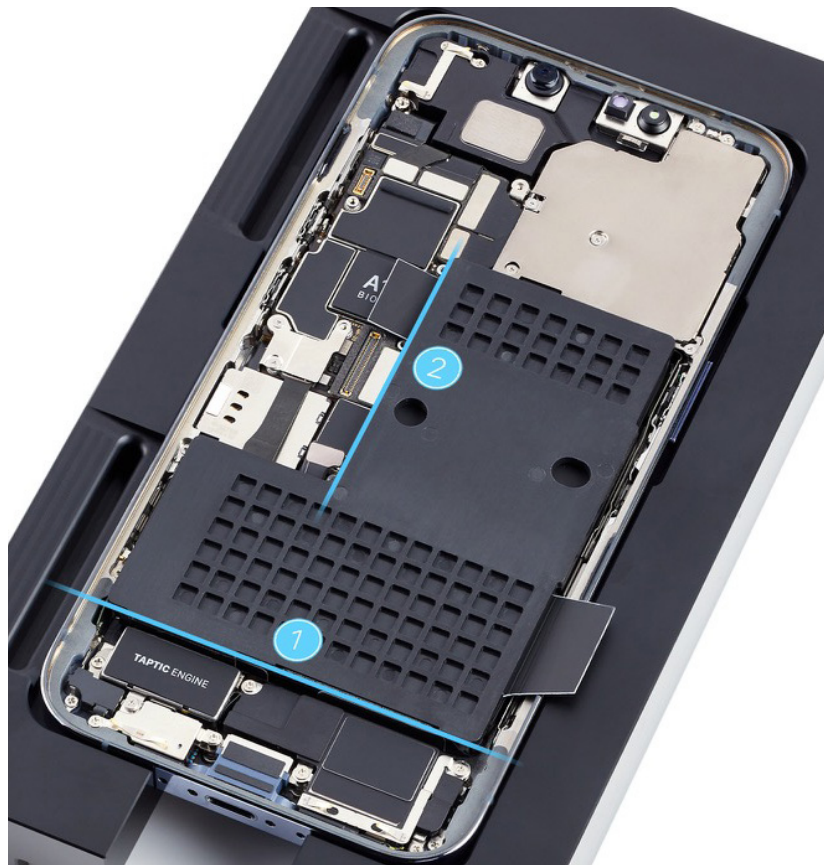

6. Place the repair tray and the enclosure into the battery press. The repair tray has a cutout at the bottom and two slots in the center. Align the left slot on the repair tray with the pin on the battery press.

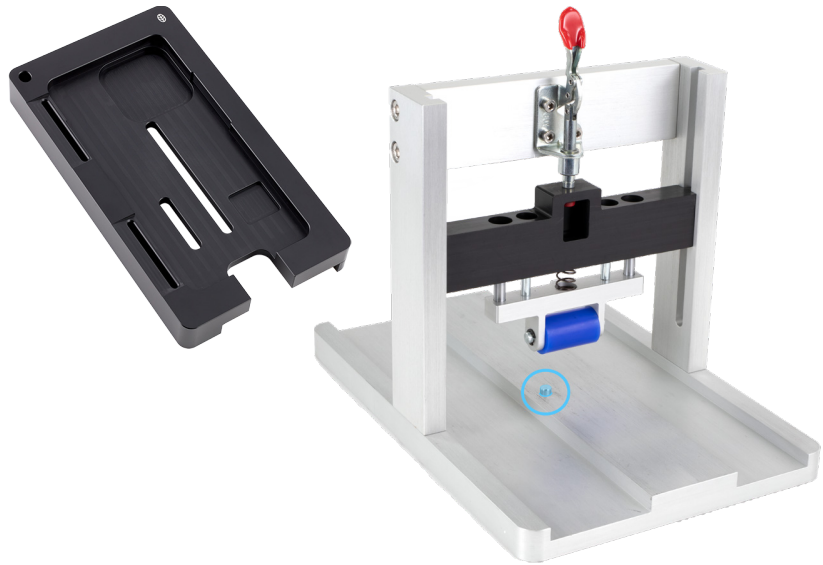

7. Flip down the red lever to lower the roller onto the battery.

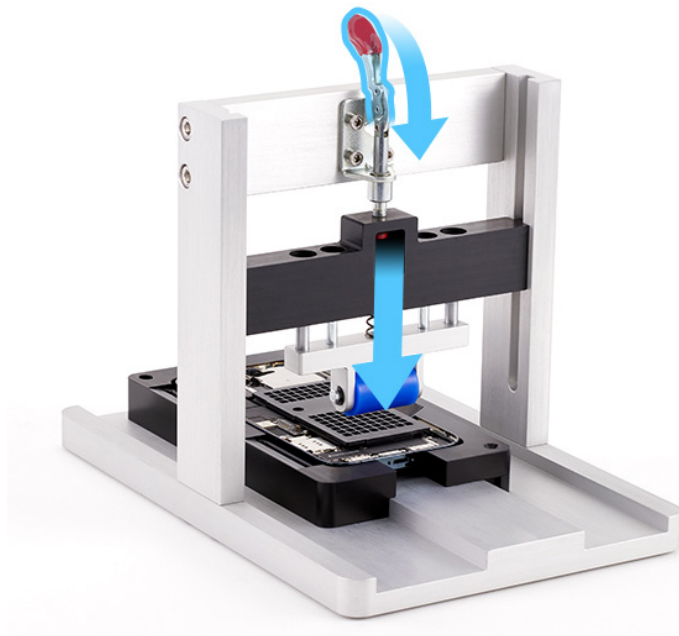

- Slide the repair tray back and forth through the battery press three times to adhere the battery to the enclosure.

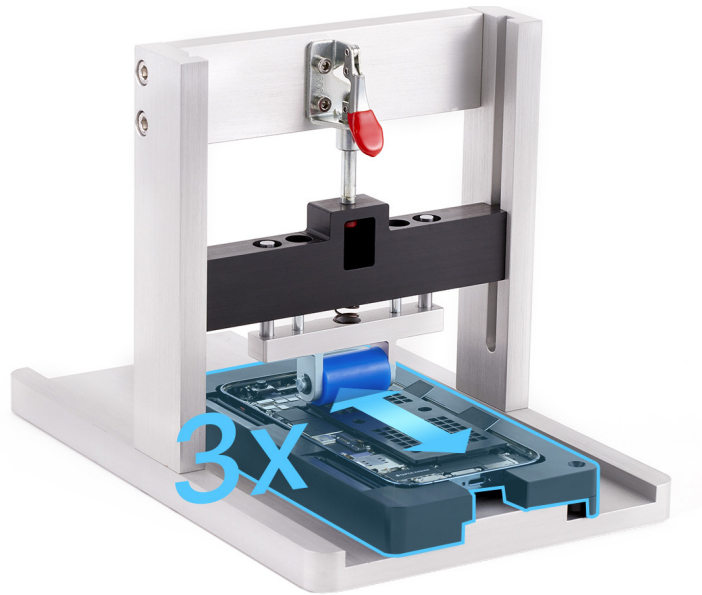

- Flip up the red lever.

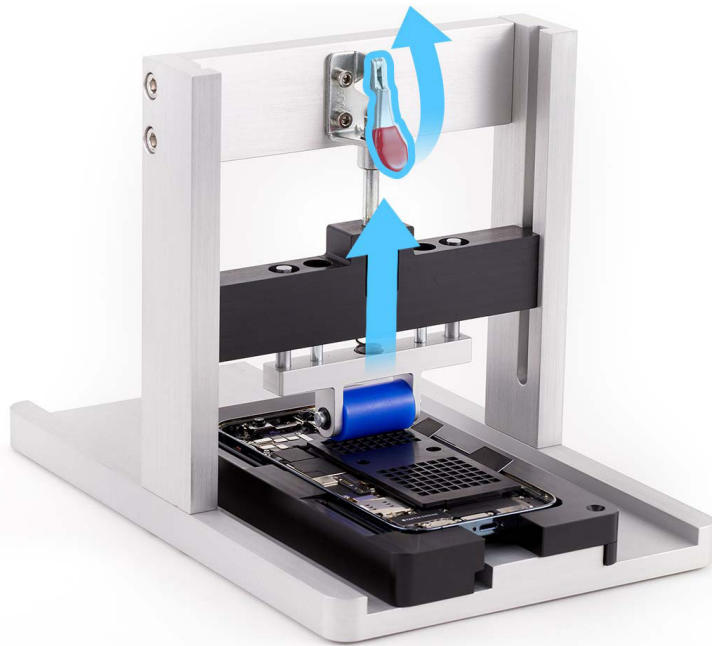

10. Align the right slot on the repair tray with the pin on the battery press.

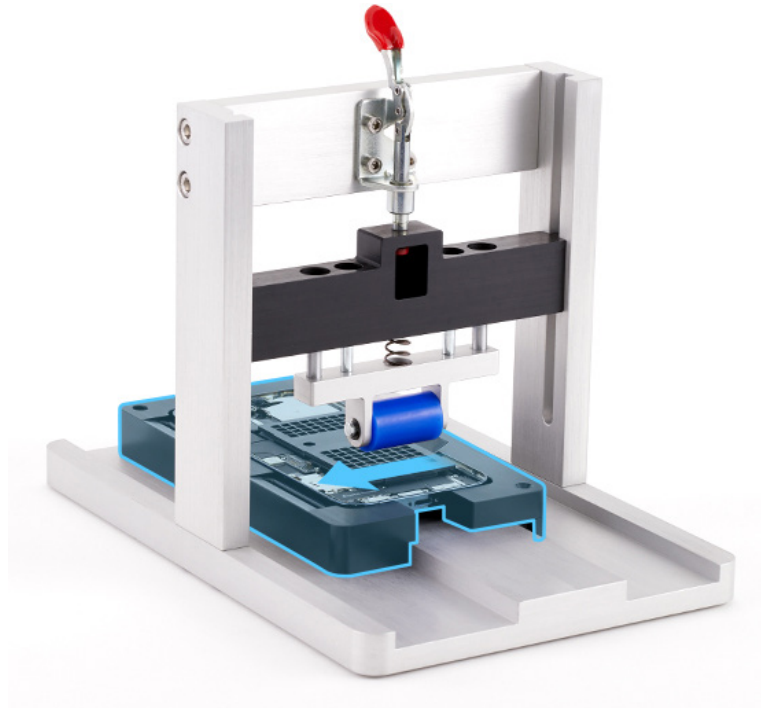

11. Flip down the red lever.

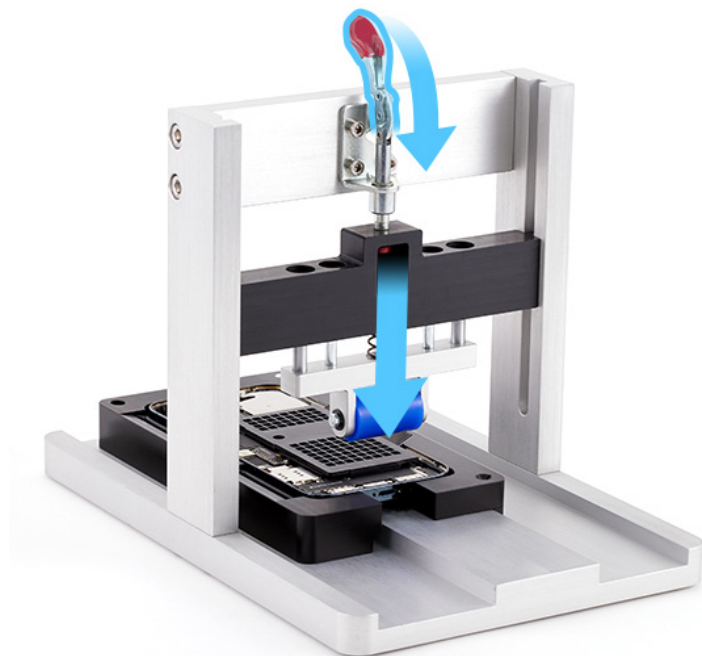

- Slide the repair tray back and forth through the battery press three times to adhere the battery to the enclosure.

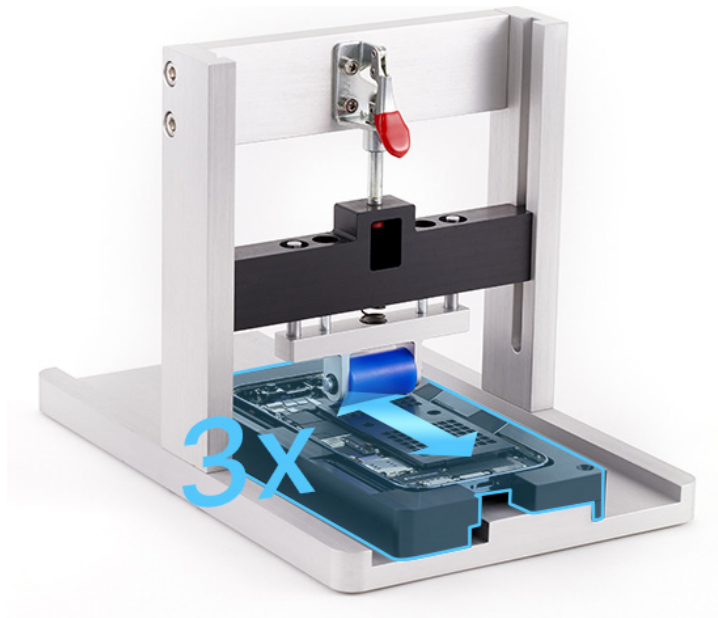

- Flip up the red lever.

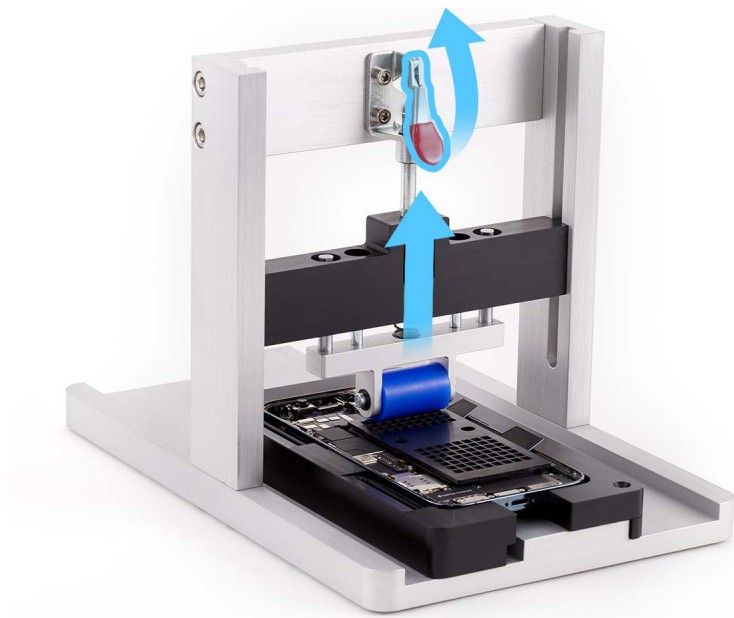

14. Remove the repair tray from the battery press.

15. Hold the edges of the protective cover. Pull the release tabs on the protective cover to remove the cover from the battery.

Important

Don't press the area over the tab you're releasing.



Reinstall the following part to complete reassembly:

- [Display](#)

Warning

Gently shake the iPhone. If the battery sounds loose, remove the [display](#) and the [battery](#). Then complete battery reassembly with another replacement battery.

Important

After you've completed all removal and reassembly steps, learn how to initiate the System Configuration process at support.apple.com/self-service-repair.

Micro stix® is a registered trademark of OSG CORPORATION. Torx® is a registered trademark of Acument Intellectual Properties, LLC.