

Universal Design Guidelines for Outdoor Spaces

Plan and Design for Choice

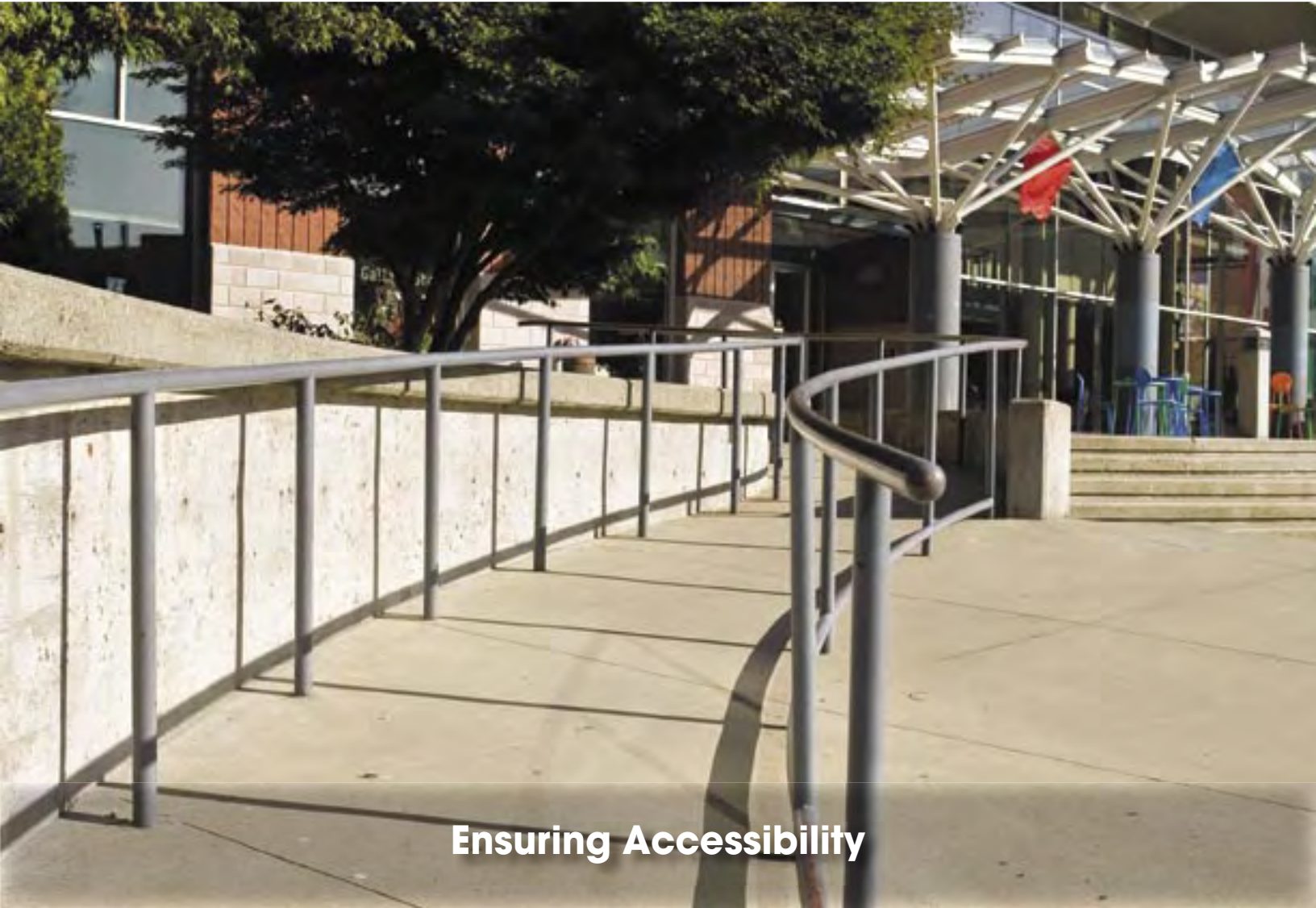

Ensuring Accessibility



Deep Roots
Greater Heights

City of Pitt Meadows



The *Natural* Place

ACKNOWLEDGEMENTS

This publication was developed by the Corporation of the District of Maple Ridge and the City of Pitt Meadows Municipal Advisory Committee on Accessibility Issues (MACAI) in conjunction with Our Designs Inc. Financial support was provided by Measuring Up, an initiative of 2010 Legacies Now and the Province of British Columbia. We thank the Corporation of the District of Maple Ridge and the City of Pitt Meadows for their administrative support.

In addition to the project team, many people were involved in developing and reviewing this publication. We appreciate the suggestions and ideas contributed by our publishing team of Creative-Plus-Solutions, ROC Management and Vancouver Desktop Publishing Centre Ltd.

Plan and Design for Choice

Universal Design Guidelines
for Outdoor Spaces © 2009

Date of Publication: January 2009
First Edition

Project Team:

Donna Rodman, Petra Frederick, Manfred Wuensche, Greg Turnbull, Don Thorogood, Ed (Chum) Richardson, and Maria Kovacs

Graphic Illustrations, Photography and Writing:

Donna Rodman, Our Designs Inc.

Cover Art & Design Layout:

Kim Peterson, Creative Plus Solutions
Front Cover Photo: Natasha MacArthur
Back Cover Photo: Manfred Wuensche

Editing:

Rosemary Teliatnik, ROC Management

Publishing:

City of Pitt Meadows and the District of Maple Ridge.

Many people were involved in developing and reviewing this publication and we are grateful for their contributions. Some of the photographs are of projects carried out by others and some projects were demonstrated as part of conference tours showing the implementation of Universal Design for the twenty-first century. Some of the photographs are those submitted by MACAI committee members as well as by photographers from the Maple Ridge Community.

Material in this publication is available for public use and reproduction. Material, particularly measurements and drawings, must be used as presented without distortions or modifications. The material is not to be used in association with a product, service, cause, or institution without the author's permission.

This publication is available as PDF (free download) from the District of Maple Ridge website www.mapleridge.ca or the City of Pitt Meadows website www.pittmeadows.bc.ca. Paper copies are available by emailing enquiries@mapleridge.ca or calling 604-467-7355.

LEGAL NOTICE

This document is provided without any representations, warranties, or conditions of any kind, express or implied, including, without limitation, implied warranties or conditions concerning this document's fitness for a particular purpose or use, its merchantability, or its non-infringement of any third party's intellectual property rights. Our Designs Inc., the District of Maple Ridge, and the City of Pitt Meadows does not warrant the accuracy, completeness, or currency of any of the information published in this document. Our Designs Inc., the District of Maple Ridge, and the City of Pitt Meadows makes no representations or warranties regarding this document's compliance with any applicable statute, rule, or regulation.

In no event shall Our Designs Inc., the District of Maple Ridge and the City of Pitt Meadows, their volunteers, members, subsidiaries, or affiliated companies or any of their employees, directors, or officers, be liable for any direct, indirect, or incidental damages, injury, loss, costs, or expenses, howsoever caused, including but not limited to special or consequential damages, lost revenue, business interruption, lost or damaged data, or any other commercial or economic loss, whether based in contract, tort (including negligence), or any other theory of liability, arising out of or resulting from access to or possession or use of this document, even if the District of Maple Ridge, City of Pitt Meadows and Our Designs Inc. have been advised of the possibility of such damages, injury, loss, costs, or expenses.

In publishing and making this document available, Our Designs Inc., the District of Maple Ridge, and the City of Pitt Meadows are not undertaking to render professional or other services for or on behalf of any person or entity or to perform any duty owed by any person or entity to another person or entity. The information in this document is directed to those who have the appropriate degree of experience to use and apply its contents, and Our Designs Inc., the District of Maple Ridge, and the City of Pitt Meadows accepts no responsibility whatsoever arising in any way from any and all use of or reliance on the information contained in this document.

Our Designs Inc. is a private, for-profit company, and has no power, nor does it undertake to enforce compliance with the contents of the standards or other documents it publishes or makes reference to in the preparation of this document. Each and every reference is cited for research information in support of recommendations.

Table of Contents

1. Introduction	1	3.3.4 Water Parks	42
Background	2	3.3.5 Outdoor Amphitheatres	43
<i>Figure 1.1 – Universal Design Paradigm</i>	2	3.3.6 Registration & Condiment Counters	43
7 Principles of Universal Design	3	3.3.7 Sailing Facilities & Boat Launches	44
Use of this Document	5	<i>Figure 3.15 – Canoeing and Kayaking Jetty</i>	45
2. Context of booklet	6	3.3.8 Horseback Riding Facilities	46
About The Communities	6	Standard Guidelines for Equestrian Platforms:	47
Intent of Presentation	6	<i>Figure 3.16 – Equestrian Mounting Platform</i>	47
Range of Abilities – Physical & Sensory	7	3.4 Park Services, Trail Signage & Campgrounds	48
<i>Figure 2.1 – Risk Factors / The Disabling Process</i>	7	3.4.1 Washroom Facilities	49
Background Review	8	3.4.2 Outhouses	50
3. Planning & Design/Development Drawings	9	3.4.3 Public Showers	51
Design Criteria	9	3.4.4 Water Taps & Hand Pumps	52
3.1 Pedestrian Circulation	10	Standard Guidelines for Water Taps	
3.1.1 Crossings, Intersections, Walkways & Curbs	11	& Hand Pumps:	52
<i>Figure 3.1 – Warning and Directional Strips</i>	13	<i>Figure 3.17 – Water Taps and Hand Pumps</i>	52
Standard Guidelines for Sidewalks & Intersections	14	3.4.5 Drinking Fountains	53
<i>Figure 3.2 – Crosswalks Intersection with Traffic Circle</i>	16	3.4.6 Benches	54
<i>Figure 3.2A – INSET Traffic Island</i>	16	3.4.7 Trash Receptacles & Recycling Bins	55
<i>Figure 3.2B – INSET Island</i>	16	3.4.8 Lighting	56
<i>Figure 3.3 – Curb Ramp Option 1</i>	17	3.4.9 Battery Recharge Facilities	57
<i>Figure 3.4 – Curb Ramp Option 2</i>	17	3.4.10 Telephones	58
<i>Figure 3.5 – Curb Ramp Option 3</i>	17	3.4.11 Accessible Picnic Tables	59
<i>Figure 3.6 – Curb Ramp Option 4</i>	17	<i>Figure 3.18 – Accessible Picnic Table</i>	60
<i>Figure (3.3 to 3.6)C – INSET Curb Ramp</i>	17	3.4.12 Accessible Campsites	61
Standard Guidelines for Sidewalk Obstructions:	19	Standard Guidelines for Accessible Campsites:	62
<i>Figure 3.7 – Sidewalk Obstruction Elevation View</i>	19	<i>Figure 3.19 – Accessible Campsites</i>	63
<i>Figure 3.8 – Sidewalk Obstructions [Plan View]</i>	20	3.4.13 Walkways & Pathways	64
Standard Guidelines for Multi-Use		3.4.14 Trail Signage	65
Universal Design Pathway or Walkway:	21	Standard Guidelines for Trail Signage:	66
<i>Figure 3.9 – Universal Multi-Use Pathway Crosswalk</i>	22	<i>Figure 3.20 – Trail Signage</i>	67
<i>Figure 3.9A – INSET Universal Multi-Use Pathway</i>	22	3.4.15 Boardwalks (over water)	68
3.1.2 Wayfinding	23	Standard Guidelines for Boardwalks:	69
<i>Figure 3.10 – Wayfinding Model</i>	23	<i>Figure 3.21 – Boardwalk Plan View</i>	69
3.1.3 Seating & Gathering Areas / Rest Areas	24	<i>Figure 3.22 – Boardwalk raised less than</i>	
3.1.4 Ramps, Stairs & Stramps	25	600 mm over water	70
3.1.5 Handrails	28	<i>Figure 3.23 – Boardwalk raised greater than</i>	
<i>Figure 3.11 – Wooden Handrail</i>	28	600 mm over water	70
<i>Figure 3.12 – Handrails and Grab Bar</i>	28	3.4.16 Fishing Platforms	71
3.2 Vehicular Circulation	29	Standard Guidelines for	
3.2.1 Parking Areas	30	Fishing Stations on Dock Facilities:	72
3.2.2 Accessible Parking Lot / Stalls	31	<i>Figure 3.24 – Fishing Dock Elevation View</i>	73
3.2.3 Bus Stops	32	<i>Figure 3.25 – Fishing Dock Plan View</i>	73
Standard Guidelines for Bus Stops:	33	Standard Guidelines for	
<i>Figure 3.13 – Bus Stops</i>	34	Fishing Stations in Natural Settings:	74
3.2.4 Drop-Off & Pick-Up Areas	35	<i>Figure 3.26 – Fishing Dock Elevation</i>	74
Standard Guidelines for		3.4.17 Beaches	75
Drop-Off & Pick-Up Areas:	36	3.4.18 Outdoor Pool Decks	76
<i>Figure 3.14 – Drop-Off & Pick-Up Areas</i>	36	4.0 Conclusions, Bibliography & Glossary	77
3.3 Recreation Facilities & Outdoor Spaces	37	Conclusions	77
3.3.1 Public Building Entries & Arrival Areas	38	Bibliography	78
3.3.2 Doors, Door Handles & Thresholds	39	Glossary of Terminology	78
3.3.3 Children's Play Areas	40		

1. Introduction

A community which is planned and designed to accommodate all of its citizens celebrates potential, quality of life, and diversity of ability. Such a community also reaps social and financial benefits when citizens can enter businesses, cross streets, attend games and concerts, or participate in outdoor recreation. The organizational model called Universal Design combines accessibility, adaptability, inclusivity, and freedom from barriers to allow “all degrees of sensory awareness, all types of movement, and all levels of physical and intellectual function.” (PLAE Inc. 1993)

Ron Mace, FAIA, (1985) who pioneered and passionately promoted the concept of Universal Design, changed the minimum standards for building codes to “incorporate products as well as building features, which to the greatest extent possible, can be used by everyone.” Today, plans which follow the Universal Design model, for objects and spaces used by the public, integrate elements that address as many needs as possible to accommodate the broadest spectrum of users instead of select groups. Two examples of Universal Design are the accessible picnic table and the common accessible ramp used in conjunction with stairs. Both are usable by most people regardless of ability.

Outdoor or natural areas offer unique challenges as well as special opportunities for planners, engineers, and designers. Many outdoor spaces are neither accessible to, nor usable by, a large cross section of people. Our natural environment does not always lend itself to manipulation as easily as built structures do. The contemporary emphasis on green sustainable design stresses sensitivity to natural land formations, topography, and ecosystems. In spite of these challenges, many natural settings can be made available to more users with modifications that do not detract from their natural characteristics. When natural areas and open spaces are altered, they more easily accommodate a larger part of the population including seniors, people with disabilities, and parents with children. Any combination of consumer groups can also be served by applying Universal Design Principles. The user groups can then be expanded to include: seniors with hearing and visual impairments, parents with disabilities with children, parents with children with disabilities, and people with multiple disabilities who also use guide dogs and/or assistive dogs.

1 Introduction

Background

Events and concepts contributing to the Universal Design paradigm are illustrated in Figure 1.1. The origin of the paradigm occurred at the end of the First World War, when the vocational rehabilitation of veterans became a world-wide concern. Many veterans needed to reintegrate into the workforce, and therefore needed adapted spaces. The movement to provide these spaces quickly became the impetus to provide the same access for adults with disabilities, and thereafter to include children with disabilities. The United States developed its First National Standard for public access – ANSI A117.1 – in 1961. Soon, the social trend to provide access to public spaces, and to return people to the family sphere by making their homes more suitable to their challenges, made visitability, accessibility and barrier-free home design increasingly important. Market trends, demographics, and environmental studies caused planners, consultants, and designers a great deal of confusion as to what accessibility meant, who it was applicable to, and how to integrate access during the evolution of Universal Design. Adaptability and adequate criteria were put forward to mitigate

the economic impacts of retrofitting pre-built-code buildings, or addressing after-market costs of building homes that could accommodate consumers with multiple abilities. While North America was evolving in Barrier-Free and Accessible Design, South America (Inclusive Design) and Europe (Visitability) were addressing their communities.

In Canada, in 1982, the Charter of Rights and Freedoms guaranteed people with disabilities the right to participate fully in all educational and recreational activities. Contemporary implementation of this charter, in combination with provision of inclusive employment opportunities (such that businesses are fully able to hire people with disabilities), ensures that the major cornerstones for a society to be inclusive of everyone are in place.

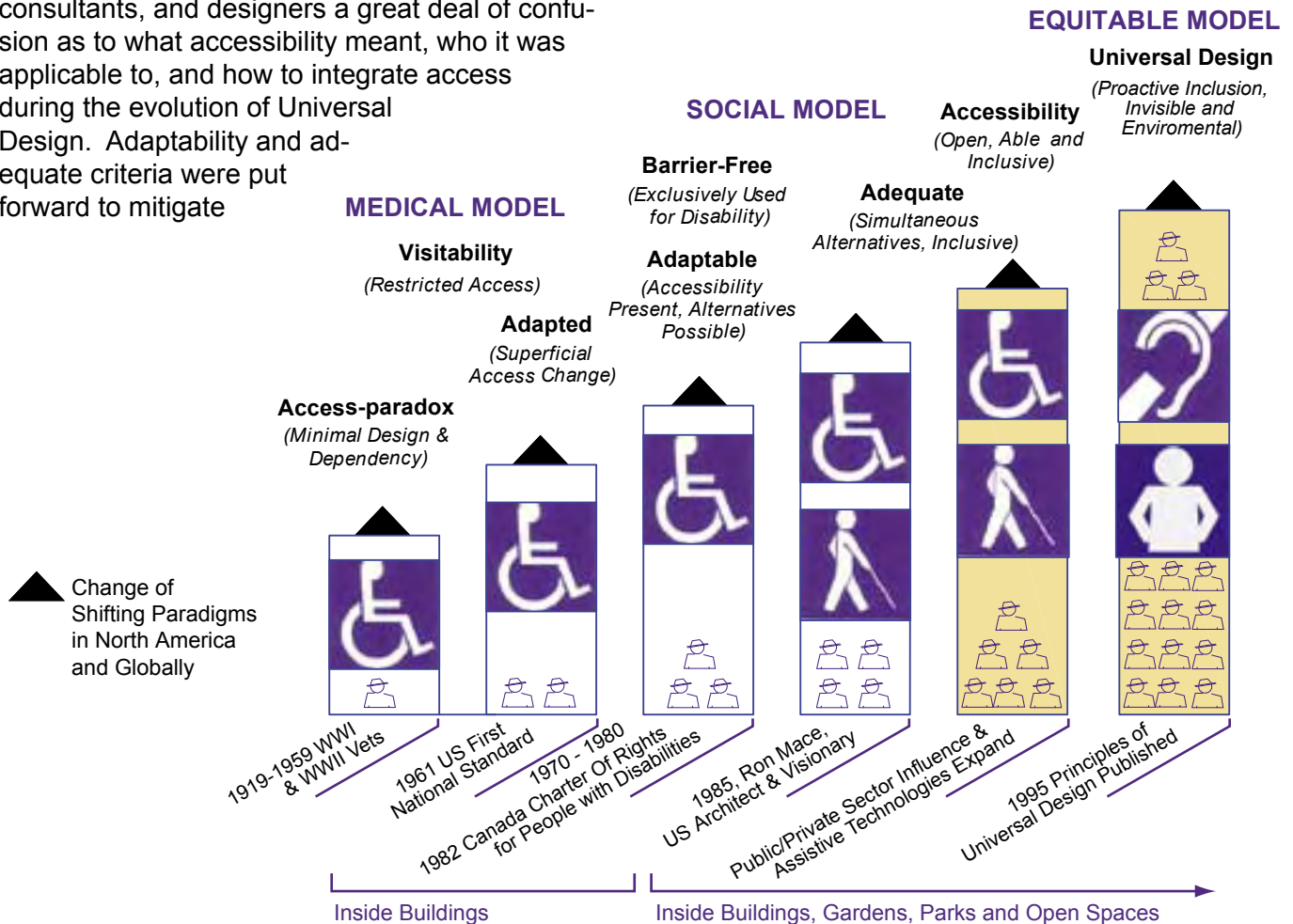

Figure 1.1 – Universal Design Paradigm

Throughout the community of Universal Design consultants and researchers, there are multiple definitions of Universal Design. Some definitions are broader, some are narrower, and some emphasize certain aspects over others. None are perfect and consensus is not possible despite attempts to come to agreement. However, there are seven guiding Principles for Universal Design, published by the Center for Universal Design at North Carolina State University in December, 1995. These principles come with the caveat that all guidelines may not be relevant to all designs. Every site is unique, whether that site is a store front or a pathway system mounting a dike pathway; so the principles are purposefully generic and allow for performance-based design and planning, rather than prescriptive formats.

These principles offer designers guidance to better integrate features that meet construction practices.

(Excerpt from website: NC State University: The Center for Universal Design)

ONE:

Equitable Use

The design is useful and marketable to people with diverse abilities.

Guidelines:

- 1a. Provide the same means of use for all users: identical whenever possible; equivalent when not.
- 1b. Avoid segregating or stigmatizing any users.
- 1c. Provisions for privacy, security, and safety should be equally available to all users.
- 1d. Make the design appealing to all users.

TWO:

Flexibility in Use

The design accommodates a wide range of individual preferences and abilities.

Guidelines:

- 2a. Provide choice in methods of use.
- 2b. Accommodate right- or left-handed access and use.
- 2c. Facilitate the user's accuracy and precision.
- 2d. Provide adaptability to the user's pace.

THREE:

Simple and Intuitive Use

Use of the design is easy to understand, regardless of the user's experience, knowledge, language skills, or current concentration level.

Guidelines:

- 3a. Eliminate unnecessary complexity.
- 3b. Be consistent with user expectations and intuition.
- 3c. Accommodate a wide range of literacy and language skills.
- 3d. Arrange information consistent with its importance.
- 3e. Provide effective prompting and feedback during and after task completion.

FOUR:

Perceptible Information

The design communicates necessary information effectively to the user, regardless of ambient conditions or the user's sensory abilities.

Guidelines:

- 4a. Use different modes (pictorial, verbal, tactile) for redundant presentation of essential information.
- 4b. Provide adequate contrast between essential information and surroundings.
- 4c. Maximize "legibility" of essential information.
- 4d. Differentiate elements in ways that can be described (i.e., make it easy to give instructions or directions).
- 4e. Provide compatibility with a variety of techniques or devices used by people with sensory limitations.

FIVE:

Tolerance for Error

The design minimizes hazards and the adverse consequences of accidental or unintended actions.

Guidelines:

- 5a. Arrange elements to minimize hazards and errors: most used elements, most accessible; hazardous elements eliminated, isolated, or shielded.
- 5b. Provide warnings of hazards and errors.
- 5c. Provide fail safe features.
- 5d. Discourage unconscious action in tasks that require vigilance.

SIX:

Low Physical Effort

The design can be used efficiently and comfortably and with a minimum of fatigue.

Guidelines:

- 6a. Allow user to maintain a neutral body position.
- 6b. Use reasonable operating forces.
- 6c. Minimize repetitive actions.
- 6d. Minimize sustained physical effort.

SEVEN:

Size & Space for Approach & Use

Appropriate size and space is provided for approach, reach, manipulation, and use regardless of user's body size, posture, or mobility.

Guidelines:

- 7a. Provide a clear line of sight to important elements for any seated or standing user.
- 7b. Make reach to all components comfortable for any seated or standing user.
- 7c. Accommodate variations in hand and grip size.
- 7d. Provide adequate space for the use of assistive devices or personal assistance.

Please note that the Principles of Universal Design address only universally usable design, while the practice of design involves more than consideration for usability. Designers must also incorporate other considerations such as economic, engineering, cultural, gender, and environmental concerns in their design processes. These Principles offer designers guidance to better integrate features that meet the needs of as many users as possible, and are provided here to start you thinking about the process to launch design standards and construction practices.

Use of this Document

Our Designs Inc. was retained to prepare this booklet as a reference guide on the Universal Design of outdoor spaces for the District of Maple Ridge and the City of Pitt Meadows. It is to be used by builders/developers/contractors and city personnel to develop design and construction standards.

It is recommended that all parks design, planning, engineering, operations, and maintenance staff read the full document. Each section has detailed descriptions of factors to consider when designing or planning new developments or redeveloping existing sites.

Relevant references to various building codes, standards, and publications are listed at the end of the booklet and are to be considered as information references for further research by staff. In areas where references are cited, it is important to update and keep current with changes and revisions to these standards where they affect accessibility. This is particularly true of the *British Columbia Building Code (BCBC)*. Where the design guidelines are conceptual, then the BCBC and the Canadian Standards Association (CSA) are to be referred to as precedent and minimum requirements. Our Designs Inc. recommends obtaining copies of the CSA document entitled *Accessible Design for the Built Environment, B651-04* and the *Building Access Handbook 2007* published by the B.C. Office of Housing and Construction Standards. Additional information can be found in the United States' document, *The Americans with Disabilities Act (ADA)*.

This booklet was designed to deal with issues and conditions rather than defining specific construction standards for Universal Design. Planning and design staff are to combine abilities to create quality design that meets site-specific constraints using a performance based approach to the design process. There are many ways to design most of the elements referred to in this publication. What is important is the adherence to the Principles of Universal Design. The intent of the document is also to establish Universal Design Standards which will raise the bar, in the current evolutionary stage of Universal Design. At this stage, these guidelines and recommendations are basic to implementing Universal Design in new development or redevelop-

ment of outdoor spaces, including amenity spaces that are part of residential and multi-family residential developments.

Where we speak of disability in this publication, our intent is to reinforce that Universal Design promotes the concept of ability. The terminology of working language has been such that we have created a language around *people with disabilities* as a distinction of disability rather than the positive implication of *people with abilities*. Throughout this publication, we would like to be understood as considering *disability* as an *ability* with a proactive, positive intention.

How to Use the Checklist

Universal Design is achievable by making small, simple changes to the physical environment. A checklist format has been designed to aid in conducting a survey and prioritizing access features. This booklet does not define how much effort and expense are needed and you must use your judgment on a case-by-case basis. Size, type, function, and overall financial resources available to a facility can be weighed against the nature and cost of the access improvements needed. The checklist is designed to be simple but allow for the user to think whether the item of access is possible to do.

The effort of determining what changes are readily achievable is not a one-time event; access should be re-evaluated annually because what was not possible to change now, might be changed at another time when better incentives are in place. If you cannot comply with the CSA or ADA now, then the checklist can be used to make readily achievable modifications that do not fully comply, using less stringent standards, as long as the modifications do not pose a health or safety risk. The checklist is really to be used for getting started in a preliminary survey for removing barriers and setting priorities for improvements.

Our caveat is that the checklist **does not** cover all of the CSA, BCBC, or ADA requirements and therefore is **not** to be viewed as a code compliant checklist for the BCBC nor does it cover all items necessary for new construction or facilities undergoing new renovations under the current BCBC.

2

Context of Booklet

2. Context of Booklet:

About The Communities

Maple Ridge and Pitt Meadows are located in a rural, relatively flat land setting amidst forests, farmlands, rivers, and streams, and between mountains and plateaus that form part of the Fraser Valley. They are in a peaceful area that is quickly moving from a small town atmosphere to a blended municipality of pocketed subdivisions separated by natural open spaces. The region has a moderate climate with some seasonal variations in temperature and experiences long frost-free periods. Such characteristics give these communities one of the longest growing seasons in Canada. These are communities where topography and climate come together, attracting an aging Canadian population and people with disabilities. The vibrancy of the community is significant and thriving as families with children move out of Vancouver and other parts of the Lower Mainland into the more affordable housing communities being developed. The quality of life is greatly supported by a strong consciousness for environmental stewardship that firstly seeks to protect and enhance the natural qualities of the river and shoreline areas, and, secondly, protects residences and businesses from hazards which may be associated with floodplains and unstable hill slopes.

Intent of Presentation

Universal Design requires providing a range of services and amenities that ensure each person's experience is not restricted. Getting to this point in design is a function of attitude, philosophy, and commitment to accessibility. Because technologies change quickly, and individual abilities vary so greatly, planners, engineers, and designers can no longer make assumptions of who will be able to get to and enjoy a particular urban or rural site. Where possible, we seek to provide full universal access through development, redevelopment, and retrofit initiatives throughout the communities of Maple Ridge and Pitt Meadows.

Range of Abilities - Physical & Sensory

To fully respond to the design implications of achieving universal access, it is important to understand that “disability” is the product of a complex interactive process involving biological, behavioural, and environmental (social and physical) factors that impact quality of life.

Risk Factors:

Biological, environmental (social and physical), and lifestyle or behavioural characteristics that are causally associated with health-related conditions are risk factors. If we consistently design curb cuts and ramps to the minimum of 1:12 or 8.33%, we are running the risk of further damage to the shoulder joints of users of wheelchairs as they have to work hard to roll up a ramp to get from point A to B. The effort and strain eventually results in pain and weakness, making it difficult to roll up even smaller grade changes. Where possible, reducing the slope of curb cuts and ramps or, better yet, safely eliminating them by regrading a site feature so they are not necessary, helps reduce such a risk factor.

Quality of Life:

Research indicates that a person’s perception of quality of life influences his or her response to potentially disabling conditions and outcomes. Each stage in the disabling process increases the threat of a diminished quality of life. Modifying the work site or entry point, and providing assistive technologies to facilitate this, enables an individual to continue their working life and remain independent in at least a familiar role that accommodates their new abilities. Such interventions help to prevent the disabling process.

The Disabling Process:

A variety of personal, societal, and environmental factors can cause a disabling condition to progress from an acute incident, to chronic condition, to pathology, to disability. The occurrence of secondary conditions such as respiratory ailments, loss of hair, poor hygiene, and fatigue are prevalent indicators of health status, psychological state, socioeconomic status, educational attainment, vocational training, climate, and the presence of multiplying conditions. In some cases, clusters of disabilities develop in one person, for example visual impairments and hearing impairments, that cascade into learning difficulties, misinterpretation of environment, and difficulties in wayfinding.

RISK FACTORS

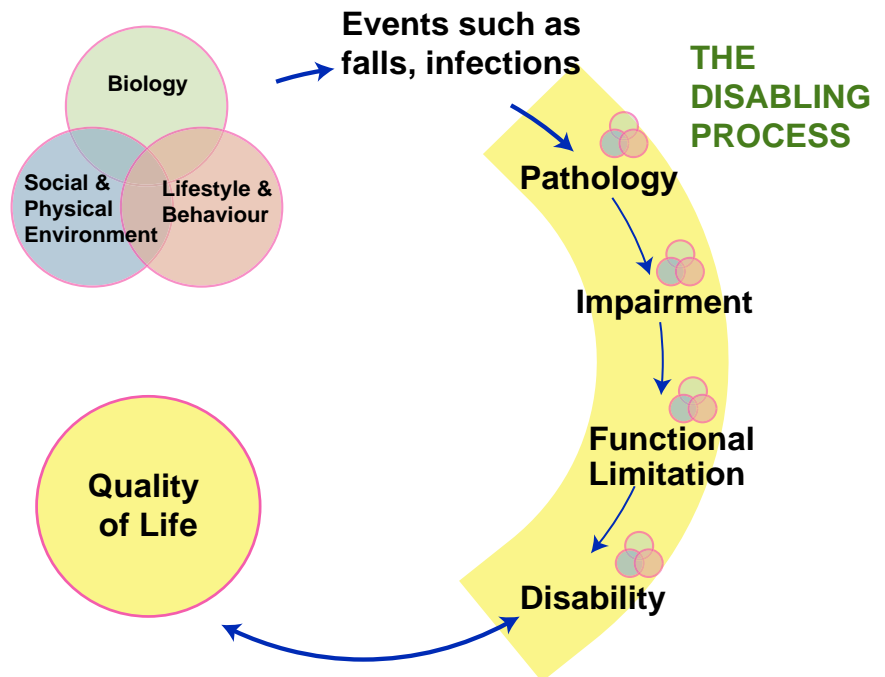

Model of disability, showing the interaction of the disabling process, quality of life, and risk factors. (Source: Institute of Medicine, 1991)

Figure 2.1 – Risk Factors / The Disabling Process

The range of physical ability varies from the person who uses a wheelchair (non-ambulatory) and those with other mobility difficulties (semi-ambulatory) using scooters, walkers, canes, and braces, to those who also may have heart, lung, and arthritic conditions.

Sensory disabilities can be visual impairments and hearing impairments. Visual impairment can be defined as an inability to read regular-sized print, or see someone from 4 metres away, even when wearing corrective lenses. Legal blindness is defined as having less than 10% vision with corrective lenses. Other visual impairments include blurred vision (cataract), patchy vision (diabetic retinopathy), colour blindness, reduced field of vision that includes central field vision loss (macular degeneration), and peripheral field of vision loss (glaucoma, retinitis pigmentosa).

Hearing impairments can be defined as an inability to hear what is being said in conversation with one or more persons – even when wearing a hearing aid. It can include partial and total hearing loss.

[Environment Canada Parks Service, Access Series 1991]

Background Review

A bibliography containing a list of documents, standards, reports, and literature used and reviewed to prepare this publication is included in Section 4. In addition, the District of Maple Ridge and the City of Pitt Meadows Municipal Advisory Committee (MACAI), the Center for Universal Design in North Carolina, and the Canadian National Institute for the Blind were consulted during the drafting for input and comment.

Comments about the literature materials reviewed:

- Documents focused on selected barrier-free issues and did not illustrate an understanding of how to comprehensively interrelate the various user groups.
- There was little attention paid to the open space and outdoor issues such as topography, or to connectivity between sidewalk, transition zones, road crossings, and destination features for wayfinding to the features.
- The integration of sustainable design components with actual design graphics was lacking and required careful assimilation and editing to summarize the main points of sustainable landscape construction.

Design Criteria

The field of anthropometrics provides information about the dimension and functional capacity of the human body. Dimensional variation occurs in the data because of the broad range of diversity in the human population. The factors that cause human variations are gender, age, ethnicity, and race. Much of the anthropometric data that architects are familiar with is based on space and access charts designed to accept the 97.5 percentile man and woman.

Designers should be familiar with how to read anthropometric data; however, in the work of Universal Design, such data can only be used as a guideline for such basic spatial dimensions as required to accommodate people using wheelchairs and other mobility aids. Most anthropometric data offered in publications addressing accessibility focus on the person using a wheelchair and can be fundamentally difficult to set standards to or interpret. Universal Design works to create designs that address the needs of the larger consumer group, and includes people with various disabilities as part of that population, thus reducing the need to design based on anthropometrics. Universal Design takes into account the fact that people come in a variety of shapes, sizes, abilities/disabilities, and ages. Planning and designing using widths, lengths, and dimensions that accommodate a wide range of people assures access to recreational facilities and programs for all visitors.

Various codes and standards have been developed globally and each one approaches the anthropometric data differently. For our Canadian population, the following are the best sources of reference information to be used as basic, informative guides:

Canadian Standards Association, Accessible Design for the Built Environment, B651-04, [2004] [Annex B, Anthropometrics]. Available in their Online store at www.ShopCSA.ca

Ringaert, L., Rapson, D., Qui, J., Cooper, J., and Shwedyk, E. Determination of New Dimensions for Universal Design Codes and Standards with Consideration of Powered Wheelchair and Scooter Users. Winnipeg: Universal Design Institute (Faculty of Architecture, University of Manitoba), 2001.

3.1

Pedestrian Circulation

3.1 Pedestrian Circulation

3.1.1 Crossings, Intersections, Walkways & Curbs 11

Figure 3.1 – Warning and Directional Strips 13

Standard Guidelines for Sidewalks & Intersections - p14

Figure 3.2 – Crosswalks Intersection w/ Traffic Circle 16

Figure 3.2A – INSET Crosswalk showing Traffic Island 16

Figure 3.2B – INSET Crosswalk Island 16

Figure 3.3 – Curb Ramp Option 1 17

Figure 3.4 – Curb Ramp Option 2 17

Figure 3.5 – Curb Ramp Option 3 17

Figure 3.6 – Curb Ramp Option 4 17

Figure (3.3 to 3.6)C – INSET Curb Ramp 17

Standard Guidelines for Sidewalk Obstructions - Bollards - p19

Figure 3.7 – Sidewalk Obstructions Elevation 19

Figure 3.8 – Sidewalk Obstructions Plan View 20

Standard Guidelines for Multi-Use Universal Design Pathway or Walkway - p21

Figure 3.9 – Universal Multi-Use Pathway Crosswalk 22

Figure 3.9A – INSET Universal Multi-Use Pathway 22

3.1.2 Wayfinding 23

Figure 3.10 – Wayfinding Model 23

3.1.3 Seating & Gathering Areas / Rest Areas 24

3.1.4 Ramps, Stairs & Stramps 25

3.1.5 Handrails 28

Figure 3.11 – Wooden Handrail 28

Figure 3.12 – Handrails and Bar Grab 28

3.1 Pedestrian Circulation: 3.1.1 Crossings, Intersections, Walkways & Curbs

Crosswalk – North Vancouver, B.C. / photo credit: Donna Rodman



- Areas between sidewalks and intersections are dangerous. Each intersection is unique to its site's constraints and traffic patterns. Cars, buses, and trucks have power to frighten and subdue pedestrians who have the legal right of way. No amount of painted lines, traffic signs, or button operated signals, ever quite manages to change the fact that a car weighs a ton or more, and will run over any pedestrian unless the driver brakes. Signs and barriers are insufficient to prevent intrusions by turning vehicles, including bicycles, cutting across the rollover curbs.
 - The safest crosswalk is where curb ramps lead people directly into the crossing area designated for pedestrian use, and these crosswalks are at 90° to each other. Right-angled crosswalks, aligned opposite each other, if consistently used, provide predictability to the person with a visual impairment. Where possible, curb ramps are to be located at the side of the crosswalk farthest from the centre of the intersection. This creates a buffer area between the person in a chair who is less able to move out of the way of a turning vehicle, and ambulating person who could quickly move out of the way of a turning vehicle.
 - Traffic calming designs improve neighbourhood liveability and accessibility for pedestrians by reducing vehicle speeds at intersections.
- Slowing vehicles down and encouraging the sharing of streets, reduces traffic volume, noise, and impact. Pedestrians are more visible as motorists sense they are intruding into a pedestrian zone. Crosswalks incorporated with horizontal deflectors that narrow roadways provide an enhanced safety zone when the user is crossing over the curb ramp and before they cross into the painted crosswalk zone. Such horizontal deflectors create lateral changes in the road that not only permit curb ramps but also allow for landscape beautification on either side of the curb ramp and intersection.
- Diagonal curb ramps are permitted but are not considered to be safe. They must have returned curbs with well-defined edges being parallel to the direction of pedestrian flow. To modify an existing diagonal curb ramp, it is recommended to put up either a rail barrier or a hazard tactile strip around the curve to prevent a person with a visual impairment from heading down the curb ramp to the centre of the intersection. Failing this, a beautification effort with tactile materials or planter barriers can suffice. Options 1 and 2 [Fig. 3.3 & 3.4 p17] are solutions for retrofitting existing curb ramps.

3.1 Pedestrian Circulation: 3.1.1 Crossings, Intersections, Walkways & Curbs

- If a curb ramp is located where pedestrians must walk across the ramp, it shall have flared sides. The ADA prescribes a maximum slope of 10% on the flared sides whereas the latest CSA standards recommend a slope with a ratio of 6.66% and that 10% slopes are to be avoided as persons using scooters and wheelchairs can tip over while trying to wheel across such a curb ramp or a driveway letdown. The distance of 920 mm [3'], as illustrated in Options 1 to 4 [Fig. 3.3 to 3.6 p17], must apply so that there is as level a transition from sidewalk to curb ramp as possible.
- Colour contrasted tactile warning strips and directional guiding strips are to be used with discretion, especially at the approaches to intersections, transition areas to ramps, stairs, and around and before obstructions that are in the direct line of travel. This applies to walkways, multi-use universal trails, and sidewalks.
- Directional guiding strips do not have to lead a person down the curb ramp. They can be set aside of the curb ramp but they must end with a tactile warning strip prior to the roadway curb. Directional guiding strips are not to impede use of the curb ramp by people using wheelchairs or scooters, though everyone will still need to cross the tactile warning strip integrated in the top and bottom of the curb ramp in Option 2 [Fig. 3.4 p17]. The use of one brick depth 200 mm or 330 mm [8" or 13"] is to reduce the discomfort of muscle spasms created by rolling over the irregular surface of a tactile warning strip.
- Diagonal curb ramps (a.k.a. curb fans) have appeared in our communities. Provided acceptable hazard indicators and/or barriers are in place, they can be helpful in creating an accessible sidewalk. Options 3 and 4 [Fig. 3.5 & 3.6 p17] are examples of acceptable solutions. The creation of a buffer 1220 mm [4'] deep between painted markings is critical in Option 3 [Fig. 3.5 p17]. As a person in a wheelchair gains momentum on a curb ramp, they may end the run on the roadway between crosswalks. Installing bollards gives some degree of protection at a corner curb ramp but evidence of bollards knocked over or damaged

*Crosswalk with Bollard – Pitt Meadows, B.C.
photo credit: Petra Frederick*

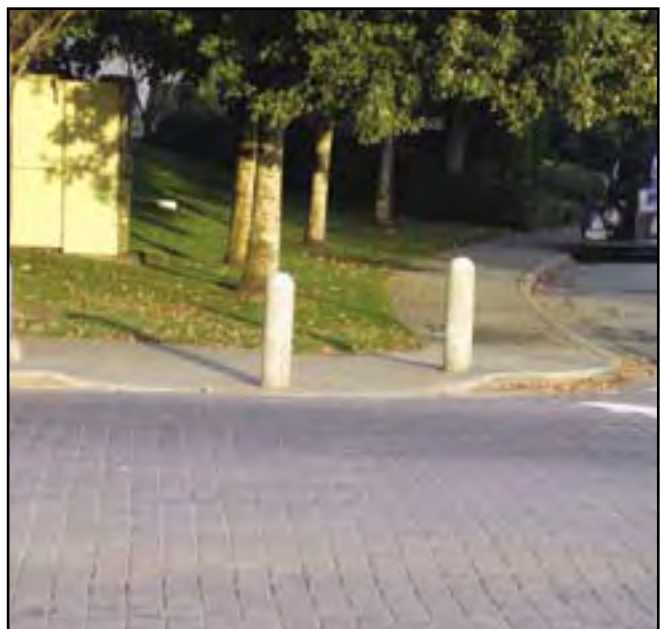

by impact does not leave an impression that the corner is safe.

- Option 4 [Fig. 3.6 p17] has a raised 6" curb plus a tactile warning triangle. A car must mount the curb to run over the curb ramp and the pedestrian must have ignored the tactile warning triangle to stand at, or roll to, the corner of the road. Option 4 [Fig. 3.6 p17] is the best Universal Design option for directing pedestrians to crosswalks.
- With the placement of the directional tactile strips on both Options 3 and 4 [Fig. 3.5 & 3.6 p17], a person in a wheelchair can roll to a smooth, slip-resistant surface between the first line of tactile and directional strips, and swing down the ramp. They only cross one tactile hazard strip at the bottom of the curb ramp.

3.1 Pedestrian Circulation: 3.1.1 Crossings, Intersections, Walkways & Curbs

- Tactile warning strips are now required by the ADA and truncated domes are the only detectable warnings allowed. In addition, the colour of the detectable warning should contrast visually with adjoining surfaces; either light on dark, or dark on light, and the contrast value should be at least 70% and a formula is in place to determine this. The CSA provides an additional contrast value for yellow, as the colour of paint should contrast at least 40% with the surrounding surface.

- There are tactile warning systems that include built in LED displays for night vision. These advanced systems can only be considered if the cost of maintenance of the system is covered. There is no sense in installing LED displays for a few years and then removing them. The consequences to people with disabilities who rely on these advanced systems, and suddenly are found without them, can result in unsafe navigation, wayfinding, and accidents.
- V-grooves cannot be reliably detected by people with visual impairments and should not be used as a substitute for detectable warnings. Cane users may confuse them with the grooves between sidewalk panels and cracks in the sidewalk.
- Walkways and sidewalks shall be free of overhead, low-level obstacles such as branches, signage, or site furnishings. Overhead clearance dimensions should be a minimum of 2.03 m [6' 7"] (CSA standard) or 1.98 m [6' 6"] (BCBC). Most planners and designers prefer to adhere to the 2030 mm [6' 7"] overhead clearance. Guy wires and awnings are often overlooked as being overhead obstructions and shall be taken into account.

Figure 3.1 – Warning and Directional Strips

Tactile Warning Strip

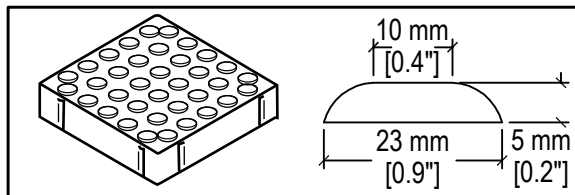

Directional Tactile Strip

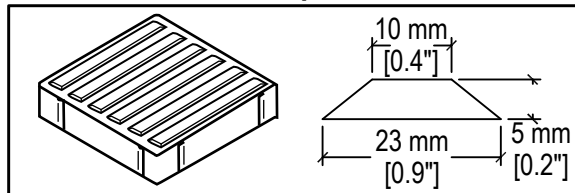

LENGTH	300 mm or 12" approx. (also avail. 24"x24")
WIDTH	300 mm or 12" approx. (also avail. 24"x24")
DEPTH	8 cm or 3"
WEIGHT	kg 22.6 approx.
COLOUR	Variety available; colour contrast of 70% to pavement adjacent

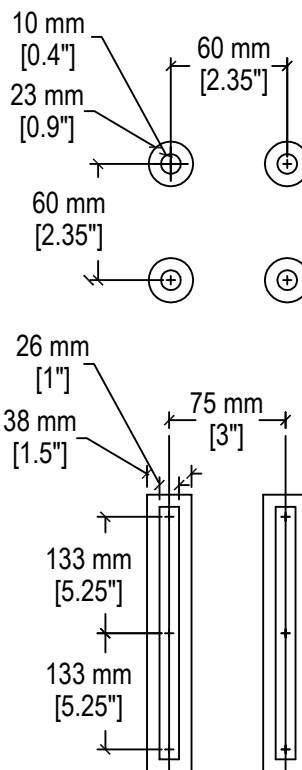

- It is highly recommended that mid-block crosswalks be avoided.
- Curb ramps shall be located or protected to prevent their obstruction by parked vehicles.
- Walkways should be sited on grades that take advantage of natural topography so that excessive grading can be avoided.
- Exterior walkways and ramp flares shall be of a firm, slip resistant material. If concrete, a broom finish perpendicular to the direction of travel shall be provided.
- Asphalt, concrete pavers, unit pavers, well-compacted crushed stone, or lumber with the planks across the direction of travel are permitted in considered site conditions. Exterior walkways shall have adequate 2% positive drainage. Walkways are to be crowned or cross-sloped with gradients not exceeding 2%.
- Highly reflective surfaces on sidewalks can result in glare and are to be avoided.

3.1 Pedestrian Circulation: 3.1.1 Crossings, Intersections, Walkways & Curbs

Complies
Achievable
Does Not Comply



Standard Guidelines for Sidewalks & Intersections

Figure 3.2 – Crosswalks Intersection w/ Traffic Circle	p16 A, B, E, F, G, M
Figure 3.2.A – INSET Crosswalk showing Traffic Island	p16 L, N, O
Figure 3.2.B – INSET Crosswalk Island	p16 L
Figure 3.3 – Curb Ramp Opt. 1	p17 A, B, C, D, F, I, J
Figure 3.4 – Curb Ramp Opt. 2	p17 C, D, F, J, H
Figure 3.5 – Curb Ramp Opt. 3	p17 C, F, I, J, K
Figure 3.6 – Curb Ramp Opt. 4	p17 C, F, I, J, K, P
Figure (3.3 to 3.6)C – INSET Curb Ramp	p17 F

- A** Walkways and sidewalks should be minimum 1500 mm [4' 11"] wide.
- B** Where possible, a walkway gradient shall be 5.0% or built to suit the grade to a maximum of 8.0%.
- C** Turning radii shall be a minimum of 6 m [19' 8"] at any change in alignment; however, in existing construction this radius may vary, and contractors shall check their contract drawings.
- D** Curb ramps shall be provided at all pedestrian crossings, and where perpendicular to a sidewalk, the top of the curb ramp shall be a minimum distance of 920 mm [3'] from the edge of a building. There is to be an adjoining slope surface at the top of the curb ramp not exceeding 8.0%.
- E** The width of the curb ramps, exclusive of flared sides, shall be a minimum of 2 m [6' 6"].
- F** The tactile warning strip edge shall be 152 to 300 mm [6" to 12"] away from the back of the curb.
- G** It is recommended in the CSA standards that curb ramps be reviewed for slope requirements. However, most municipalities adhere to a standard slope of a maximum of 8.0%. The ADA recommends going to the least possible slope on a curb ramp.
- H** Where reasonable and possible, 305 mm [12"] tactile warning strips are to be located at both the top and bottom of the curb ramp. It is better to install brushed concrete (non-slip) next to the raised tactile surfaces than aggregate concrete because the change in texture is easier to detect. However, tactile warning strips created out of aggregate concrete are not as ideal for walking over in wet conditions as the material tends to become slippery under foot. Gravel that is loose is an unstable surface if it is not compacted with angular rock sized approximately 13mm [0.5"] as a maximum. Gravel is not recommended as an alternate material for hazard warning edges.
- I** As a minimum, both the CSA and the ADA require that the colour contrasting tactile warning strip cover the lower 610 mm [24"] of the ramp and not the entire ramp. The truncated domes are to be placed at a setback of 152 to 300 mm [6" to 12"] from roll down curb as space allows.
- J** The truncated domes of the tactile warning strip must be aligned on a square grid in the predominant direction of travel to permit wheels to roll between the domes.
- K** Where directional tactile strips are used and there is a change of direction toward a crosswalk, a tactile hazard warning strip shall be placed at the vertex of the two directional strips to indicate a *stop* and possible change of direction.

Complies
Achievable
Does Not Comply



Standard Guidelines for Sidewalks & Intersections

<i>Figure 3.2 – Crosswalks Intersection w/ Traffic Circle</i>	<i>p16 A, B, E, F, G, M</i>
<i>Figure 3.2.A – INSET Crosswalk showing Traffic Island</i>	<i>p16 L, N, O</i>
<i>Figure 3.2.B – INSET Crosswalk Island</i>	<i>p16 L</i>
<i>Figure 3.3 – Curb Ramp Opt. 1</i>	<i>p17 A, B, C, D, F, I, J</i>
<i>Figure 3.4 – Curb Ramp Opt. 2</i>	<i>p17 C, D, F, J, H</i>
<i>Figure 3.5 – Curb Ramp Opt. 3</i>	<i>p17 C, F, I, J, K</i>
<i>Figure 3.6 – Curb Ramp Opt. 4</i>	<i>p17 C, F, I, J, K, P</i>
<i>Figure (3.3 to 3.6)C – INSET Curb Ramp</i>	<i>p17 F</i>

- L** Accessible pedestrian signals should be installed at all corners of an intersection and they would total eight in number. One accessible pedestrian signal is to be installed on each traffic island. In addition to providing audible and vibrotactile information, Swedish pedestrian signals include a simple tactile map of the pedestrian crossing ahead which for example, tells a person that there is a median and two or three or four lanes of traffic.
- M** Catch basins and manhole covers should be located outside of the walkways and upstream from the intersection. Covers should be flush with adjoining surfaces, and be bicycle proof. Area drains are preferred outside of walkways, but if required to place within, shall have maximum openings of 13 mm [0.5"] perpendicular to the direction of travel.
- N** Traffic islands that form part of the vehicular circulation pattern shall be cut through level with the street or have curb ramps at both sides and a level area 1220 mm [4'] long between the curb ramps in the part of the island intersected by the crossings.
- O** Traffic islands are to have tactile warning strips and directional guides to assist people with visual impairments move across the island, or direct them toward light or signal standards so they are to be able to continue to cross the street safely.
- P** A raised 152mm [6"] curb plus painted concrete wedge between curb ramps is a good solution. The staggered pattern on the warning strip in the wedge contrasts with the even alignment of the truncated domes of the hazard strips at the bottom of the curb ramp. The aligned pattern allows wheels to run between the truncated domes, the staggered pattern deters this.

3.1 Pedestrian Circulation: 3.1.1 Crossings, Intersections, Walkways & Curbs

Figure 3.2 – Crosswalks Intersection with Traffic Circle

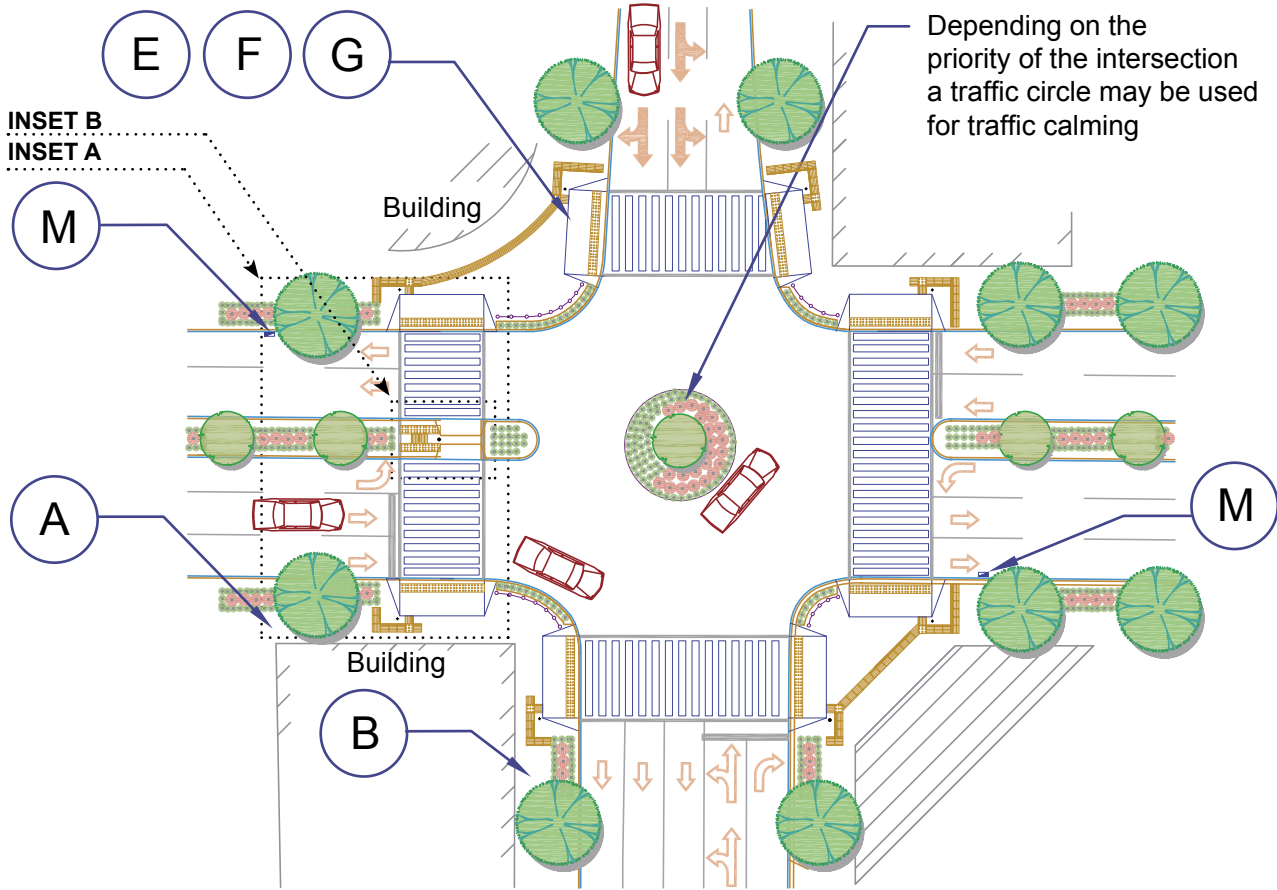

Figure 3.2A – INSET Crosswalk showing Traffic Island

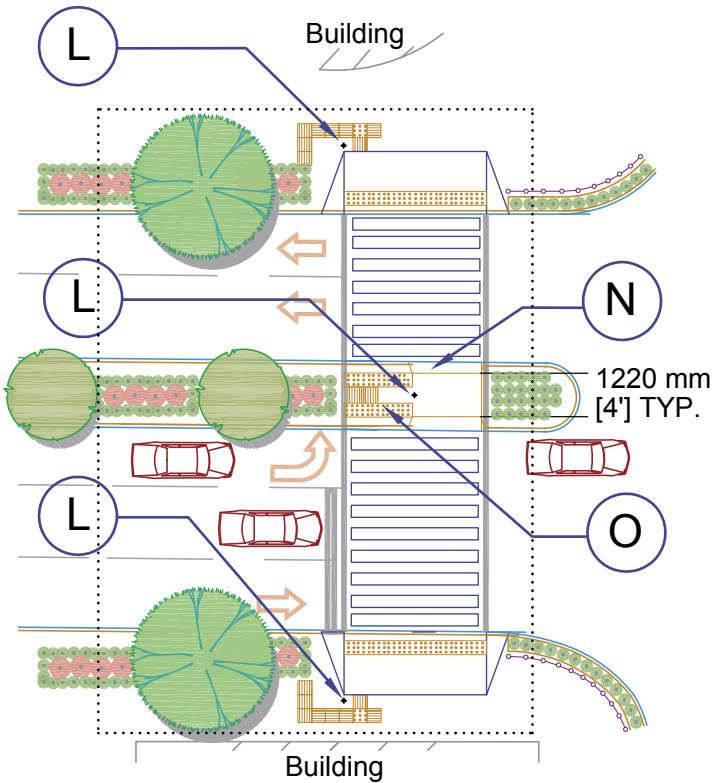
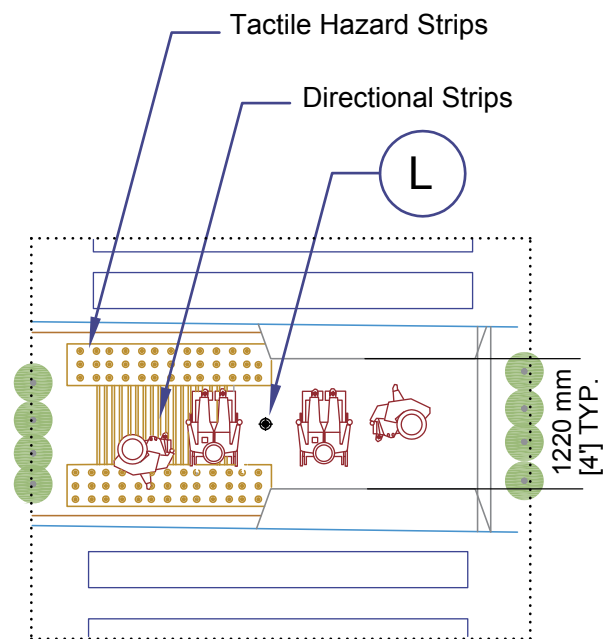

Figure 3.2B – INSET Crosswalk showing Island



3.1 Pedestrian Circulation: 3.1.1 Crossings, Intersections, Walkways & Curbs

Figure 3.3 – Curb Ramp Opt. 1 Single Detectable Warning Indicator

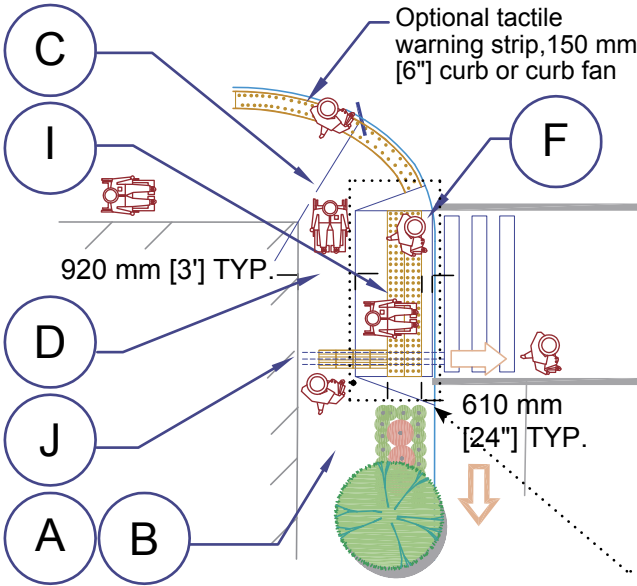

Figure 3.4 – Curb Ramp Opt. 2 Double Detectable Warning Indicator

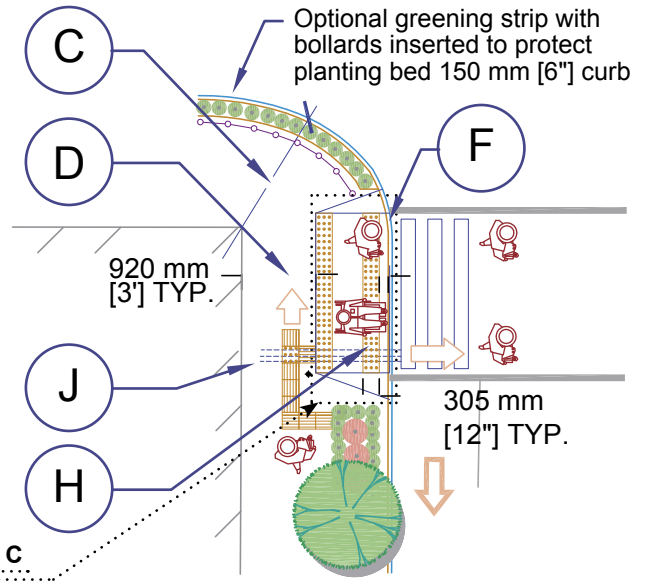

Figure 3.5 – Curb Ramp Opt. 3

Note that CSA considers curb ramps that continue around the corner of a sidewalk to be unsafe for pedestrians

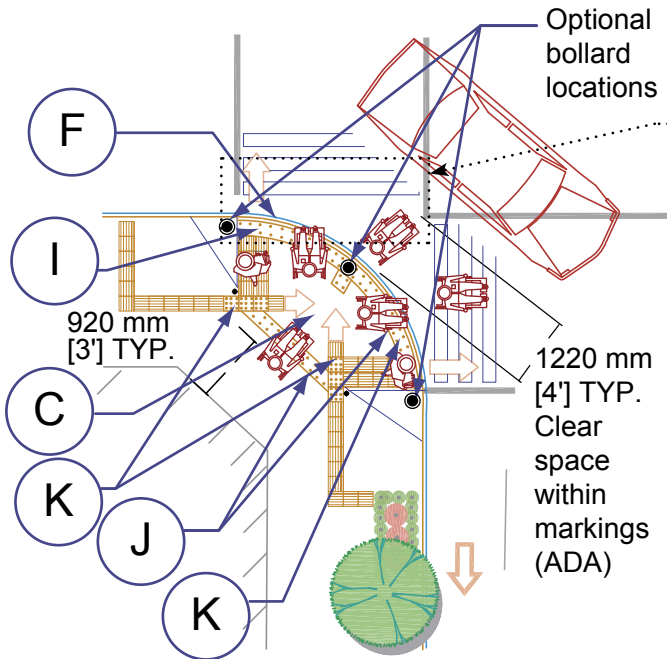

Figure 3.6 – Curb Ramp Opt. 4

Best Universal Design Option Given Site Constraints

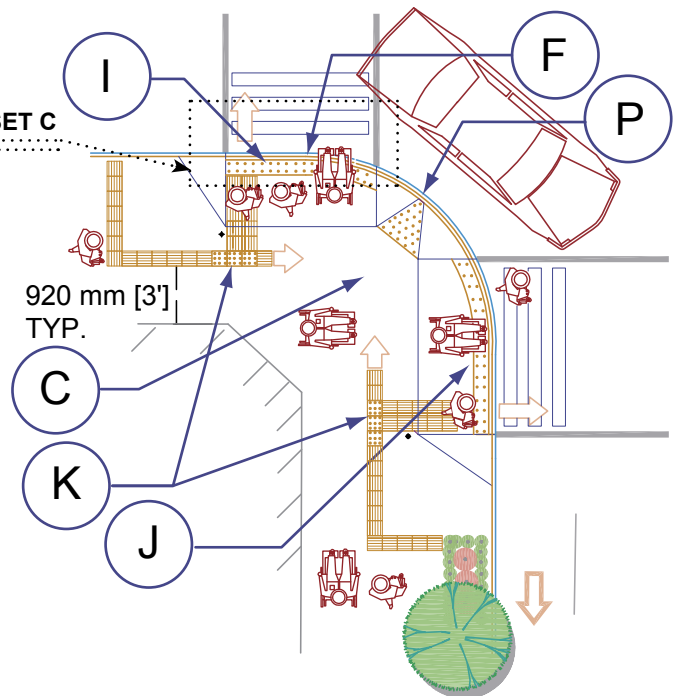
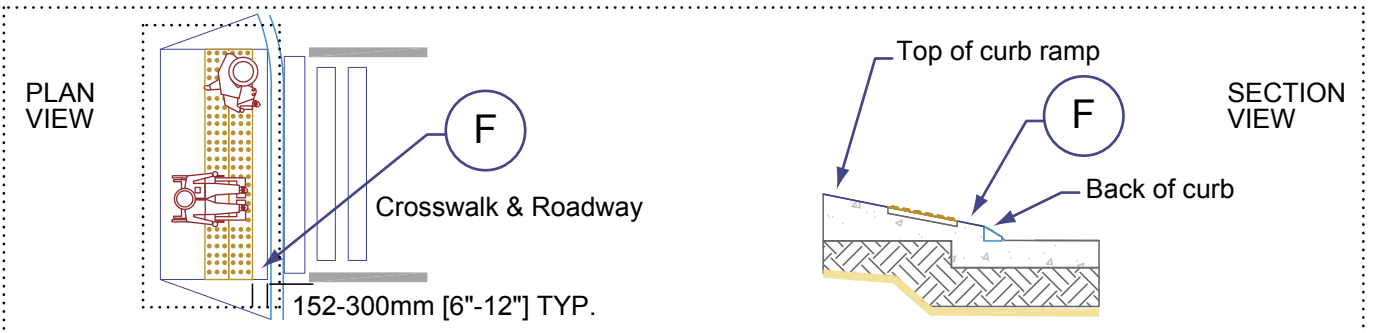
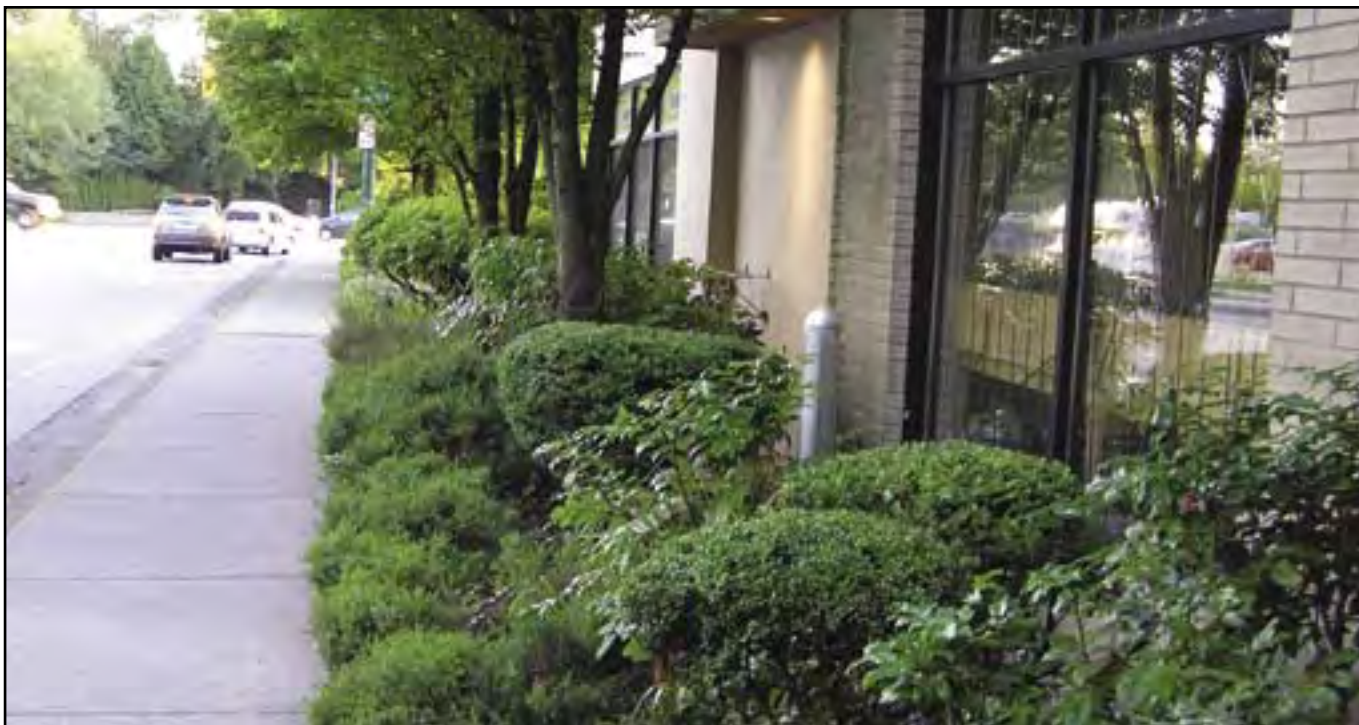

Figure (3.3 to 3.6)C – INSET Curb Ramp



3.1 Pedestrian Circulation: 3.1.1 Crossings, Intersections, Walkways & Curbs

Window Bollard – North Vancouver B.C. / photo credit: Donna Rodman



Overhead and ground level obstructions, protruding objects, and drainage grates within paths of travel, are potential hazards for everyone. Hazardous features can be tripping hazards, trap the wheels of mobility aids, strollers, and bicycles, or be run into by persons with visual impairments. Examples include benches, mailboxes, newspaper boxes, sandwich boards, parking meters, light standards, power poles, protruding window boxes, facade-protecting bollards, tree grates, catch basins, and drainage grates.

The minimum requirement is that 1500 mm [4' 11"] of a sidewalk or walkway is to be clear and free of obstruction. Overhead clearances of 2.3 m [6' 7"] are to apply, even under the underside of a stair system. A power pole in the centre of a sidewalk is particularly difficult to pass for a person using a wheelchair or scooter, as frequently there is little room between the power pole and the private property line or edge of the building. The 1500 mm [4'11"] clearance is a prescribed requirement in such cases and negotiation for placement of the power pole will be required.

To provide these clearances several interventions are possible:

- 1 A protected area with tactile warning strips or guards or a planting bed can be provided either to warn people of the obstruction or hazard or prevent them from running into the object.
- 2 Recessing an object avoids creating a hazard. Setting the mailboxes, sandwich boards, newspaper boxes, garbage receptacles, parking meters, and bollards out of the path of travel or between the trunks of street trees at the outer edge of a sidewalk will help and should be by-lawed and monitored.
- 3 Tree grates and drainage grates are now required to be designed to prevent wheels from dropping into them. For any given area, the criteria should be clear as to the requirements for wheelchair accessibility, snow conditions, and maintenance in the specification of tree grates and drainage grates in sidewalks and walkways. Any grate is to be oriented so that the greater longitudinal space in the grate is positioned perpendicular to direction of travel.

Complies
Achievable
Does Not Comply



Standard Guidelines for Sidewalk Obstructions - Bollards:

Figure 3.7 – Sidewalk Obstructions, Elevation

p19 E

Figure 3.8 – Sidewalk Obstructions, Plan View

p20 A, B, C, D, E, F, G, H, I

- A** Medium HT. Shrubbery HT: 750 mm [2' 5"].
- B** Low Shrubbery HT: 300 mm [12"].
- C** CPTED Bollards HT: 920 mm [3'].
- D** Light Standard.
- E** Tree acts as barrier between Facade and Roadway rather than a Bollard.
- F** Obstruction is recessed from path of travel.
- G** Areas for feature pavement treatment.
- H** Power-assisted door opening button with tactile warning strip.
- I** Wall-mounted power-assisted door opener.

Figure 3.7 – Sidewalk Obstruction Elevation View

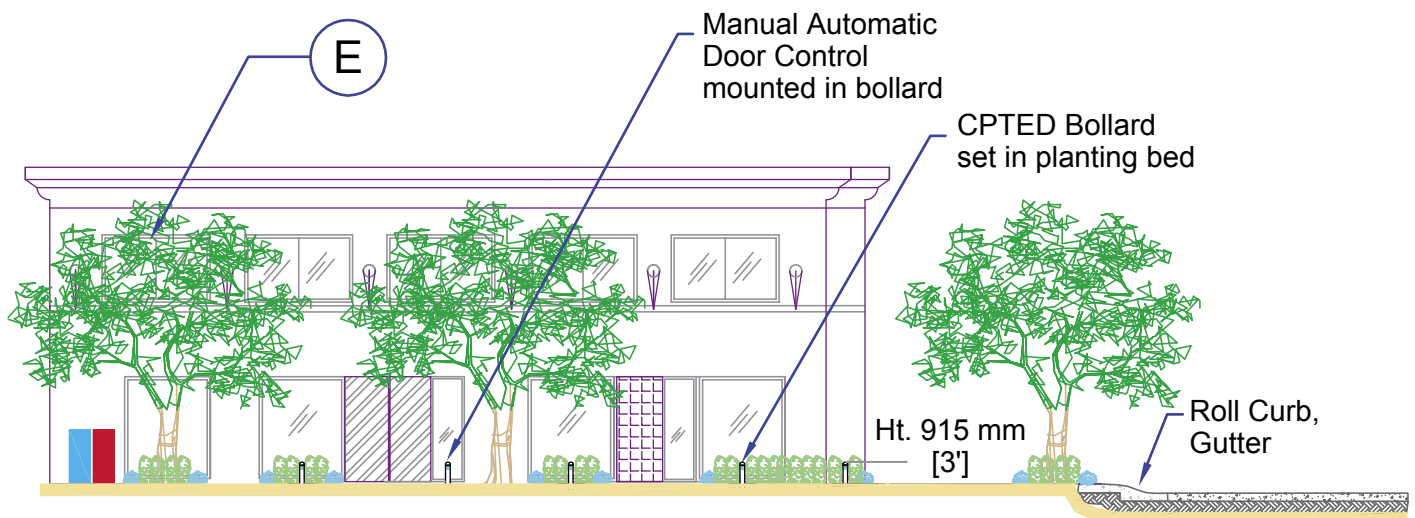

ELEVATION

3.1 Pedestrian Circulation: 3.1.1 Crossings, Intersections, Walkways & Curbs

Figure 3.8 – Sidewalk Obstructions [Plan View]

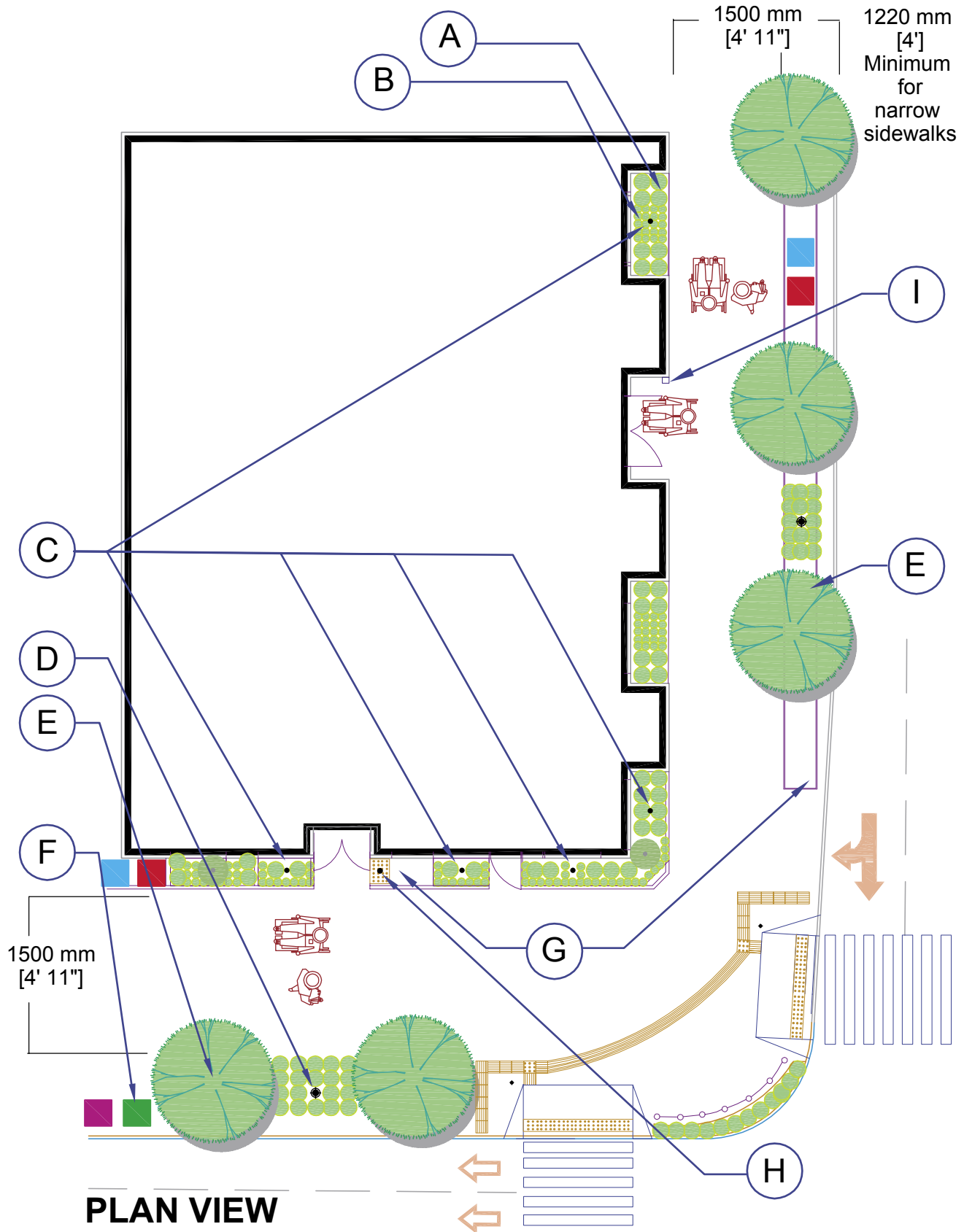

Complies
Achievable
Does Not Comply



Standard Guidelines for Multi-Use Universal Design Pathway or Walkway:

Figure 3.9 – Universal Multi-Use Pathway Crosswalk p22 A, B, C, D, E, F, G, H
Figure 3.9A – INSET Universal Multi-Use Pathway p22 B

- A** Where pathway/walkway widths permit a 4 m [13'] wide pathway, consider using 610 x 610 mm [24" x 24"] directional tactile brick, colour contrasted 70% to surrounding pavement surface.
- B** 610 x 610 mm [24" x 24"] tactile warning brick, colour contrasted 70% to surrounding pavement/surface colour to match directional tactile brick. If the site is constrained or curved, an option to place smaller tactile unit pavers 100 x 200 x 57 mm [4" x 8" x 2.25"] is available. Their size allows placement on a curved edge or in non-linear, squared corners.
- C** 305 mm [12"] depth for the first tactile warning strip on top of curb ramp, truncated domes aligned parallel to direction of travel with 60 mm [2.36"] on centre between truncated domes per detail [Fig. 3.1 p13].
- D** 1200 to 1600 mm [3' 11" to 5' 2"] width clear space, free of irregularities and to be a slip-resistant surface for passage of a person in a wheelchair, a cyclist, or a person with a stroller.
- E** Continuous 200 or 305 mm [8" or 12"] depth for the second tactile warning strip to full length of curb ramp, truncated domes aligned parallel to direction of travel per detail [Fig. 3.1 p13 and 3.9 p22]. Domes are to align with directional tactile strips so that a wheel can travel in a forward direction, without obstruction, between the domes and strips.
- F** 760 mm [2' 6"] wide, brushed concrete or slip-resistant surfacing that is relatively smooth for ambulation and for people using wheelchairs.
- G** Setback of 152 to 300 mm [6" to 12"] from roll down curb as space allows. This space permits a person in a chair to gain traction to travel over truncated domes and gives additional time for a pedestrian to realize the roadway is directly ahead.
- H** Traffic bollards set in tactile warning brick configurations are to be a minimum of 1600 mm [5' 2"] apart for passage of a pedestrian, bicycle, stroller, or person in a wheelchair between bollards.

Figure 3.9 – Universal Multi-Use Pathway Crosswalk

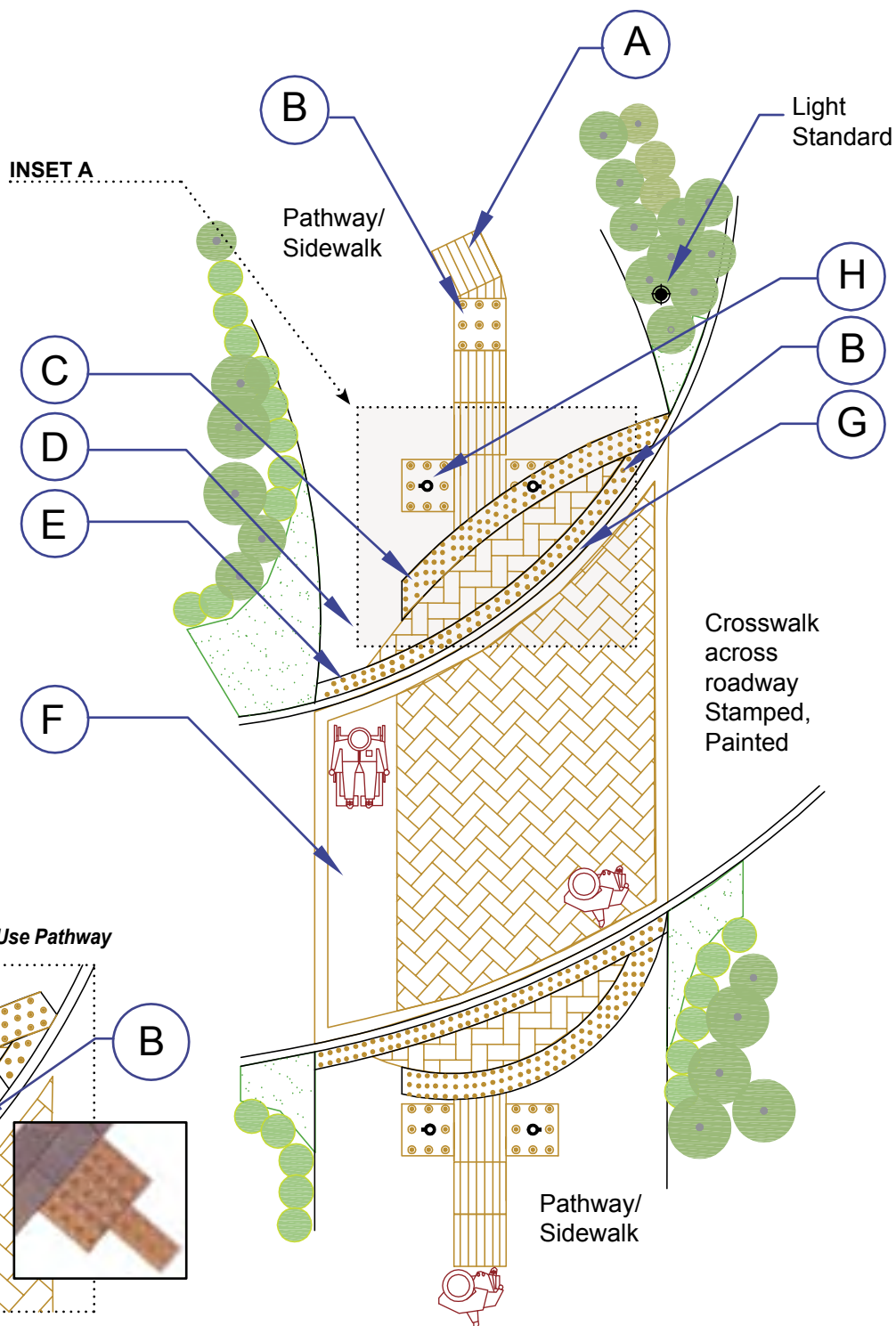
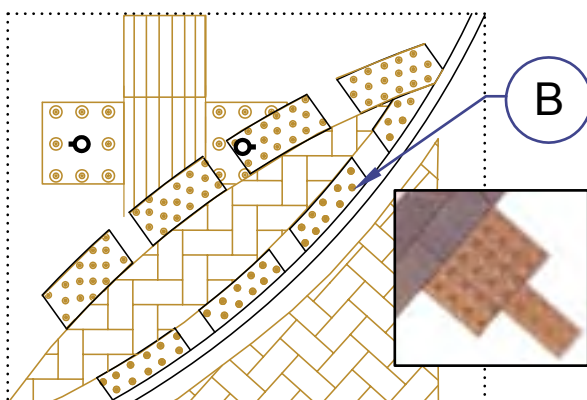

Figure 3.9.A – INSET Universal Multi-Use Pathway



Where the curved edges of curb fans occur, an option is to place smaller tactile unit pavers 100 x 200 x 57 mm [4" x 8" x 2.25"] or space the standard tactile bricks to adjust for the shape of the fan.

3.1 Pedestrian Circulation: 3.1.2 Wayfinding

Wayfinding is a term that describes the spatial problem-solving process that a person uses to reach a destination. Studies in wayfinding and cognition have identified that mental maps are created of the overall setting and the destination one wants to reach. Cues from the environment help to create these maps and the cues not only include signage but spatial forms, structures (especially overhead structures), sounds, surface textures, colours, illumination levels, landmark features, and smells. A well-designed environment can be spatially soothing, exciting, pleasurable, and refreshing, and if simply designed, people can wayfind using varied, non-conflicting cues.

Failing memory and difficulty in orienting are particularly limiting. Orientation may be difficult in areas where a number of directional options or distractors are present. These concerns are compounded when sight and hearing are reduced. Designers attempt to create hierarchies of space to lead people toward a destination and usually a focal point in the landscape acts as the hub from which other spaces radiate.

- Placing a sound mark or a visual mark at two or three corners of an intersection of roads or trails will help a person to recognize the direction they came from, and therefore which direction they want to go in. A roadway intersection is a quadrant like a compass. A person can walk from north to south and remember that a fountain was on their right, followed by a crosswalk and a building corner. If they establish at the third corner that there is a fragrant planter, they can map the corner like a compass. The sequence of perceptible information can be inverted when they walk from south to north and they are oriented to three corners for four directions.
- Nature trail intersections can similarly be marked with waterfalls, fragrant B.C. native plants, and a signage post for trail information that has tactile maps.
- To improve wayfinding in trail design, designers should avoid abrupt changes in direction and complicated trail layouts with numerous optional routes. Where there are abandoned trails, closed trails, or crossings with ski trails, the designer and park planner should consider rehabilitating the trails by planting them with vegetation indigenous to the area and erecting

directional signage or barriers to manage access of such trails.

- Avoid straight, boring trail layouts. This is important because universally designed trails and multi-use accessible trails are quite wide and to some look like a roadway rather than a natural pathway – so variety and gentle changes in alignment are desirable to create interest and adventure.
- In the urban setting there are new signage technologies that include sensors that transmit and receive voice communication with the use of a portable device. This technology allows signs from the front of buses, bus stop signs, and street signs to announce themselves to the person with a visual impairment. They can also be programmed to translate between languages and can be integrated into GPS systems. This permits 3D imaging of maps showing users, for example, subway systems or campus layouts. These advanced systems can only be considered for the purpose of wayfinding if the cost of maintaining the system is provided for. The longevity of technology systems is important due to the consequences for people with disabilities who rely on the systems and are suddenly found without them. This can result in unsafe navigation and accidents as their means of communication and wayfinding breaks down.

Figure 3.10 – Wayfinding Model

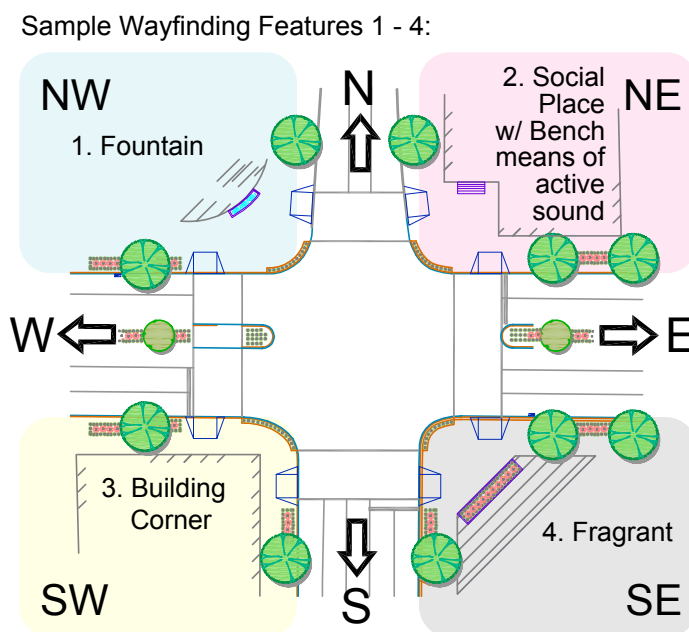

3.1 Pedestrian Circulation: 3.1.3 Seating & Gathering Areas / Rest Areas

Accessible Social Seating Area – Maple Ridge, B.C. / photo credit: Donna Rodman



- Spatial structure, organization and design features should incorporate seating and gathering areas that accommodate everyone. Outdoor seating areas include bleachers at play fields, and seating at amphitheatres and outdoor classrooms.
- Consideration to sun orientation and prevailing winds will increase the use and comfort level of seating areas. Providing shade over public seating areas is recommended whether created by trees or awnings.
- Slip-resistant surfaces shall be used (i.e. brushed concrete, unit pavers, asphalt, compacted granite screenings, and fines). Gradients shall not exceed 2%.
- Facilities and site furnishings shall not interfere with pedestrian circulation.
- Trash receptacles and drinking fountains should be accessible (*refer to section 3.4.7 Trash Receptacles & Recycling Bins*).
- Adjacent to seating locations an additional 915 mm [3'] width shall be included to accommodate people in wheelchairs so that they may sit beside their friends and family. This shall be positioned so as not to interfere with pedestrian circulation.

Seating – Variety Park Playground, Central Park, Burnaby, B.C. photo credit: Donna Rodman



- Covers and grates shall be flush with adjoining surfaces and have no openings larger than 13 mm [0.5"].
- Rest areas shall be located at least every 100 m [328'] along pathways. If possible, a seating bench with a backrest and side arms should be located along pathways and recessed back from the pathway so that a pedestrian may walk past the bench without obstruction. A 915 mm [3'] wide seating open space adjacent to the bench is necessary so that a person in a chair may converse with a companion on the bench. The surfacing of the adjacent seat area should be concrete, asphalt, or compacted granite and granite fines.

RAMPS

There is a distinction between the space requirements and human factor dynamics of people who are using wheelchairs and people who are using powered mobility chairs. Codes, standards, and guidelines do not currently address the dimensional requirements of scooters and powered wheelchairs. Since there has been a significant growth in population of users with scooters and powered chairs, serious consideration must be made by planners and designers to increase many common amenity spaces in the built and outdoor environment. There is a need to increase dimensions with regard to 360 degree turns; the width of paths of travel; ramp landings; and landings in front of doors. Anthropometric reach requirements and wheel base turning diameters, have also changed such that specific dimensional increases and decreases are required for ramps and their landings. A good reference to look at is the booklet entitled *Determination of New Dimensions for Universal Design Codes and Standards with Consideration of Powered Wheelchair and Scooter Users* (Ringaert, 2001).

- Changes in elevation cannot be avoided, but in all cases, ramps shall be provided either as the only way into a building or in conjunction with stair systems. Ramps are site specific. To follow the principles of Universal Design, ramps shall be integrated into the overall facility design. If stairs can be avoided through grading and a pedestrian walkway at between 2 and 5% as the singular entry, ramps and stairs are not necessary.
- Ramp layouts may be straight, angled, or switchback with intermediate landings.
- Tactile warning and directional guide strips are recommended to be positioned prior to the landing area of a ramp when there is transitioning or changing of direction from a walkway onto a ramp landing leading to a new elevation.
- Tactile warning and directional guide strips are to be placed at the bottom of a ramp to direct the user onto the connecting walkway.
- Ramp slopes and widths are to conform to the requirements of the BCBC or CSA standards. The CSA requires a 920 mm [3'] wide ramp for one person in a chair and 1200 mm [3' 11"] width for one person in a chair and one pedestrian

Ramp and Stairs – Maple Ridge ACT Theatre, Maple Ridge, B.C. / photo credit: Natasha MacArthur



3.1 Pedestrian Circulation: 3.1.4 Ramps, Stairs & Stramps

walking beside. Recommendations of a recent study conducted, included a human factors analysis that has increased the dimensions:

Type	Recommended above CSA Minimum
One Chair	Increase from 920 to 984 mm [3' to 3' 3"]
Two Chairs	Increase from 1500 to 1882 mm [4' 11" to 6']
One Chair/One Pedestrian	Increase from 1200 to 1596 mm [4' to 5' 3"]

[Determination of New Dimensions for Universal Design Codes and Standards with Consideration of Powered Wheelchair and Scooter Users, 2001, p.60]

- Results of studies that compared the turns on landings of ramps by users of wheelchairs, scooters and powered wheelchairs, recommended:

Type of Turn	95% of Users are Accommodated
180 degree turns	1650 mm [5' 5"] depth x 2640 mm [8' 8"] width
90 degree turns	1525 mm [5'] depth x 1525 mm [5'] width

With a switchback in a ramp, the landing transition between one ramp to the next should be 1650 mm [5' 5"] in depth by 2640 mm [8' 8"]. People driving scooters and moving from one ramp elevation to the next ramp elevation require either an increase in width or an increase in depth in order to turn within such a landing between ramps.

- Handrails, guards, and curbs are recommended to conform at a minimum to the BCBC or CSA standards.
- Glare and shadows on ramps shall be avoided as this affects depth perception and a person's assessment of slope and judgment on degree of effort to mount the ramp. Ramp surfaces shall be illuminated to a minimum average of 50 lux at building entrances and 20 lux elsewhere.
- Erosion at the end of a ramp edge is often the case in the natural environment. Frequent maintenance is needed to insure that surfacing does not come away from the end of ramp, creating a break and bump in the transition space to a walkway or natural pathway. Alternatively, an asphalt apron would create a seamless transition between the end of ramp and the beginning of a pathway and to resolve erosion issues. Ramps should terminate in areas free of water build-up at both top and bottom.

- Where reasonable, a cover or sub-surface heating system should be considered to keep ramps free of snow, ice and freezing rain for winterized facilities and buildings. Another option is to use a porous metallic material on the ramp surface to lessen snow or ice buildup. Maintenance is needed.
- Providing slip-resistant surfaces on outdoor wooden ramps is considered to be a necessity and poured-in-place ramps are to be brush surfaced to create slip resistant textures on the ramp surface.

STAIRS

- Stairs together with integrated ramps should be provided where a change in elevation is unavoidable. Studies in gait analysis have revealed that most people find steps easier to walk up than a ramp. An example is a person who has sustained a stroke where the dragging of a toe and foot occurs while ambulating. If the gait is deliberate and the knee of the affected side is efficiently raised, then walking up stairs is easier than walking a ramp where the body has to compensate for a shift in the centre of gravity and a tilting of hips to move up a sloped flat surface. The type of stair also dictates the extent of the safety of climbing as open riser steps, often found in outdoor amenity decks, cause problems with toes catching under the nosing of the tread resulting in tripping accidents. Giving a person the choice of climbing a stair or walking up a ramp is very important as it allows a person to decide, within their abilities, which feature they can use to move from one level to another.

*Stair System – Heritage Woods, Port Moody, B.C.
photo credit: Donna Rodman*



3.1 Pedestrian Circulation: 3.1.4 Ramps, Stairs & Stramps

- A minimum width of 1500 mm [4' 11"] should be provided to accommodate 2-way traffic.
- Open risers shall be avoided if possible, and should not be used in or around buildings.
- Stairs shall have anti-slip strips on all nosings. Nosings should be rounded or chamfered and should not project more than 38 mm [1.5"]. Shadow strips for colour contrast along the base of stairs shall not be more than 20 mm [0.75"].
- To aid people with visual impairments, the nosings on stair treads may be painted with contrasted colours such as white, yellow or blue. The paint also can have a rough texture. Again the contrast value should be at least 70% with the surrounding surface per the ADA, and in the case of yellow paint, the contrast value should be at least 40% per the CSA recommendations.
- Stairs should consist of a short direct run. Consistency and predictability in the stair system configuration is very helpful and reduces the opportunities for missteps and tripping. A minimum of three risers is required with a maximum vertical difference, as stipulated in the BCBC, between landings in a single run. A flight of stairs shall have uniform riser heights and tread depths pursuant to the BCBC standard.
- Treads should be sloped forward a maximum of 1% to 2% prevent accumulation of water.
- People with visual impairments rely on handrails to guide them on stairways. A continuous handrail assists with negotiating changes in direction on a stair system. Stairs shall have continuous, graspable handrails on both sides, and an intermediate handrail if wider than 2200 mm [7' 3"] per the BCBC. Such intermediate handrails are to be continuous between landings and they are to be located such that there will not be more than 1650 mm [5' 5"] between handrails.
- To assist persons with visual impairments, a 1100 mm [3' 7"] long landing is recommended to be provided at the top and bottom of each flight of stairs. Surfacing tactile warning strips conforming to BCBC minimum standards are to be provided for the full width of the stair. The tactile strips are to be set back from the stair

nosings by the depth of one tread and be 725 to 775 mm [2' 7"] in width. To further increase the width of the warning strip to between 900 mm [2' 11"] and 920 mm [3'], the designer would be conforming to the CSA standards. In both cases, the raised tactile strips are to be perpendicular to the direction of travel. If directional guiding strips are called for to direct a person to the stair system, then directional guide strips of 700 mm [2' 4"] width are to lead to the tactile warning strip.

- Overhead hazards less than 2030 mm [6' 7"] off the floor, require a guardrail or other barrier such as bench, to prevent a pedestrian from banging their head on the underside surface overhead. The guard rail shall provide its leading edge at or below 680 mm [2' 2"] from the floor to warn a pedestrian of the overhead hazard.

STRAMPS

- While creating a stramp, a combination of ramp and stair, is often a solution reached for by designers when site constraints are restrictive, it is not a recommended solution due to the potential of inadvertently creating tripping hazards and missteps by pedestrians ambulating across the surfaces of the ramp and stairs.

Stramps – Vancouver, B.C. / photo credit: Donna Rodman



3.1 Pedestrian Circulation: 3.1.5 Handrails

Figure 3.11 – **Wooden Handrail**
[Section View]

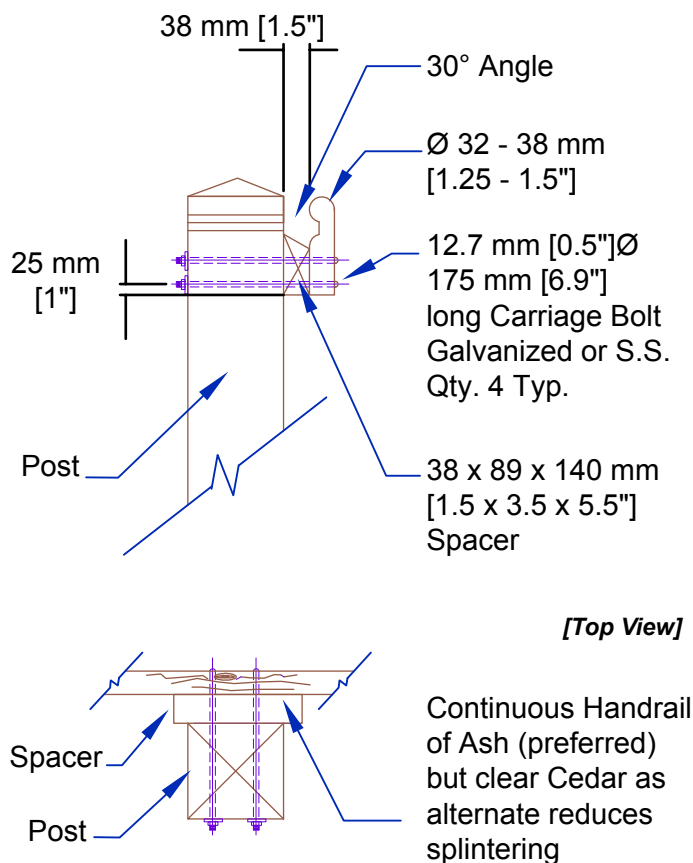
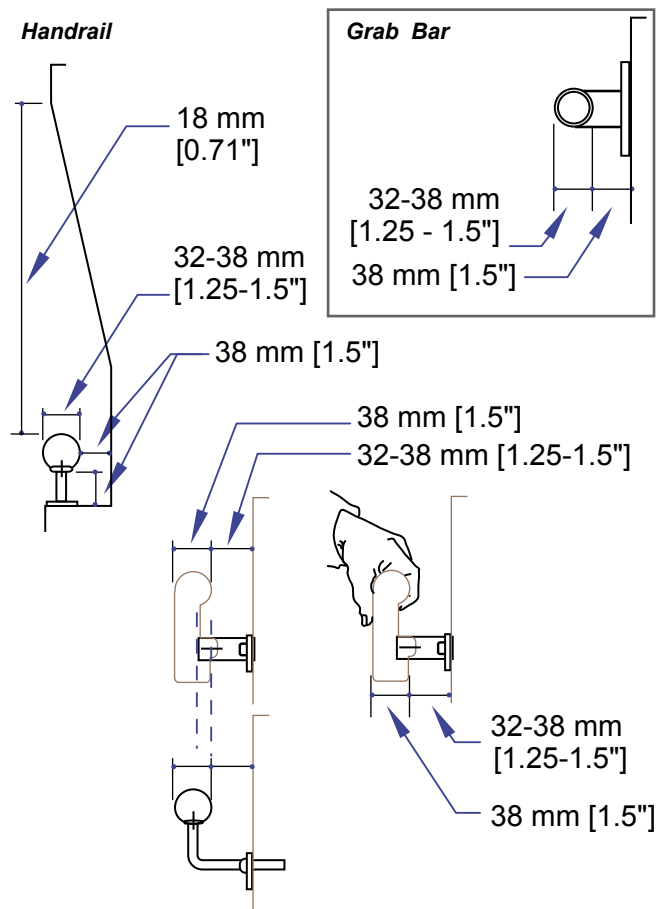

Figure 3.12 – **Handrails and Grab Bar**
[Section View]



- Handrails shall be provided on both sides of stairs and ramps.
- Handrails shall be terminated in a manner which will not obstruct pedestrian travel or create a hazard. For designers, this means incorporating a 300 mm [12"] handrail horizontal extension beyond the top and bottom of the stairway or ramp and such an extension is to be recessed from the pedestrian travel pathway.
- Handrails are to be designed as continuous and graspable with a cross-section diameter of not less than 30 mm [1.25"] and not more than 50 mm [2"]. A clearance of not less than 40 mm [1.5"] shall be provided between a handrail and any wall to which it is fastened. This is to prevent abrasions and provide adequate space for gloves.

- A 300 mm [12"] horizontal extension of the handrail at both the top and bottom of the stairs or ramp means that designers need to consider positioning the extension and its termination in a manner which will not obstruct pedestrian travel or create a hazard.
- An option is to provide handrails at two heights. The BCBC calls for heights of not less than 865 mm [2'10"] nor more than 965 mm [3' 2"], measured vertically from the stair nosing or surface of the ramp or stair landing. These heights are required. Intermediate handrails at lower heights are permitted to accommodate children for both stairs and ramps.
- Handrail materials shall be splinter and rust proof. It is recommended that hemlock and spruce species be avoided for use as wood handrails. Use painted steel, stainless steel, or brushed aluminum for metal handrails. Metal handrails are much easier to adapt to uneven shapes, bends, and turns.

3.2 Vehicular Circulation

3.2.1	Parking Areas	30
3.2.2	Accessible Parking Lot / Stalls	31
3.2.3	Bus Stops	32

 Standard Guidelines for Bus Stops: - p33	<i>Figure 3.13 – Bus Stops</i>	34
---	--------------------------------	----

3.2.4	Drop-Off & Pick-Up Areas	35
-------	--------------------------	----

 Standard Guidelines for Drop-Off & Pick-Up Areas: - p36	<i>Figure 3.14 – Drop-Off & Pick-Up Areas</i>	36
--	---	----

3.2

Vehicular Circulation

3.2 Vehicular Circulation: 3.2.1 Parking Areas (Above, Underground & Trailhead Parking)

Universal Parking – Fenway Park, Boston, Massachusetts / photo credit; Donna Rodman



- The overall layout of the roadways around parking areas, particularly in natural settings, must respect the natural systems of the site.
- Circulation routes adjacent to designated parking spaces are to be part of the shortest accessible route to the building or facility entrance that is accessible no matter if the parking area is outdoors or underground.
- The design of the designated parking areas shall not necessitate backing up from a space into a street, primary circulation route, or entrance.
- A driveway solely used for parking lot ingress/egress is not considered a primary circulation route.
- The design of the pedestrian system, as it relates to the vehicular circulation, is integral to the overall circulation to achieve safety so that people sitting low in wheelchairs or scooters are not travelling on roadways behind vehicles that may be backing out. Pedestrian connectivity allows the user to see their designation once they are out of their vehicle, the surfacing and slope of the access route is accessible and walkable, and safe access across marked crosswalks to walkways is achieved. Pedestrian routes typically follow the roadway pattern where walkways are adjacent to the roadway or parking area.
- Because close proximity parking is difficult to achieve in outdoor facilities such as fairgrounds, community sports fields, or natural parks where parking is separated from trailhead locations, Universal Design approaches this issue by falling back to basic design considerations. Parking areas that are to be designated for exclusive use by drivers, using mobility aids are to be provided near the park entrance/exit and major facilities of the park. Refer to Section 3.4.13 Walkways and Pathways regarding the connecting of parking areas to accessible walkways and pathways.
- When planning the park facilities, the park entrance/exit is to be located in the vicinity of the nearest train station or bus stop.
- Parking areas shall provide drop curbs and appropriate pavement and pavement markings.
- Grades shall be as gentle as possible, while maintaining adequate drainage to prevent water and ice accumulation.
- Where concrete car wheelstops are used in parking lots, a distance of 800 mm [2' 7"] spacing between wheelstops is required. This permits a person with a mobility aid to travel between the car wheelstops to access curb ramps onto pedestrian sidewalks and crosswalks in parking lots.
- Within outdoor parking lots, separate bus and R.V. parking should be provided as required. Minimum stall width 4000 x 4572 mm [13' x 15'].
- Within underground parking lots, there should be consideration for the height of high top vans, which people with disabilities often use. This is an area for the architect and structural engineer to ponder with respect to higher clearances.

3.2 Vehicular Circulation: 3.2.2 Accessible Parking Lot / Stalls

- Provide a direct and clear barrier free route from roadways and parking lots to building entrances and park facilities.
- The number of stalls provided in underground parkades is dictated by the BCBC in accordance with occupancy and building classification criteria.
- The distribution and number of stalls in open natural spaces is based on perceived demand. However, all major building and park facilities providing parking should have a minimum of two accessible stalls located by accessible walkways.
- Designated spaces shall be identified by a vertically mounted sign and the International Symbol of Access painted on the pavement or hard surfacing. Of course, where painting of the pavement is not reasonable, the vertically mounted sign will have to do. Where the location of the designated parking spaces is not obvious, as in a natural park, directional signs should be in place along the route to lead drivers to the accessible parking areas.
- Vertical signs should be officially recognized by the local jurisdiction as the International Symbol of Access or be the sign from the *Transportation Association of Canada's Manual of Uniform Traffic Control Devices for Canada*. [Ottawa: Transportation Association of Canada, 1998]. The signs should be placed not in the centre of the designated parking space, but to the side so that they may be seen from a driver's seat. The CSA standard calls for them to be at least 300 mm wide x 450 mm high [11" x 17"], having the centre of the sign 1500 to 2500 mm [4'11" to 8' 2"] from the ground.
- All accessible parking spaces should be hard surfaced – asphalt, concrete, unit paver, or compacted screenings. The surfacing should be level, stable, firm, and slip-resistant, and where possible, diagonal markings should show the access aisle.

*Parking Lot with Wheelchair Accessibility - Maple Ridge, B.C.
photo credit: Natasha MacArthur*



- Universal parking space design is quite reasonable and doable. Basically, all accessible spaces are 3350 mm [11'] wide with a 1525 mm [5'] access aisle. The advantage is that no additional signage is needed to indicate car and van spaces because all spaces can accommodate either a car or a van with a side-mounted lift or ramp. The wider space permits vehicles to park to one side or the other within the 3350 mm [11'] space to allow persons to exit and enter the vehicle on either the driver or passenger side. [ADA]
- The access aisle must be at the same level as the parking space and cannot be raised, ramped or sloped due to the nature of the side lifts typically part of the van vehicle. The parking access aisle must either blend with the accessible route or have a curb ramp within the access aisle boundary to the accessible route. The curb ramp cannot be within the parking space boundaries as it will be blocked when a vehicle parks in the stall. The required dimensions of the access aisle cannot be constrained by planters, curbs, or wheel stops.
- The CSA standards provide examples of car parking spaces with access aisles on the diagonal and parallel to sidewalks.
- In parking lots, wheelstops, bollards, or curbs serve to prevent parked vehicles from protruding into the accessible circulation route.

3.2 Vehicular Circulation: 3.2.3 Bus Stops (In accordance with Coast Mountain Bus Company standards)

- In the Lower Mainland, we have one major transit operator and several local bus companies. BC Transit does have its own accessibility guidelines. However, at the local and regional level outside of the Lower Mainland, communities can research their local bus service provider for accessibility guide lines.
- It is recommended that transit service on hilly terrains provide buses with mechanical loading systems such as lifts to compensate for level changes that cannot be eliminated due to slope of bus and slope of street or walkway surface.
- The design objective is to reduce the change in level between vehicle floor and loading surface to a minimum or eliminate entirely with low floor *kneeling* buses or stairless buses.
- Avoid indentation for a catch basin at the loading area of a bus stop.

Accessible Bus Sign - Maple Ridge, B.C.
photo credit: Natasha MacArthur



Bus Shelter - Maple Ridge, B.C.
photo credit: Natasha MacArthur



It is recommended that when applying the guidelines below, a copy of the recent accessibility design guidelines published by the Bus Transit Authority be used for greater detail. These guidelines are not fixed and prescriptive but serve as general design guidelines to be interpreted within the existing infrastructure that BC Transit is addressing in accessibility. Rural bus stops do pose challenges and are not completely addressed.

Documents to reference: "BUS STOP" BC Transit Municipal Systems Program: Design Guidelines for Accessible Bus Stops and Document B651-04 CSA Accessible Design for Built Environment Section 4.6.2.2.

Crime Prevention through Environmental Design (CPTED) principles are not part of this publication and local examples of community derived documents are available.

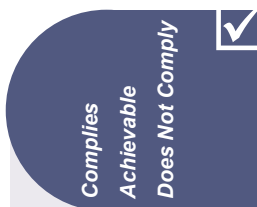

Standard Guidelines for Bus Stops:

Figure 3.13 – Bus Stops

p34 A, B, C, D, E, F, G, H, I, J, K

- A** The bus stop waiting pad should be clear 2.1 m [6' 10"] to allow buses with ramps to unfold the ramp to rest onto the pad surface so there is no gap between the edge of the ramp and the pad surface.
- B** Provide an accessible connection minimum of 1.5 m [5'] wide between an adjacent sidewalk and the bus stop waiting pad.
- C** Benches, garbage receptacles, bike racks, and newspaper boxes, must be kept 1.5 m [5'] clear of the bus loading area to allow for bus loading and unloading.
- D** Any bus stop signage or overhead elements such as a bus shelter, require a 2 m [6' 6"] clear headroom. The bus stop signage is to be accessible and 'Talking Signs' technology should be considered.
- E** A tactile warning pad 1 x 1m [3' 3" x 3' 3"] is to be provided offset from the clear area provided for the bus ramp in order that people with visual impairments may wait at the spot where the bus doors would open. In addition, directional tactile brick should be installed directing the person with a visual impairment into the Bus Stop waiting area. Domes are to align with directional tactile strips so that a wheel can travel between the domes and strips in a forward direction without obstruction. (*Refer to Section 3.1.1 Crossings, Intersections, Walkways & Curbs for information on tactile strips.*) In rural areas or roaded natural areas, it is recommended that some form of tactile treatment be applied at public stops. Compacted gravel, crush stone with cement binders, or an asphalt pad with contrasting colour imbedded as a thermo treatment would indicate the accessibility of the bus stop. The bus stop route needs to be part of an accessible bus system for this to work.
- F** The space between the corner of the tactile warning pad (for waiting) and the corner of the recessed area for the bench, should have a width of 915 mm [3'] to allow ambulation and people using chairs to enter the bus waiting area without having to cross over the tactile warning pad to do so.
- G** The tactile warning strip is to have a width of 600 to 900 mm [2' to 2' 11"] and be of length of 8.5 m [27' 10"] in rural/urban settings. The offset from the drop-down or roll-down curb is 152 to 300 mm [6" to 12"]. In roaded natural settings, it is recommended a public stop have compacted gravel or crushed stone with cement binder or compacted screenings.

Complies
Achievable
Does Not Comply

Standard Guidelines for Bus Stops:

Figure 3.13 – Bus Stops

p34

A, B, C, D, E, F, G, H, I, J, K

- H** All seating should be designed to accommodate 115 kg [250 pounds] per person. Arm and back rests on a bench make it easier for seniors to push themselves up off the bench. The concrete pad to which the bench is fixed should be level and constructed on a firm ground surface that won't heave. The bench is to be offset 1.5 m [4' 11"] from the tactile warning strip keeping the wait platform clear. The rest area for a person in a wheelchair requires additional recessed room so the chair's footrests do not stick out in the pedestrian area. The area is to be 915 mm x 1200 mm [3' x 3' 11"], recessed, and beside the bench and on firm, non-slip surfacing.
 - I** Pedestrian scale lighting is recommended for security and wayfinding purposes.
 - J** If a shelter is not built at the bus stop, then trees are recommended to provide shelter from wind, rain, and sun. In urban and rural settings, care is required to ensure that regular pruning and picking up of wet leaves occurs to maintain all public stops.
- Trees located near the area are to be monitored for roots heaving the waiting pads and sidewalks. Fully-leaved branches blocking the pedestrian scale lighting shall be pruned by an arborist to allow proper walkway lighting at night.
- K** The shrubbery planted around the sitting bench and waiting areas of bus stops should be a combination of ground covers and low lying shrubs to a maximum height of 600 mm [24"] for security and visibility reasons. (CPTED)

Figure 3.13 – Bus Stops

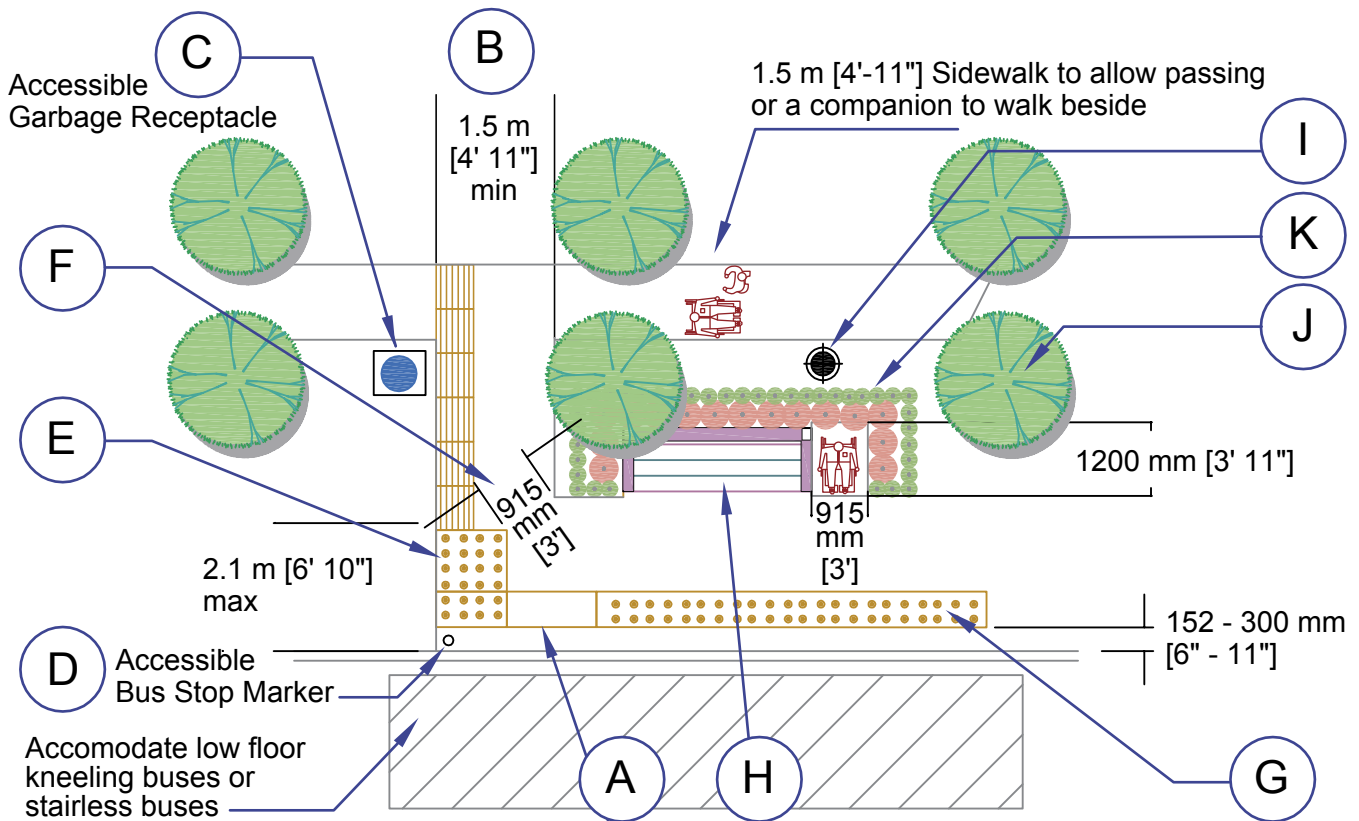

3.2 Vehicular Circulation: 3.2.4 Drop-Off & Pick-Up Areas

- A passenger pick-up area is the same as a drop-off area and should be provided where accessible parking cannot be located close to building entrances or park facilities.
- The drop-off and pick-up area should not interfere with other vehicular flow. Drop-offs, turnarounds, service drives, and driveways through ingress/egress are considered to be primary circulation routes. Separating the drop-off areas from the main circulation route is recommended as the safest manner to allow people using mobility devices to unload, transfer, and safely move toward an accessible route and walkway.
- Passenger car drop-off/pick-up areas shall be 4.5 m [14' 10"] wide x 10 m [32' 10"] long with appropriate curb radii for easy ingress/egress.
- On the passenger side of the car, and between the curb and the vehicle, an access aisle is recommended to be provided that is parallel and adjacent to the pedestrian walkway as passengers using mobility aids require a transfer space level with the roadway. The curb is to contain a curb ramp at one end to access the accessible route. If there is no curb, a tactile warning strip should outline the drop-off/pick-up area.
- Drop-off/pick-up areas require a shaded or covered seating area with waiting pad beside.
- In underground parking areas, a height clearance of at least 2.75 m [9'] shall be provided at passenger drop-off/pick-up areas to accommodate tall van lifts as a person in a wheelchair is lowered to the ground surface.

Accessible Parking, Building Entries and Drop-Off/Pick-Up Areas
Planet Ice and Golden Ears Winter Club, Maple Ridge, B.C. / photo credit: Donna Rodman



Complies
Achievable
Does Not Comply

Standard Guidelines for Drop-Off & Pick-Up Areas:

Figure 3.14 – Drop-Off & Pick-Up Areas

p36

A,B,C,D

- A** Curb ramps for drop-off areas should conform to Universal Design principles and criteria contained within this publication.
- B** The specifying of modified lighting standards for open spaces wherein a person may plug into the base of the light standard to recharge powered chair batteries may be considered. (Refer to Section 3.4.8 Site Lighting for further information.)
- C** Under Section 3.4 Park Services, trail signage has been presented with respect to the type of information to be provided to multiple users of an outdoor amenity space. Trail signage is to be set off the path of travel providing an area to maneuver in front of and read the trail kiosk information boards.
- D** Drop-off/pick-up areas require a shaded and/or covered seating area for waiting.

Figure 3.14 – Drop-Off & Pick-Up Areas

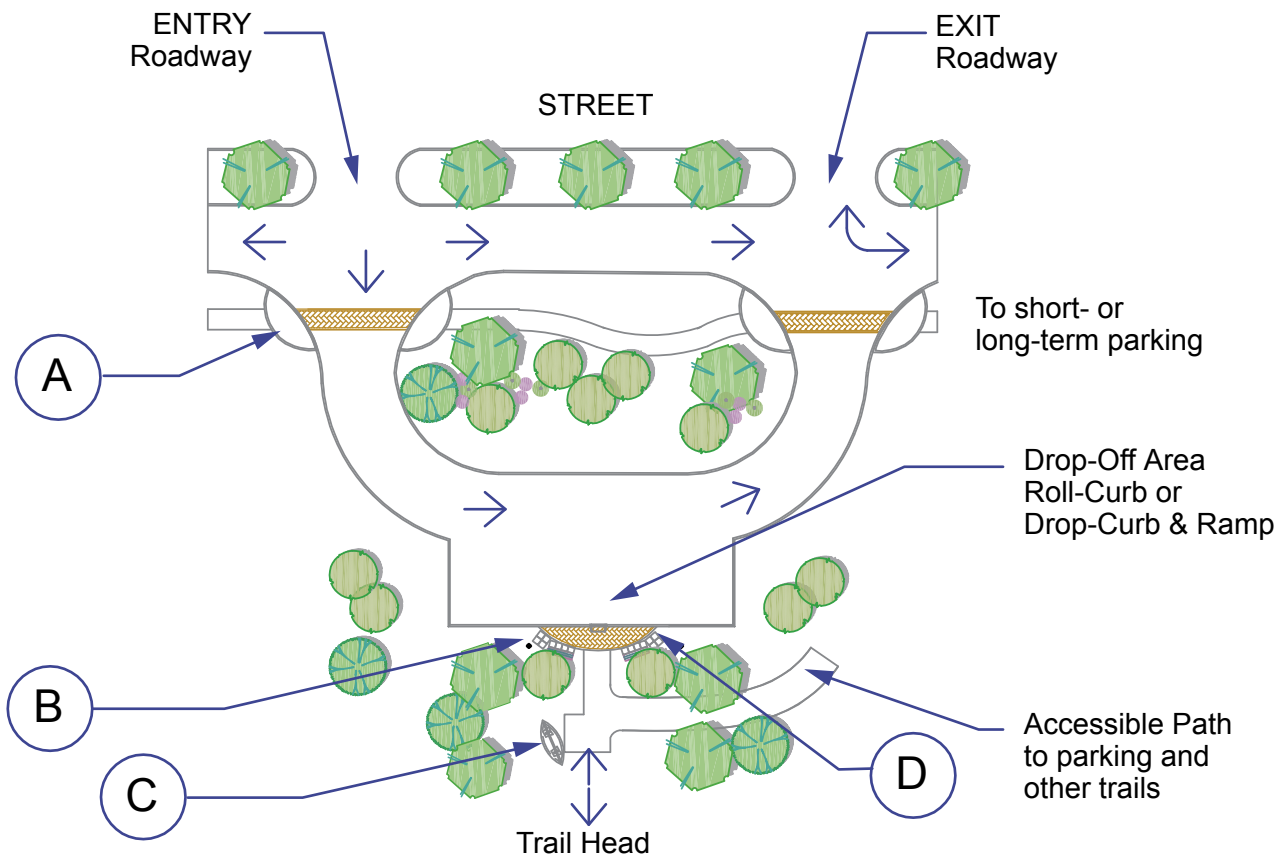

3.3 Recreation Facilities & Outdoor Spaces

3.3.1	Public Building Entries & Arrival Areas	38
3.3.2	Doors, Door Handles & Thresholds	39
3.3.3	Children's Play Areas	40
3.3.4	Water Parks	42
3.3.5	Outdoor Amphitheatres	43
3.3.6	Registration & Condiment Counters	43
3.3.7	Sailing Facilities & Boat Launches	44
	<i>Figure 3.15 – Canoeing and Kayaking Jetty</i>	45
3.3.8	Horseback Riding Facilities	46

✓ Standard Guidelines for Equestrian Platforms: - p47

Figure 3.16 – Equestrian Mounting Platform

47

3.3

Recreation Facilities & Outdoor Spaces

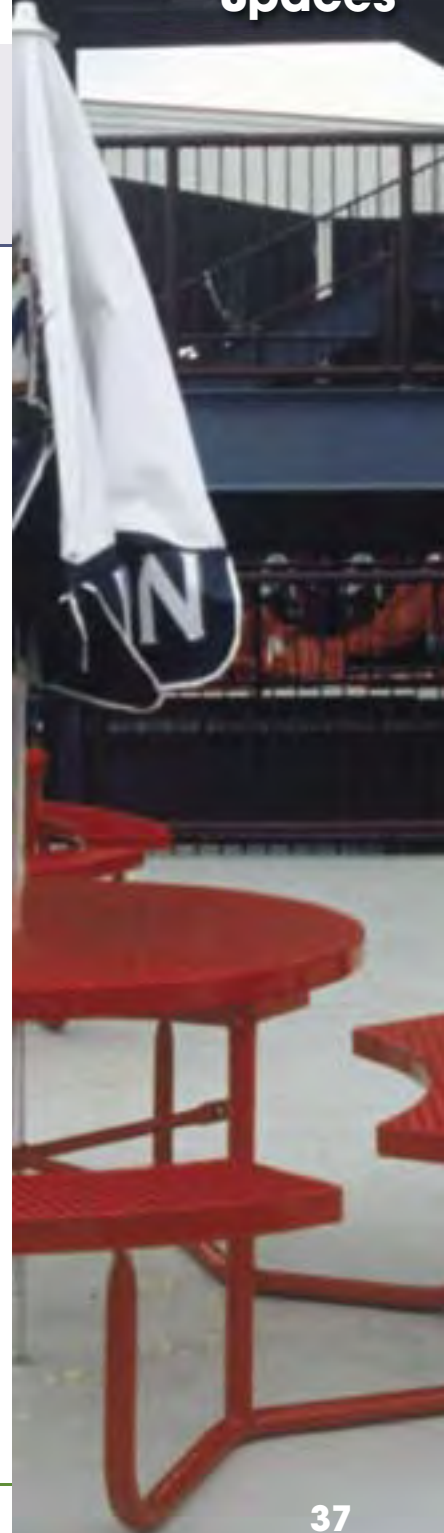

3.3 Recreation Facilities & Outdoor Spaces: 3.3.1 Public Building Entries & Arrival Areas

- All public building entries and arrival areas are to conform to the BCBC standards as a minimum. It is recommended that all park offices, comfort stations, and intermediate hiking/skiing cabins also conform to the BCBC requirements with the intention to create at least one accessible main entrance. If a main entry to a building does not conform to the accessibility standards of the BCBC, then a sign with both visual and tactile lettering shall be installed far ahead of any wheelchair obstruction, to the main entry to clearly indicate the location of the accessible entrance. The intent of Universal Design is to create main entries that are accessible to all without labeling them as accessible. The approach is meant to be invisible and equitable.
- While the interiors of all new public buildings are to conform to the BCBC, it is true that there are many pre-code public park buildings. An inventory of each building is recommended for upgrade of access by all park users.
- Within new and old park facilities, there must be provision for a person in a wheelchair to turnaround and manoeuvre unobstructed. The minimum clear floor space shall be 750 mm x 1200 mm [2' 5" x 3' 11"] to allow the passing of a pedestrian and a person using a wheelchair.
- If the building entry has an automatic door, and it is a swing door, then a clear area of 1500 mm x 1500 mm [4' 11" x 4' 11"] minimum is required for the door to swing open without hitting a person waiting to pass through the entry.
- The manoeuvring area at building entries and in front of doors, in general, shall be level and located on the push and pull sides of the door. The additional floor area at the latch edge of any door (automatic or otherwise) is required so that a person in a wheelchair or with a guide-dog can approach the door, activate the door handle, swing the door open, and pass through it without having to back up.

Accessible Building Entrance, Pitt Meadows City Hall, Pitt Meadows, B.C. / photo credit: Manfred Wuensche



- Where a door leads to a ramp landing, an additional area may be required. The CSA standards are very useful in simplifying this information with tables and illustrations of various door approaches, maneuvering areas at doors, and approach patterns to doors.
- If a mud grate is placed in front of the door into a park facility, the grate should be a square grid pattern and made flush to the door entry threshold and the path edge. The square grid pattern has squares no greater than 13 mm [0.5"] square.

3.3 Recreation Facilities & Outdoor Spaces: 3.3.2 Doors, Door Handles & Thresholds

- Automatic parallel sliding doors should be provided into public buildings. There are two types of operation to such power assisted doors, they are either hands free and activated by a motion detector or floor sensor pad, or manually activated with automatic push button door openers. The devices for either type of operation have to be located on both sides of the door entry at main entries and exits.
- Power-assisted doors have specific door opening forces and closure delay timing which shall conform to Universal Design best practices and standard industry specifications. The CSA provides specific criteria for door closers, opening forces, and cane-detectable guardrails and tactile surfaces.
- If a door is equipped with a closer and is power assisted, it should take three seconds or more to fully open and remain fully open for at least five to ten seconds or more before starting to close. The door should automatically stop closing if it finds that it is obstructed (not unlike an elevator door when it is blocked).
- Exterior doors to comfort stations and public offices must have a minimum clear opening of 815 mm [2' 8"]. In a typical installation, a door width of 900 mm [3'] is required to achieve a clearance of 815 mm [2' 8"] and swing-clear hinges are often used to increase the clear openings without enlarging a door frame.
- Doors and door frames that contrast in colour to the wall surface, enable people to more easily locate the door if they have a visual impairment.
- Thresholds should be no more than 13 mm [0.5"] high and beveled with a slope no greater than 1:2.
- Automatic parallel sliding doors are preferred as exterior doors to park facilities, but where impractical, large lever handles are recommended.
- All door hardware shall be operable by one hand, closed fist. The hardware should be levered hardware and be in colour contrast to the door surface. Push plate/door pull and U shaped hardware is also acceptable.
- Knob handles and thumb-latches often seen on doors are not appropriate because they cannot be opened by an arthritic hand or a closed fist. For example, a tight grasp and fine finger

Parallel Automatic Sliding Doors – North Vancouver, B.C. / photo credit: Donna Rodman



Automatic Door, Wall Mount – Vancouver, B.C. / photo credit: Donna Rodman



- control can be difficult for the senior or a person with Parkinsons or Cerebral Palsy.
- The door assembly should operate when a force of not more than 38 N (for exterior doors) and 22 N (for interior doors) is applied at the handle, push plate, or latch-releasing device.
- Handles, pulls, latches or locks shall be mounted 800 to 1200 mm [2' 7" to 3' 11"] from the floor. Where children are using the facilities, the height of 800 mm [2' 7"] should be implemented except in and around pool enclosures or other areas deemed unsafe. Access for children through doors and gates is to be allowed by a supervising and attending adult.
- A 300 mm [12"] kick plate is recommended for public park facilities with heavy use, such as washroom doors. A kick plate is recommended to be used on both sides of the door.

3.3 Recreation Facilities & Outdoor Spaces: 3.3.3 Children's Play Areas

To nurture children's learning, their needs and preferences must be considered. A fundamental factor is the design of their play environment and its ability to support their nurturing. Children are sensitive, caring human beings who interact with their environment in a very intimate manner. To have a child return repeatedly to a play site is a compliment to the designer and is an indication that the designer has addressed and met the deeper needs of a child in their play development and their play places. The fundamental principles for the planning and design of play spaces must include:

- Diversity
- Sequences of movements
- Manipulation
- Stimulus for cognitive play
- Stimulus for social play and interaction
- Graduated challenge
- Safety and security
- Simplification

Flexibility and ease of use are integral to universal access. To a child with varying levels of ability, play can be fun or it can be difficult. Whether they can access the play environment and be included with other children makes the difference between a well-adjusted child who succeeds later in life and a child who struggles with their own attitudes toward barriers or the attitudes of others towards them.

Another side of playground design is facilitating the access and supervision of the play space by a parent or grandparent. The adult who accompanies a child may or may not have the ability to actively engage and access a play space and therefore, the principles of Universal Design can apply so that they can participate in play with children. Having a bench with access seating and a wheelchair pad under shade or shelter in close proximity to a play space is a recommendation in the design of play spaces. The ability of a parent who may be in a wheelchair to enter the play space area to reach a child is also an important criteria for making a play space universal. (Rodman, D., 1999)



Variety Park Playground – Central Park, Burnaby, B.C.
photo credit: Donna Rodman



3.3 Recreation Facilities & Outdoor Spaces: 3.3.3 Children's Play Areas

Pitt Meadows Elementary School Accessible Playground – Pitt Meadows, B.C. / photo credit: Manfred Wuensche



- Access should be provided to all the activities offered in the play area. If there are three swinging activities, at least one shall be accessible to the child with a disability.
- Hard surface areas shall be clearly defined so children with disabilities can approach and transfer onto equipment.
- Where possible, the specifying of play equipment should include features that can be used by all children and children with attendant adults, for example a double-width slide.
- Ramps shall be 1200 mm [3' 11"] wide and sloped no more than 8%, and shall include handrails at varying heights from 550 to 950 mm [1' 9" to 3' 1"] in vertical distance between the ramp surface and the top surface of the handrail.
- Landings shall be a minimum of 1500 mm x 1500 mm [4' 11" x 4' 11"].
- All children's play areas shall conform to the latest edition of *Children's Playspaces and Equipment (CAN/CSA-Z614-03)*.
- At any measured point, the play area and protective surfacing shall extend a minimum of 2 m [6' 6"] from the nearest piece of equipment.
- Bulk fibre surfacing materials should be installed around and beneath all accessible activities and components of the play structure. In some cases, synthetic surfacing materials should be applied and much depends on the accessibility requirement of the play structure and the level of maintenance required for upkeep of the play area. In addition, the fall tables need to be consulted for the depth of materials to be used under various equipment components.

3.3 Recreation Facilities & Outdoor Spaces: 3.3.4 Water Parks

Maple Ridge Water Park – Maple Ridge, B.C. / photo credit: Petra Frederick



- Water play areas and spray pads must be made accessible to participants and to the adults attending to children.
- The facility should be served by an accessible pathway and be accessible to emergency vehicles.
- Accessible change rooms and parking areas should be provided close by.
- The washroom facilities for the water park should be located at least 100 m [328'] away from the water park facility.
- Both the surrounding deck and water play area should be of a slip-resistant material, and should have a visual and tactile difference between one another. Contrasting colours and material changes should be integrated into the design to denote transition zones between activity areas.
- There shall be at least one ramp with a handrail entrance into the water play area. An alternate route to the water play park is to be provided should there be a topographic barrier.
- All drain covers and skimmer grates, shall be flush with the deck/spray pad surface and have no opening more than 6 mm [0.25"].
- Shaded seating areas are to be provided adjacent to the water park and spray pad and these are to be integrated into the design so that different vantage points are possible for attending adults or observers.

Variety Park Playground – Central Park, Burnaby, B.C.
photo credit: Donna Rodman

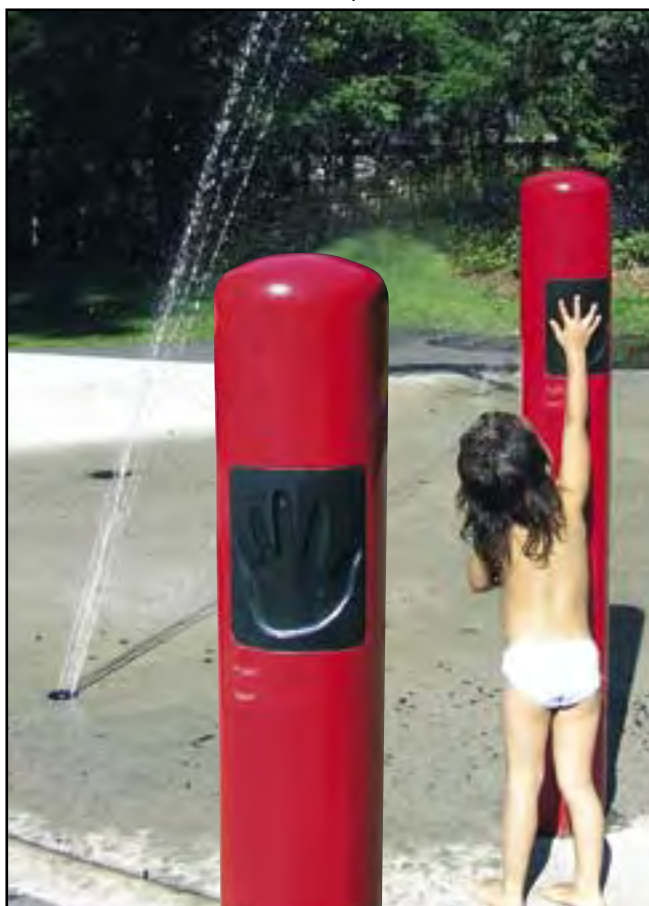

- If major water play facilities are developed, play areas for both younger and older children are to be designed so that the play activity can be separated within the water play park facility.

3.3 Recreation Facilities & Outdoor Spaces: 3.3.5 Outdoor Amphitheatres

- Often a ramp to a stage or upper platform is forgotten when in fact it is useful for not only accessibility but to move equipment up onto an outdoor stage area. The ramp structure should be integrated into the platform design so that it is secured to the stage, is safe, and at the maximum slope of 8.33%. All accessibility requirements for the design of ramps are to apply.
- Parking for outdoor amphitheatres should be as close as possible to the venue. An accessible walkway to the facility is required.
- If there is a lawn area for participant seating, shading from the sun should be provided using structures designed to create shade or trees with un-obstructing canopies.
- Seating areas should be provided that are easily accessed from the accessible pathway. These areas are to be shaded and sheltered.
- If possible, providing a variety of locations for accessible seating with direct sight lines to the stage area is recommended.
- Consider the use of assistive listening systems for visitors with hearing impairments. There are three primary listening systems: Induction Loop,

FM, and Infrared. They can be site specific, the system should be reviewed by an acoustic professional before being implemented.

- The standards for outdoor amphitheatres are flexible but as a minimum should provide two designated seating spaces for capacities under 100. For capacities between 100 and 400, 4 designated seating areas, and 1% of the total capacity for over 400.

Accessible Seating Area – Fenway Park, Boston Massachusetts / photo credit: Donna Rodman



3.3 Recreation Facilities & Outdoor Spaces: 3.3.6 Registration & Condiment Counters

Recent research into the differences between people with disabilities and the type of mobility devices used is showing that the heights of counters, and the reaching distances for depths of counters vary significantly from the prescriptive CSA dimensions. The differences stem from variables that include device dimensions, the level of disability in upper limbs, and the functional movement of the person. There is a need to re-consider and re-evaluate present codes and standard dimensions, for example, in terms of low reach, forward reach, forward high reach, and bending reach.

- A two-level registration desk, with the lower section a minimum 1000 mm [3' 3"] long, 760 to 860 mm [2' 6" – 2' 10"] high, and with a clear depth of 500 mm [1' 8"] allowing knee space for people in wheelchairs and scooters should be provided.

- Reach ranges refers to the maximum and minimum heights that a person in a seated position can reach. There is the forward reach and the side reach. If a person in a wheelchair can approach alongside a counter and reach the napkin dispenser from the side of the chair, the reach range will be greater than if the object can only be approached from the person reaching forward.

Accessible Condiment Stand Fenway Park, Boston, Massachusetts photo credit: Donna Rodman



- Objects which need to be reached include paper napkin and condiment dispensers.

Boat Launch and Fixed Dock Facility – Tour of Providence, Rhode Island / photo credit: Donna Rodman

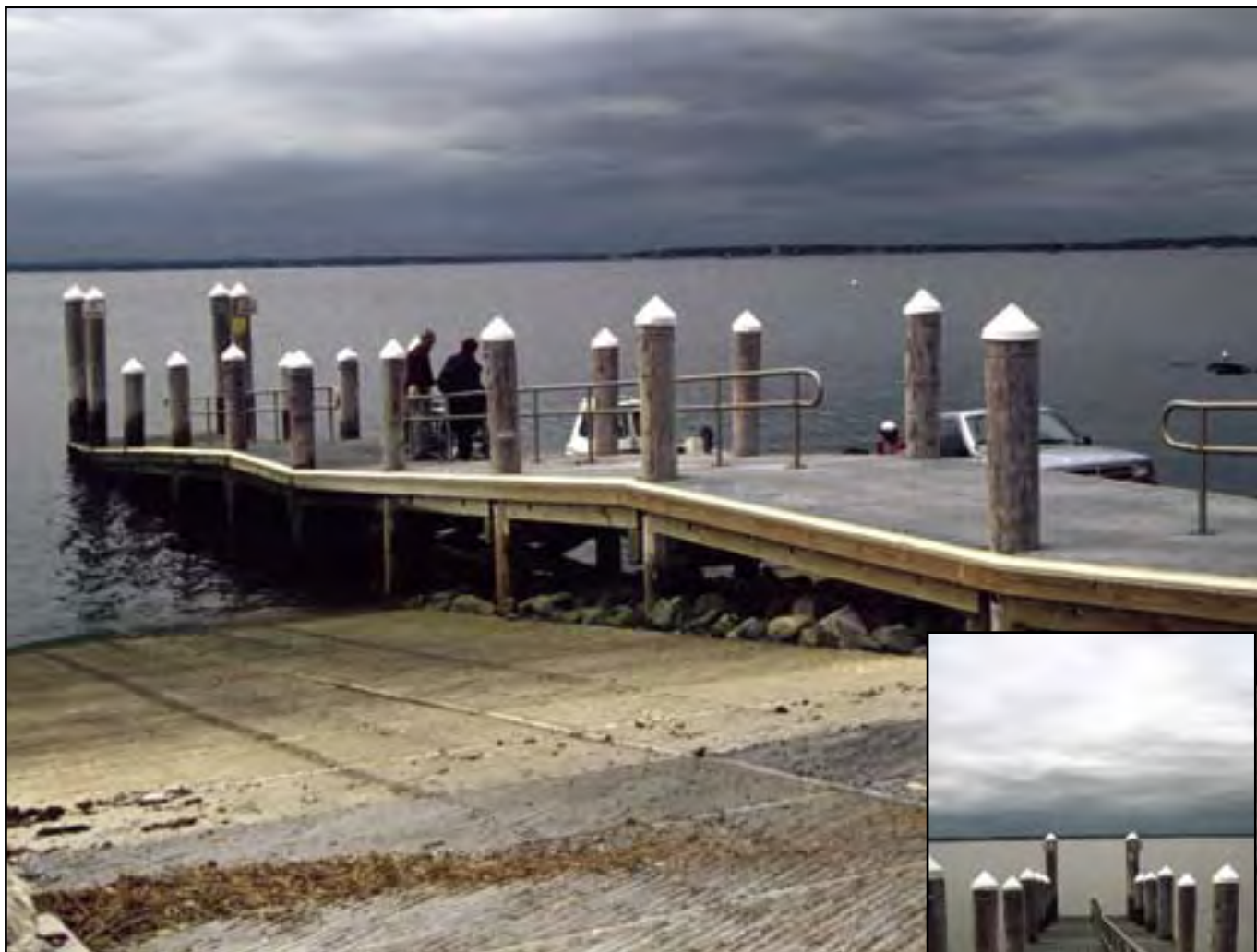

- Guidelines for sailing facilities and boating launches in roaded, natural settings are not covered here. Guidelines in urban/rural settings where supervision is available are provided.
- Accessibility and safety is the central focus in the design of boating areas and the liability issues can be significant. Facilities specifically designed with hoists and slings and having experienced personnel on hand to assist with loading and launching are recommended for sailing and boating functions.
- In general, access to dock facilities is provided by ramps with handrails. The positioning of ramps must take into account tidal changes, seasonal water fluctuations, or periodic releases from dams and reservoirs.
- Because of the inherent dangers created by proximity to water, the slope of gangways should never exceed 1:12 and this requires careful planning design. In some cases, a series of gangways with switchbacks is required.
- Tactile warning strips are required at the edges of boating docks. Supervision of the dock facility by experienced water-certified personnel is required if a person with a visual impairment chooses to use the facility.

Figure 3.15 – Canoeing and Kayaking Jetty (The Finnish Association of Sports for the Disabled: Outdoor Recreation for Everyone)

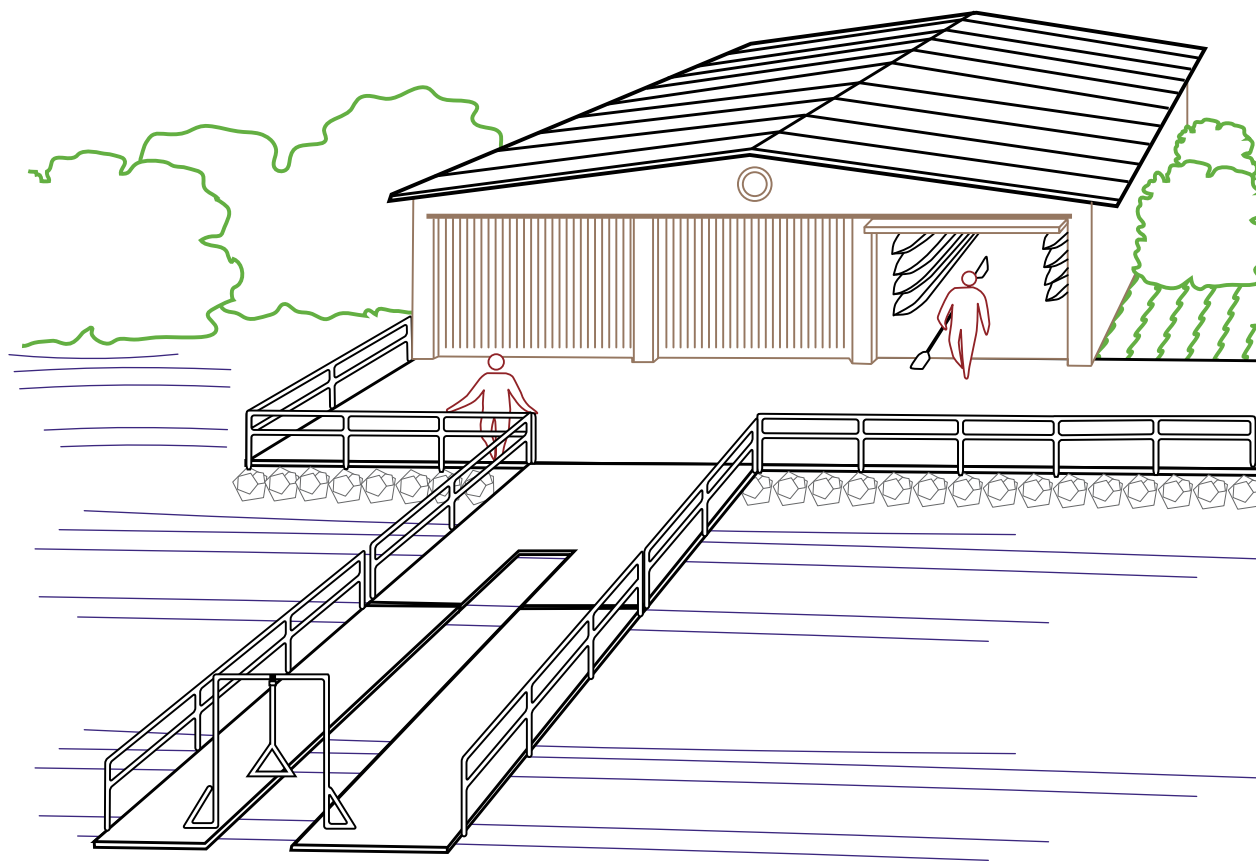

- Dock platforms and dock boardwalks shall have slip resistant surfaces and contain kick rails or edge curbs created by a raised barrier or rail with its lower edge not more than 75 mm [3"] from the dock surface. The height of the curb is to be 102 mm [4"].
- A graspable raised rail is an advantage for individuals moving from the dock surface into a kayak or canoe. The rail also services to attach the painters to secure the kayak or canoe.
- For kayaking and canoeing activities, there are unique and site specific solutions available to modify dock facilities to accommodate everyone. Designs include skid piers where the position of the boarding deck is manually changed with the water level or floating docks (the most common) attached to a fixed pier or abutment on the shore. The floating dock is particularly bothersome with balance and visual impairments. An example of a kayak and canoe jetty is illustrated and demonstrates an option that actually works for everyone attempting to get into a tippy canoe.
- The first purpose of a boat launch is to launch boats and a minimum slope of 12 to 15% is required for this function. Although this exceeds the maximum slope for an accessible route, it is acceptable. Boaters with disabilities will find that coping briefly with a steeper slope less of a bother than attempting to launch and retrieve a boat from a ramp with a lesser grade. (Wilson, 1991)

3.3 Recreation Facilities & Outdoor Spaces: 3.3.8 Horseback Riding Facilities

- Accessible horseback riding facilities should provide access to the place where horses are corralled and stabled. Access to horse care areas is very important.
- A means to transfer onto and off of the horse shall be provided.
- A transfer platform will assist some people with disabilities in transferring onto or off of a horse. The transfer platform must allow a person to get to the level of the saddle stirrups. Horses come in different sizes and so do people who want to ride them. All transfers should be supervised.
- In order to assist the transfer from the platform to the horse, an attendant can be standing on another platform positioned right across from the transfer platform or they can be standing on the ground. In both cases, the horse should be held by a third person. There are numerous designs available to create transfer platforms for mounting horses. One of the best seen to date comes from the Finnish Association of Sports for the Disabled. In their design, the horse is led between two platforms located opposite each other.
- The height of the platform depends on the sizes of both the rider and the horse. When a platform is fractionally too low, it is possible to mount a horse either independently or with the help of an assistant, but if a platform is too high, it is difficult to use.
- It is possible to use a hoist to lift a person onto a horse, however the horse will require training to accept the use of this device.
- It is possible that a transfer platform can be integrated into the contours of the terrain that surround the riding space so that a ramp may not be necessary.

Equestrian Trail – Maple Ridge B.C. / photo credit: Donna Rodman



Complies
Achievable
Does Not Comply



Standard Guidelines for Equestrian Platforms:

Figure 3.16 – Equestrian Mounting Platform

p47

A, B, C, D, E, F

- A** The surface of an accessible transfer platform must be level and at least 1526 to 1830 mm [5' – 6']. It must be able to accommodate the rider and an attendant to help with the transfer.
- B** The platform must be raised at least 610 mm [24"] above the ground surface.
- C** The platform must be accessible by a ramp of a maximum 8.33% slope.
- D** A handrail that is 760 to 865 mm to [2' 6" to 2' 10"] high should be provided on at least one side of the platform.
- E** Edge protection from drop-offs should be provided in developed settings. Protection should be accomplished with 102 mm [4"] high curbs at platform and ramp edges.
- F** Closed Stair Risers. (Refer to Section 3.1.3 Ramps, Stairs and Stramps for more information.)

Figure 3.16 – Equestrian Mounting Platform – (The Finnish Association of Sports for the Disabled: Outdoor Recreation for Everyone)

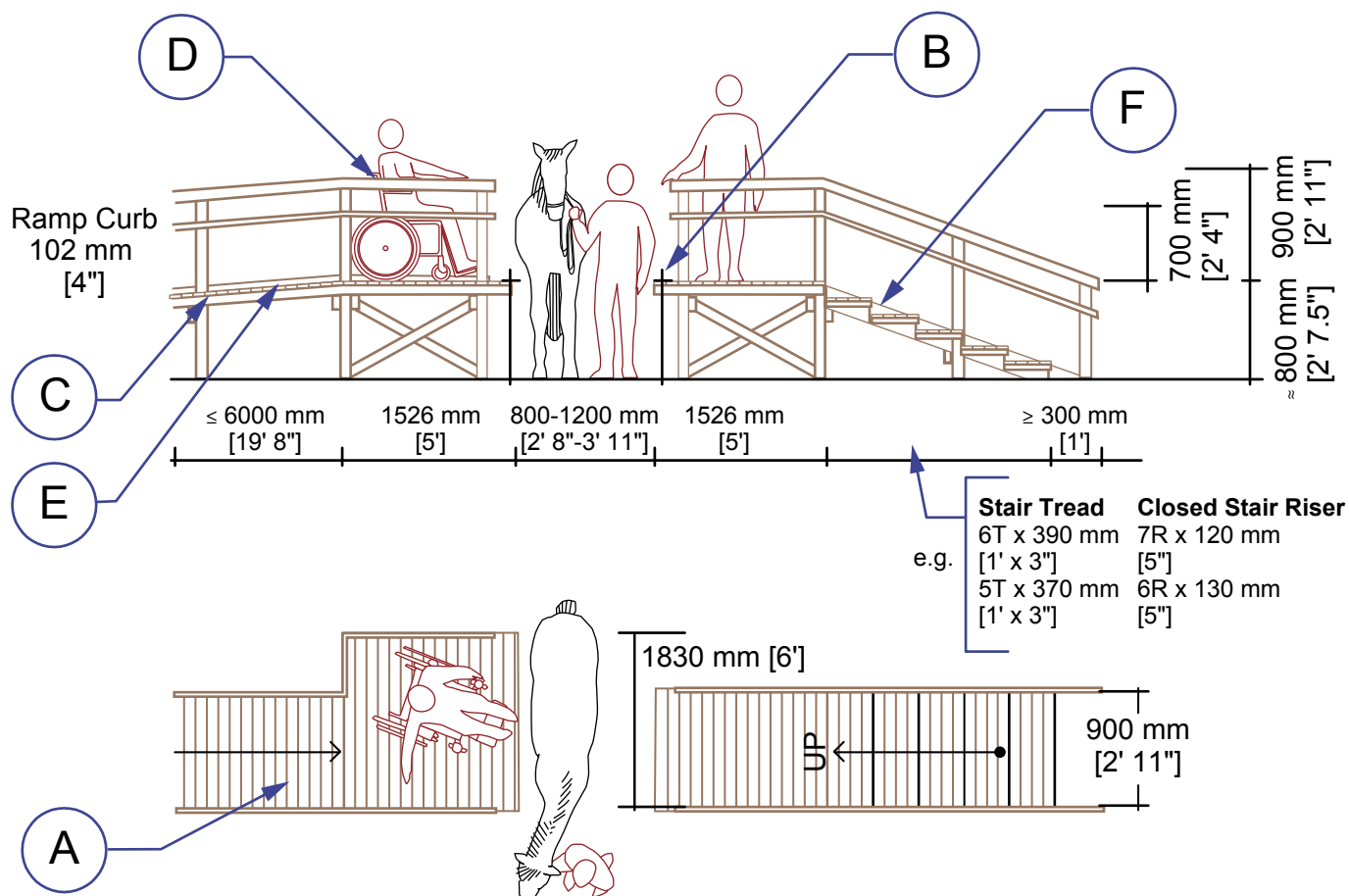

3.4

Park Services, Trail Signage & Campgrounds

3.4 Park Services, Trail Signage & Campgrounds

3.4.1	Washroom Facilities	49
3.4.2	Outhouses	50
3.4.3	Public Showers	51
3.4.4	Water Taps & Hand Pumps	52

	Standard Guidelines for Water Taps & Hand Pumps: - p52	<i>Figure: 3.17 – Water Taps and Hand Pumps</i>	52
---	---	---	----

3.4.5	Drinking Fountains	53
3.4.6	Benches	54
3.4.7	Trash Receptacles & Recycling Bins	55
3.4.8	Site Lighting	56
3.4.9	Battery Recharge Facilities	57
3.4.10	Telephones	58
3.4.11	Accessible Picnic Tables	59

		<i>Figure: 3.18 – Accessible Picnic Table</i>	60
3.4.12	Accessible Campsites		61

	Standard Guidelines for Accessible Campsites: - p62	<i>Figure: 3.19 – Accessible Campsites</i>	63
---	--	--	----

3.4.13	Walkways & Pathways	64
3.4.14	Trail Signage	65

	Standard Guidelines for Trail Signage: - p66	<i>Figure: 3.20 – Trail Signage</i>	67
---	---	-------------------------------------	----

3.4.15	Boardwalks (over water)	68
--------	-------------------------	----

	Standard Guidelines for Boardwalks: - p69	<i>Figure: 3.21 – Boardwalk Plan View</i>	69
		<i>Figure: 3.22 – Boardwalk raised less than 600 mm over water</i>	70
		<i>Figure: 3.23 – Boardwalk raised greater than 600 mm over water</i>	70

3.4.16	Fishing Platforms	71
--------	-------------------	----

	Standard Guidelines for Fishing Stations on Dock Facilities: - p72	<i>Figure 3.24 – Fishing Dock Elevation View</i>	73
		<i>Figure 3.25 – Fishing Dock Plan View</i>	73

	Standard Guidelines for Fishing Stations in Natural Settings:- p74	<i>Figure 3.26 – Fishing Dock Elevation</i>	74
---	---	---	----

3.4.17	Beaches	75
3.4.18	Outdoor Pool Decks	76

3.4 Park Services, Trail Signage & Campgrounds: 3.4.1 Washroom Facilities

- Restrooms in developed settings use forms, materials and building standards for accessibility common to the built environment.
- Doors to accessible washroom stalls should swing outward 90°, and have an opening of 900 mm [2' 11"]. Stalls should be a minimum of 1500 x 1500 mm [4' 11" x 4' 11"] and be designed to provide manoeuvring space up to each fixture.
- The doors of accessible washroom stalls should have a graspable handle on the inside face of the door located 90 mm [3"] from the hinge edge of the door and 915 mm [3'] above the finished floor. This enables a person to close the door by reaching behind and using the handle.
- Flushing mechanisms for the toilets can range from automatic or electronic flush, to manual flush, to no flush (as in an outhouse). The manual flush levers need to be of the lever type of handle and easy to access from a sitting position.
- Two horizontal bars shall be provided as per the BCBC.
- Coat hooks at 1200 mm [3' 11"] above the finished floor allow both people in wheelchairs and children to hang coats. The coat hooks are to be on the inside of the stall door and not protrude more than 40 mm [1.5"] from the wall.
- All washroom dimensions and fixtures shall conform to the accessibility requirements of the BCBC. The BCBC is very clear on the requirements for accessibility of fixtures such as sinks, paper towel dispensers, mirrors, toilets, and toilet paper dispensers. The standards are adequate. And failing this, if an item is not covered by the BCBC, the *CSA Barrier Free Design – CAN/CSA B651-M90* should be consulted.
- The CSA has specific criteria for urinals and should be consulted when they are being installed. The height range for the well of the urinal is intended to allow persons in wheelchairs as well as people standing and children, to use the urinal. Interestingly, directional marker strips to help people with visual impairments to find the urinal within a washroom are rarely used but highly recommended within the practice of Universal Design.

Outdoor Public Washroom – North Vancouver, B.C. / photo credit: Donna Rodman



3.4 Park Services, Trail Signage & Campgrounds: 3.4.2 Outhouses

Accessible Washrooms – South Bonson Neighbourhood Trails, Pitt Meadows, B.C. / photo credit: Natasha MacArthur



- Public toilets that are located in highway wayside rest areas, campgrounds, picnic grounds, parks, trailer parks, and mobile home parks need to comply with the BCBC standards.
- Access from a roadway to at least one of the toilet buildings by means of a fully accessible path is required.
- Restrooms in lesser developed, roaded natural settings are simple in design and still adhere to the accessibility standards of the BCBC. However, flushed toilets are not the norm yet, the standard heights of accessibility for the toilet should be adhered to with grab bars and transfer spacing for a side transfer. The BCBC requires that the top of the toilet rim is to be 455 mm [1' 6"] above the finished floor.
- The metal mud mats often placed in front of exterior doors of outdoor washrooms should be made flush to the door entry threshold and the path edge and have a square grid pattern with squares no greater than 13 mm [0.5"] square. Often such mats create difficulties for people in wheelchairs or using mobility aids to access outdoor washroom facilities. However, they are required to prevent the accumulation of water and mitigate erosion from the foundation or sill of the door entry into the outdoor washroom facility.
- D-shaped handles or levered hardware are recommended as door hardware for outdoor washroom doors. Knobs that turn are difficult to grasp and rotate if a hand has become arthritic or weakened by a disability. If the washroom has locks, then signage should give directions as to where keys are available for access.

- The BCBC has very good standards set for shower facilities that meet the requirements of people with disabilities. It is recognized that not all public showers in outdoor spaces can be as accommodating as those showers that are roll-in showers and built in public gyms, swimming pools, and dormitories. What is reasonably achievable should be implemented in outdoor facilities such as campsites and beaches and in fact, some very creative solutions have been found to provide this amenity for everyone. Roll-in shower facilities are a requirement for a shower to be accessed by a person in a wheelchair.
- If a curb is required for a shower, then it shall not be higher than 100 mm [4"] and shall have a width of less than 100 mm. A colour-contrasted shower curb allows it to be visible and may help reduce the tendency to stumble over it in the shower.
- Shower stalls should be designed to allow persons to either shower while remaining in a wheelchair, or transfer to a bench (preferably fixed to the wall or strongly fastened to the wall and capable of being folded up) which does not interfere with manoeuvring. Benches should be colour contrasted from wall and floor surfaces.
- Showers should be fitted with handheld shower heads and hoses 1500 mm [4' 11"] long, and L-shaped grab bars.
- Operating controls should be electronically controlled or positioned so they are within easy reach while seated and operable with one hand.

Outdoor Public Showers – 2nd Beach, Stanley Park, Vancouver B.C./ photo credit: Donna Rodman



- The temperature of the water supplied to an accessible shower or bathtub shall not exceed 55° C. The temperature is to be controlled either by a thermostat or by a pressure-equalizing valve.
- All accessible showers should have flooring material that is slip resistant.
- All shower dimensions and fixtures shall conform to the accessibility requirements of the BCBC. And failing this, if an item is not covered by the BCBC, the *CSA Barrier Free Design – CAN/CSA B651-M90* should be consulted.
- Doors or curtains for shower stalls shall not obstruct the controls or the transfer space.
- Offsetting the drain of a shower to a corner rather than in the middle of the shower stall floor, helps to drain the water away from the floor surface to a corner leaving the shower stall floor primarily level.

3.4 Park Services, Trail Signage & Campgrounds: 3.4.4 Water Taps & Hand Pumps

- Accessible water taps and hand pumps should be located adjacent to a hard surfaced accessible walkway, and should be operable by a spring-loaded lever handle which allows a simple arm or hand motion to operate the pump.
- Hand pumps at park wells pose a particular problem since there are no hand pump designs readily available to provide the 5 lbf (22N) maximum operating force needed to make the hand pump accessible.

Complies
Achievable
Does Not Comply



Standard Guidelines for Water Taps & Hand Pumps:

Figure: 3.17 – Water Taps and Hand Pumps

p52 A, B, C, D

- A** A 1524 x 1524 mm [5' x 5'] concrete pad surrounding the tap should be provided and sloped away at 2% from the area of operation.
- B** If a grate is provided on the pad, it may have elongated openings, that should be placed so that the long dimension is perpendicular to the dominant direction of travel. Grates must have spaces no greater than 13 mm [0.5"] wide in one direction.
- C** The controls for both the water tap and the hand pumps must be front-mounted or side-mounted near the front edge of the unit and the lever handle for the water tap should be 800 mm [2' 7"] above the ground. Controls for the hand pump must not exceed a height of 1017 mm [3' 4"] above the ground.
- D** The spouts for both water taps and hand pumps should be located at the front (approachable) side of the unit. The spouts for both water taps and hand pumps must be no less than 715 mm [2' 4"] and no more than 915 mm [3'] above the ground.

Figure: 3.17 – Water Taps and Hand Pumps

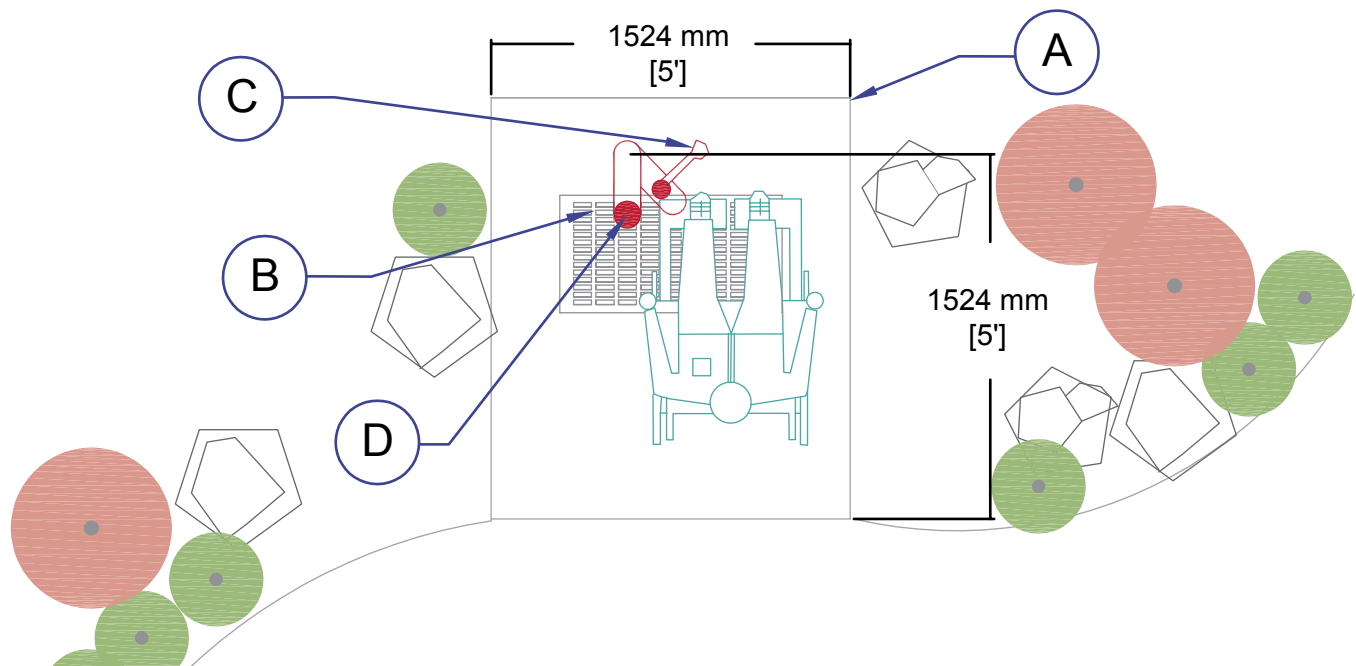

3.4 Park Services, Trail Signage & Campgrounds: 3.4.5 Drinking Fountains

- If provided, an accessible drinking fountain should be located adjacent to an accessible paved area or walkway. It should appear on the primary trail signage at the trailhead and if possible, on any maps prepared for the trail system.
- The BCBC has created specific requirements for drinking fountains in and around the built environment. In outdoor environments, at least one fountain should be made accessible if fountains are provided. There have been very creative designs put forth that allow adults and children to drink and these are recommended. However, providing leg room for a person using a wheelchair is necessary which means the new design requires at least a clearance under for knees and feet on footrests.
- The drinking fountains are to be located on firm, slip-resistant surfaces with positive 2% drainage to the perimeter so that water does not accumulate under the fountain.
- If a grate is provided on the pad, it may have elongated openings, and they shall be placed so that the long dimension is perpendicular to the dominant direction of travel. They must have spaces no greater than 13 mm [0.5"] wide in one direction.
- The ADA requires that wall- and post-mounted cantilevered units shall have a clear knee space between the bottom of the apron and the floor or ground at least 685 mm [2' 3"] high, 760 mm [2' 6"] wide, and 430 to 485 mm [1' 5" to 1' 7"] deep. Such units shall have a minimum clear floor space 760 x 1220 mm [2' 6" x 4'] to allow a person in a wheelchair to approach the unit facing forward.
- With freestanding or built-in units not having clear space under them (existing construction), the ADA requires a clear floor space of at least 760 mm x 1220 mm [2' 6" x 4'] that allows a person in a wheelchair to make a parallel approach to the unit.
- The water spout height is to be not less than 750 mm [2' 5"] nor more than 915 mm [3'] above the finished grade. It should be positioned at the front of the unit. On an accessible drinking fountain with a round or oval bowl, the spout must be positioned so the

flow of water is within 75 mm [3"] of the front edge of the fountain.

- The distance between the bottom of the basin and the underside of the spout should not be less than 100 mm [4"] to allow a cup or glass to be placed under the spout.
- An accessible drinking fountain should be operable by spring-loaded lever handle or electronically. The controls must be front-mounted or side-mounted near the front of the unit. The operation of the hardware should not require twisting, grasping, nor pinching.
- The BCBC requires that the force required to operate the lever handle should not be more than 22N.

Accessible Drinking Fountain – Maple Ridge Park, Maple Ridge, B.C. / photo credit: Petra Frederick



Accessible Drinking Fountain – Heritage Woods, Port Moody, B.C. / photo credit: Donna Rodman



3.4 Park Services, Trail Signage & Campgrounds: 3.4.6 Benches

- All accessible benches must have arm and back rests.
- Benches are to be stable and, in public space situations, are required to be anchored to a concrete pad.
- The CSA requires a bench seat to be at a height of 450 to 500 mm [1' 6" to 1' 8"].
- The front face of benches should be set back from the path of travel at least 600 mm [2'] so the required set back or depth for a seating area is 1220 mm [4'].
- The length of the bench space is dependent on the designer's intent, but the space should always include an additional 760 to 900 mm [2' 6" to 2' 11"] wide by 1220 mm [4'] deep space to allow a person in a wheelchair to park near other seated people. Extra space also allows an assistive dog to sit by their wheelchair companion.

Accessible Bench Seating – Pitt Meadows City Hall Benches, Pitt Meadows, B.C. / photo credit: Manfred Wuensche



- The trash receptacle industry has produced accessible trash receptacles over the recent years. These should be reviewed for outdoor open spaces with respect to accessibility and bear proofing in urban/rural settings.
- Trash receptacles, if provided, must be located along an accessible route.
- An accessible trash receptacle should be operable (openable) with one hand and have a hinged door which swings inwards, 750 to 900 mm [2' 5" to 2' 11"] above the ground.
- The new bear proof trash receptacles are particularly not accessible simply by virtue of the door being on top and having to be lifted up for access to the receptacle. From a sitting position this is difficult to impossible particularly when one also has to hoist a bag of garbage up and over the rim into the receptacle. For a person with a disability and limited range of motion, the elderly, and children, this is extremely challenging.
- Designers must balance the need for access with the need to inhibit scavengers. The force to open a hinged lid, whether it swings in, or swings up, must not exceed 5 lbf (22N).
- Trash receptacles must not have sharp edges.
- A minimum clear ground and floor space of 915 x 1220 mm [3' x 4'] must be provided adjacent to a trash receptacle. The space is required for either a parallel or forward approach to the trash receptacle.
- Large dumpsters are completely inaccessible and are not discussed here as there are none currently on the market that meet accessibility requirements.

Accessible Garbage Cans – Maple Ridge, B.C. photo credits: Natasha MacArthur



3.4 Park Services, Trail Signage & Campgrounds: 3.4.8 Lighting

- Glare on signage and on highly reflective pathways is particularly difficult for the field of vision for pedestrians and people with disabilities. It is also a problem for the elderly or those with glaucoma. The use of lighting fixtures which produce glare are to be eliminated. Light sources always should be properly baffled with louvers or lenses.
- Lighting poles should be located outside the path of travel.
- When light bollards are used, they should be spaced at least 1 m [3' 3"] apart, ideally 1.6 m [5' 2"] apart, so that circulation between the bollards is possible by everyone. At the same time, glare that is thrown up should be considered as this can blind a person at night. It is preferred that the bollard direct the light downward toward the pathway and the shrubbery.
- Pedestrian scale lighting or wall-mounted lights that protrude should provide a minimum of 1980 mm [6' 6"] overhead clearance according to the BCBC.
- Where practical, exterior lighting should be provided along all accessible walkways providing access to/from such park facilities as visitor centres, registration offices, comfort stations, washrooms, outdoor amphitheatres, parking lots, firewood lots, and water stations. As well, pedestrian lighting should be provided where changes in elevation occur along pedestrian routes and at transition and pathway intersections.
- Tree canopy maintenance should be a regular, ongoing activity to insure that pruning occurs to remove branches that block pedestrian scale lighting from reaching pathway and surrounding surfaces at night.
- When positioning ground level lighting, the principles of crime prevention through environmental design should be applied so that not only are pathways lit but the surrounding shrubbery is also lit along an exterior pathway leading from a point A to B.
- In preparing or reviewing a lighting plan, the type of light, light level, and lighting pattern are important. Uneven distribution of light can hide obstacles, distort the walk surface,

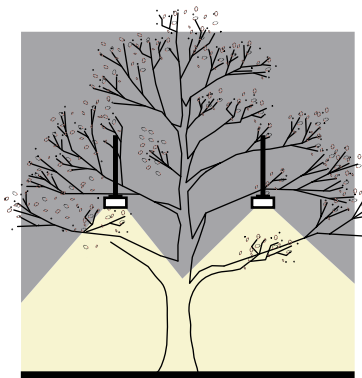

Spread Lighting

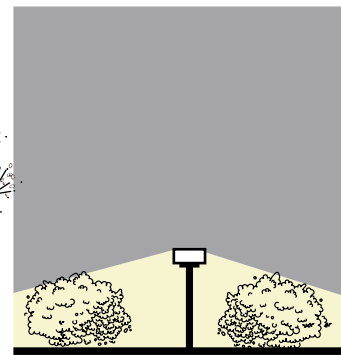

Lighting Shrubs that line a pathway expands visibility of pathway corridors.

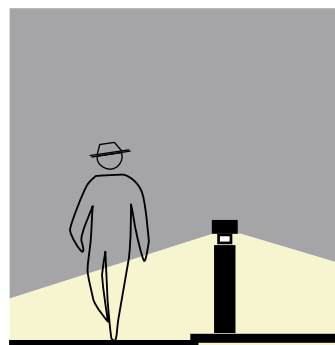

Path Lighting

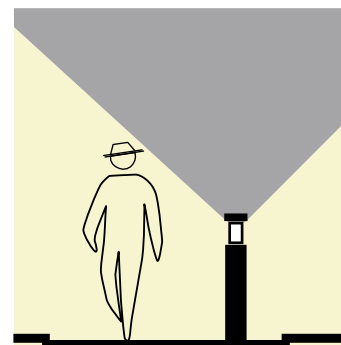

Not a preferred pathway lighting due to glare.

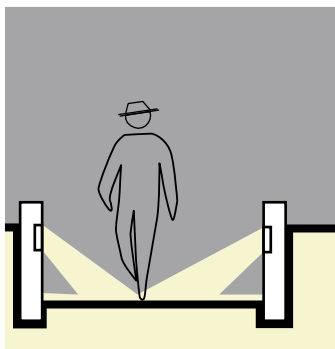

Wall Lighting

or confuse pedestrians, causing them to concentrate on the path ahead rather than looking at the areas around them. People feel far more secure and comfortable moving along a dimly lit path as long as they are surrounded by or walking toward a higher light level. It is recommended to contact lighting suppliers who have specialists on their teams who prepare lighting plans based on product information and industry standards.

3.4 Park Services, Trail Signage & Campgrounds: 3.4.9 Battery Recharge Facilities

- 95% of scooters carry two batteries which require recharging on a regular basis. A 24 Volt (3 Amp) charger is required to charge the batteries within a home environment using the domestic power supply at 120 Volts.
- Depending on the capacity of each battery to retain its charge, a person in a scooter can go about their day unconcerned and can recharge their scooter's battery over an 8 hour period in the evening.
- For camp and picnic sites, it is recommended that each accessible site have an electrical outlet for the purpose of users to recharge scooter batteries. The outlet can be attached to a picnic table or be found at the base of a light standard. Outlets should be located to allow the batteries and chargers to be placed at a reachable level while the batteries charge.
- In the urban, rural park, or where a pocket park exists within a subdivision, it is recommended that an electrical outlet be available and be indicated as accessible by signage. Such outlets would be either attached to a picnic table, bench, or light standard.
- In consulting with lighting experts at Hubbell Canada's Vancouver distributor, Litesource Industries, a light standard was sourced that offers the option of a 15 Amp 120 Volt ground fault circuit duplex receptacle (GFCI) for exterior applications. The receptacle sits at the base of the light standard and has a gasketed cover. Everyone can access the receptacle and no special tool or instrument is required to plug in. The location of the receptacle on the pole needs to be specified and it is recommended that the accessible height be similar to that found in the home environment of approximately 300 mm [12"] above finished grade. The light standard needs to be accessible from the pathway or sidewalk. Such options for recharging batteries for chairs and

*Picnic Table with Battery Recharge Outlet – Heritage Woods, Port Moody, B.C.
photo credit: Donna Rodman*



scooters would be helpful in an emergency when the battery level drops too low while in an outdoor park or on top of a hilly pathway. Signage at the entry of the park would be required to explain this particular accessible benefit to users.

*Battery Recharge Outlet –
Maple Ridge Fairgrounds,
Maple Ridge, B.C.
photo credit: Donna Rodman*



3.4 Park Services, Trail Signage & Campgrounds: 3.4.10 Telephones

- With the advent of the cell phone, much of the need for public telephones in outdoor spaces has been reduced. If cell phones are not within the range of the cell towers, then public pay phones still serve a purpose. They also are needed in areas where emergencies may occur such as at beaches, outdoor pools, and scuba diving sites.
- The standards for public telephones have been regulated for accessibility for many years and do not need repeating. The BCBC however, created a situation where if more than one public telephone is installed, at least one shall be accessible. Unfortunately, in open outdoor spaces, usually only one phone is made available. Subsequently, the ADA stated clearly that if one public pay phone is made available in a public place, the phone must comply with accessibility guidelines. With Universal Design, the condition of one phone being present, requires that it be accessible to all.
- The exception still is public text telephones (TTY/TT) for people with hearing or speech impairments. If there is a bank of four public phones (including both interior and exterior phones) at an outdoor site or facility such as an amphitheatre, ball park, sports stadium, or pool, at least one interior public text telephone (TTY/TT) must be made available. The public pay phone must come equipped with a text phone shelf and electrical outlet, and the text phone device itself must be available at a site office. The likelihood of a public text telephone device (TTY/TT) being in roaded natural settings or public campsites is slim as TTY/TT phones are additional, portable equipment that must be attached to the handset of a public pay telephone. Campsites can meet accessibility requirements if they have a TTY/TT phone available at the site office. For outdoor open spaces, cell phones or iPods with text messaging are the most practical for people with hearing or speech impairments.
- If an accessible campsite or an outdoor public recreation facility has the text telephone, they are required to post directional signage indicating the location of the text phone and use the International TTY Symbol (TDD) to indicate availability of a text phone or a teletypewriter.
- All operable parts of an accessible telephone, including the coin slot, shall be no higher than 1200 mm [3' 11"] from the ground.
- Push button controls shall be used where possible and the phone is to be equipped with volume controls and a hearing aid coupler coil. Signage shall be posted at the entrance or site supervisor's office indicating that a volume control phone is available. Volume controls on telephones are useful for everyone particularly in locations with high noise levels.
- Unobstructed access must be provided to within 300 mm [12"] of the front of the telephone with a clear, firm ground space being not less than 760 x 1220 mm [2' 6" x 4'] so that a person using a wheelchair or scooter can either make a forward or parallel approach.
- A telephone directory shelf 500 mm wide x 350 mm deep [1' 8" x 1' 2"] should also be provided.
- The cord length for the handset shall be a minimum of 735 mm [2' 5"].



Symbol for People Who are Hard of Hearing for a Volume Control Phone

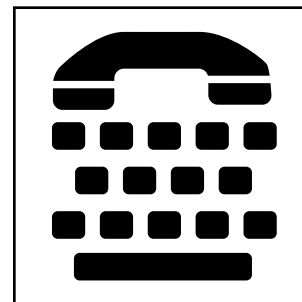

International TTY Symbol (TDD) for Teletypewriter Phone or Text Phone

Accessible Picnic Table – Yew Lake Trail, Cypress Bowl, West Vancouver, B.C. / photo credit: Donna Rodman



- Accessible picnic tables should be situated in different locations throughout a site to provide a variety of choices and to take advantage of the area's natural features. Some picnic areas should be provided in shady areas and others located where they have direct sunlight. Some should be clustered together to allow for group gatherings, others near site amenities such as athletic facilities and covered cooking facilities (for that moment of sudden rain). Segregated *special* areas are neither appropriate or desirable.
- An accessible picnic area should include nearby universal parking for both vans and automobiles.
- An accessible walkway shall connect the universal parking area with the accessible picnic area. The grade should be level (not exceeding 5%), be well drained, and be of a non-slip surface that can include materials such as granite fines, asphalt, or brushed concrete.
- The accessible walkway must be kept clear of leaves and plant debris so that it does not become slippery when wet. View lines from the pathway should be directly to the accessible picnic area if possible.
- If the natural site is developed with washrooms, accessible picnic sites and water stations shall be no further than 100 m [328'] away, and connected with a walkway.
- A picnic area that is accessible shall include an accessible picnic table and trash receptacle. If cooking facilities are provided at the end of the picnic table, the cooking surface shall be between 450 to 600 mm [1' 6" to 2'] from the ground.
- The picnic table shall be anchored on a hard surface pad (i.e. asphalt, screenings, pavers, or concrete) with positive drainage toward the edges. Maintenance of the pad is required to address erosions around its edges so that the pad remains flush to the existing grade and does not have a difference in level. Any difference in level shall not exceed 13 mm [0.5"].

3.4 Park Services, Trail Signage & Campgrounds: 3.4.11 Accessible Picnic Tables

- Ideally, an accessible trash receptacle would be part of the picnic station and close to the accessible picnic table. However, due to potential bear visits, the location of the trash receptacle shall be determined by the parks department in relation to the accessible picnic area.
- Where group picnic facilities are provided, accessible picnic stations shall be placed a minimum of 2.5 m [8' 2"] apart.

Figure: 3.18 – Accessible Picnic Table

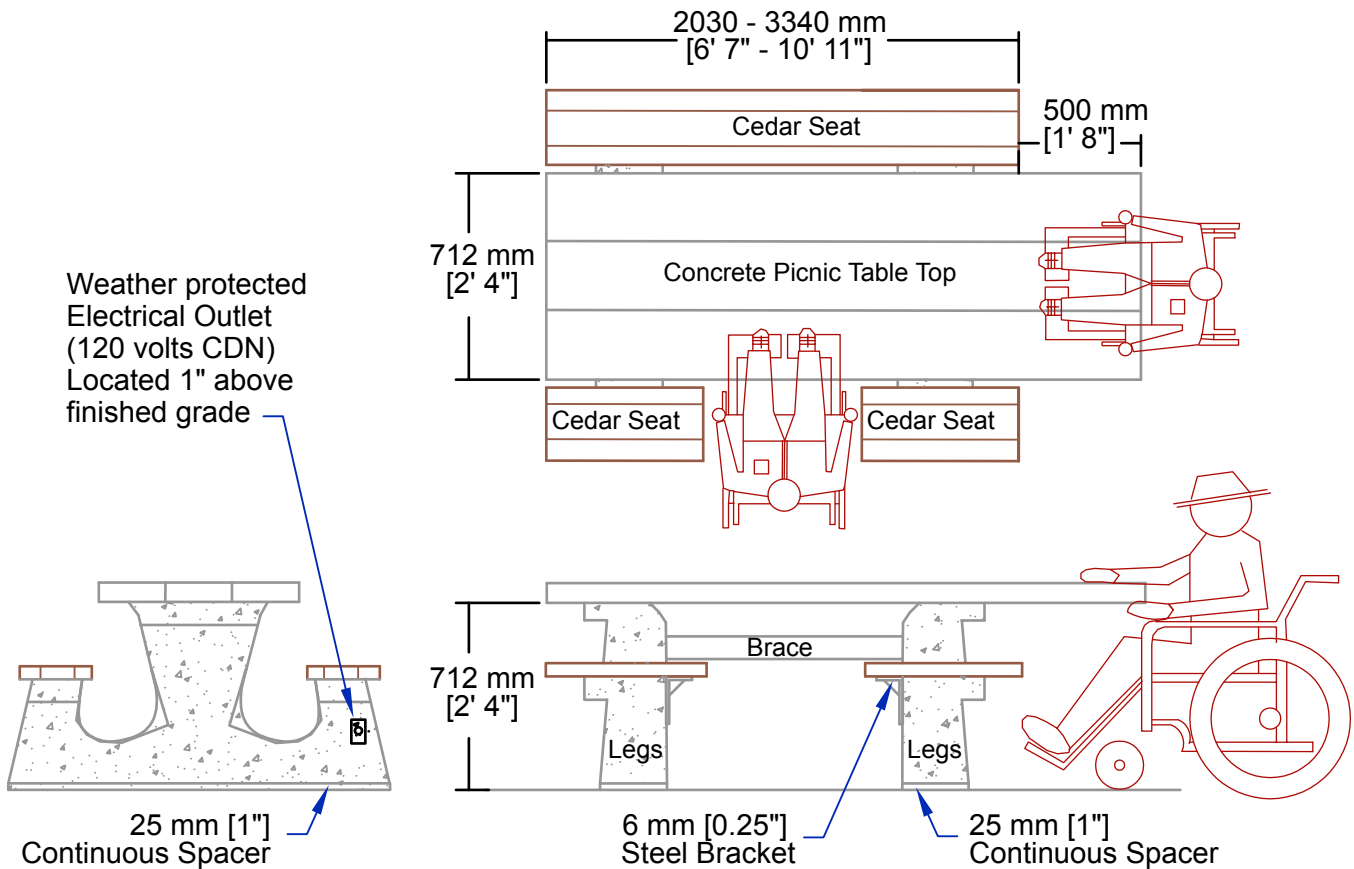

Accessible picnic table construction details:

- Exposed aggregate legs.
- Concrete or cedar slats (less splinters).
- All metal connections to be galvanized steel.
- 25 mm [1"] continuous spacer under concrete supports added to table platform for height to be appropriate to achieve 712 mm [28"] underside of table top height.

3.4 Park Services, Trail Signage & Campgrounds: 3.4.12 Accessible Campsites

- Accessible campsites should be situated in different locations throughout a site to provide a variety of choices and to take advantage of the area's natural features.
- Accessible campgrounds shall provide accessible facilities for shelter, transportation, recreation, information, and registration.
- At least two accessible campsites shall be provided within an accessible campground, and shall be integrated within the campground. It is recommended that 5% of the sites be accessible.
- Lantern hooks are very important for a person in a wheelchair as holding a lantern on your lap is not safe and holding a flashlight is cumbersome. Lantern hooks must be placed so that they do not create safety and fire hazards, do not protrude into paths, and are mounted at appropriate heights based on reach ranges.
- Grills on post-mounted stands should rotate to allow for changes in wind direction.
- Handles on fire rings and grills must be easy to grasp and not conduct heat.
- The surfacing around a fire ring or grill should be a base of well-compacted, crushed fine gravel and the use of native soil as a surfacing is not recommended. Campers will use the soil

to douse fires and hot embers, not realizing that the holes they leave behind will be safety and tripping hazards for future visitors to the site.

- If cooking facilities are provided, they shall be between 450 to 600 mm [1' 6" to 2'] high.
- The campsites that are accessible should be linked to the park facilities and other accessible campground features, such as play spaces and beaches, by accessible and universally designed trails.

Pathway – Fern Creek Campsite, Maple Ridge, B.C
photo credit: Donna Rodman



Shelter Area – Fern Creek Campsite, Maple Ridge, B.C. / photo credit: Donna Rodman



Complies
Achievable
Does Not Comply



Standard Guidelines for Accessible Campsites:

Figure: 3.19 – Accessible Campsites

p63 A, B, C, D, E, F, G

- A** Requirements for back-in accessible parking spurs at campsites require a minimum width of 4.8 m [15' 9"] and should be 15 m [49' 3"] long to accommodate recreational vehicles with wheelchair lifts and awnings.
- B** Water and utility hookups are important amenities at an accessible site, and they must be designed in accordance with accessibility guidelines to include clear ground space for manoeuvring, reach ranges, and levered hardware for operation of valves. Hookups should be located to the back of the driver's side of a back-up in parking spur.
- C** Accessible campsites shall have an accessible picnic table. Electrical service is recommended to the picnic table to allow scooter batteries to be plugged in for recharging or ventilators to be run while batteries are recharging. Failing this, a battery charging unit should be provided at each accessible campsite management office.
- D** A flat and stable tent pad area 6 x 5 m [19' 8" x 16' 5"] shall be provided. A raised tent pad is not required. While tent pads should be located adjacent to firm and stable surface areas so that campers can access them from campsite walkways, the tent pad itself cannot be hard surfaced. The selected material must provide positive drainage, be a firm, stable, and slip-resistant surface, and it should be comfortable and easy to pound in tent stakes.
- E** A clear area of 915 mm [3'] must be around elements of the accessible campsite such as the tent pad, fire pit, and picnic table. These spaces may overlap with the clear ground space required for the other elements. This allows circulation by a person using a chair or scooter between and around elements such as tables and cooking pits.
- F** All new fire rings and grills must meet accessibility requirements. To be safe, they should be located off the path and not in heavily travelled areas. For example, they should never be installed between parking (exit) or outdoor recreation access routes and the camping and seating areas for example. In addition, they should be installed downwind from camping and seating areas.
- G** Accessible campsites shall be located no further than 100 m [328'] from a washroom and an accessible source of water.

Figure: 3.19 – Accessible Campsites

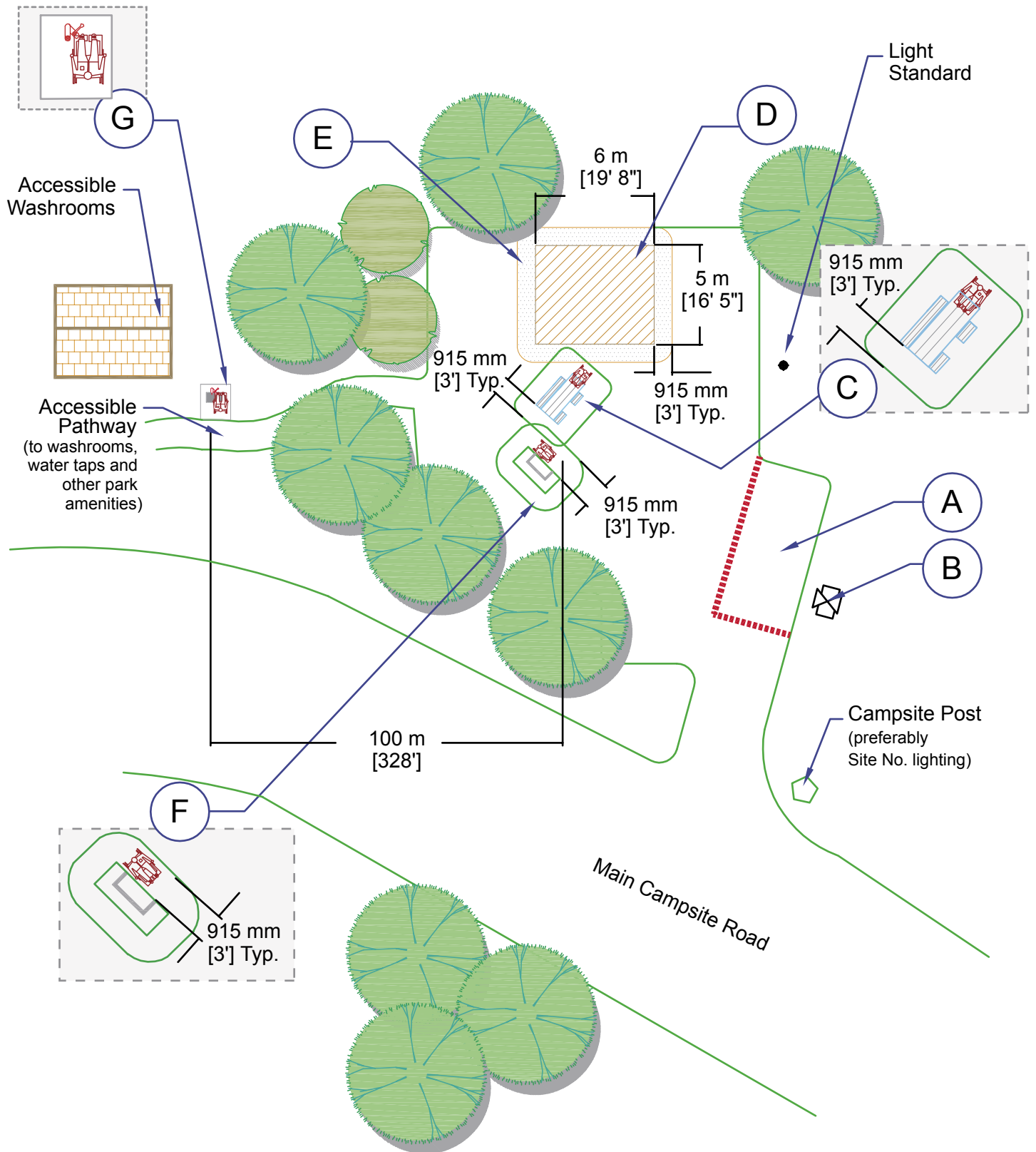

3.4 Park Services, Trail Signage & Campgrounds: 3.4.13 Walkways & Pathways

- Pathways from designated parking areas are to provide smooth and safe travel, without a change in level, between the parking area and the park entrance/exit or park facility. Refer to 3.2.1 *Parking Areas (Above, Underground & Trailhead Parking)* regarding the connecting of parking areas to accessible walkways and pathways.
- Surfaces must be firm. Asphalt is the preferred surface. Stone dust, fine limestone, or gravel screenings may be used because they compact to form a hard surface. The fines are placed on leveled and compacted gravel. The standard is to place 100 mm [4"] of fines on poorly drained soils or 50 mm [2"] on sandy soils. Sandy granular, sand, clear stone, wood chips, and native soil will not compact well and are unsuitable materials for a universal trail.
- A boardwalk must be built across damp and soft areas that form part of an accessible walkway or pathway in natural settings to ensure people using wheelchairs and wheeled mobility aids do not get stuck in the mud. Typically, people using wheelchairs use gloves on their hands to turn their wheels but it is not so pleasant having to operate a chair with wet and muddy hands.
- Gratings located in pedestrian areas shall have openings not greater than 13 mm [0.5"] wide in one direction and be placed so that the long dimension of the opening is perpendicular to the primary direction of travel. This is designed so that the front wheels of wheelchairs cannot drop into the longitudinal holes in the direction of travel. It is preferable that gratings not be located in the accessible route.
- The walkway should be crowned at the centre with no greater than a 2% slope laterally at any point for drainage.
- A width of 1800 mm [6'] is preferred so that a person in a wheelchair can have a person ambulating beside them as a companion. The minimum width of a route even at its narrowest points must be 1200 mm [3' 11"].
- Resting intervals are required along a walkway, and if it is possible, to provide an accessible bench or seating area.
- Where the ground drops steeply away from the edge of the pathway, provide a wooden curb and a handrail.
- In natural settings it is recommended that the edge of a pathway be lined by colour contrasted material to a width of 350 mm [14"] on either side using a light rock, crushed limestone, or wood chips. Alternatively, a wood curb that is 50 mm [2"] high that can be used as a tapping rail. These measures help mark the pathway for people who are visually impaired. The curbing also helps to keep wheelchair wheels out of the edges of the pathway where the soil may be wet or soft and helps contain the gravel fines and therefore the integrity of the pathway surfacing.
- In rural/urban settings, a walkway that is accessible should also be clear of branches, debris and other obstructions to a total width of 1200 to 2400 mm [3' 11" to 7' 10"] on either side, and a total height of 2400 mm [7' 10"].

*Trail – Spirea Trail Entrance, Golden Ears Park, Maple Ridge
photo credit: Natasha MacArthur*



3.4 Park Services, Trail Signage & Campgrounds: 3.4.14 Trail Signage

Trail Signage – Golden Ears Park, Maple Ridge, B.C. / photo credit: Natasha MacArthur



- If a park facility is accessible, it should be signed as such. If a trail is accessible it should have the Universal Design trail difficulty rating system applied.
- Interpretive displays, signs, and related materials should be installed at site entrances, along trails, and in visitors' centres. The paths that lead to the signs and displays must meet the level of accessibility that is consistent with the recreational setting.
- It is desirable but not always possible to have the accessible parking spots close to trailhead areas where trail signage is posted.
- Data on trail attributes and features should be posted at information areas and trailheads, and provided in trail guides, maps, and brochures. This information can include trail profiles, water crossings, and significant topographic features which lead to narrow trails and cliffs.
- Maps should identify the locations of narrow trail widths (minimum values) and the maximum value of grades and cross slopes. If a trail loop is provided and maps are located at the mid-point of the loop, users with limited mobility and endurance can choose the direction they wish to continue to travel around the loop.
- A map of trail systems should also provide information on whether there is an accessible bus stop near the trailhead, accessible washrooms, and an accessible phone.
- Having fluorescent signage is very useful for walking at night and is recommended to be applied to signage that follows roadways in campsites to comfort stations.
- Signs for doors are to be located on the wall to the right of the door, and consistently mounted at 1350 mm [4' 5"] above the floor and not more than 150mm [6"] from the door jamb.
- The requirement for signs for restrooms varies by the nature of the setting. Urban/rural settings will have wheelchair pictograms or generic shapes such as a circle for a washroom for females and triangle for a washroom for males. The text should be raised and have a Grade 2 Braille. In roaded, natural settings, Braille is optional.
- Audio signs, talking signs, and captioned material are available on the market and provide audio sound, audio text, or visual material with signed caption interpretation. These are recommended when display cases or interpretative information is to be conveyed to the park visitor. Narrative presentations, audio text, or captioned material in video for the people with hearing impairments, enhances the visitors' experience. With the new technologies today, it is also possible to have translated options in various languages for international visitors.

Complies
Achievable
Does Not Comply



Standard Guidelines for Trail Signage:

Figure: 3.20 – Trail Signage

p67 A,B,C,D, E, F, G, H, I, J

- A** All signage should be facing the path of travel and mounted to a height between 1200 mm [3' 11"] and 1700 mm [5' 107"] above grade.
- B** The primary trailhead signage area should be adjacent to the path of travel but offset such that an area of 1800 mm [5' 11"] depth x 2640 mm [8' 8"] width is available in front of the sign board and on a level and firm surface with positive grading at 2% for drainage of water to perimeter edge. Cross-slopes may be necessary to achieve this, however, directing the slope of the pad toward the accessible trail or pathway is required. The area will allow people to gather at the sign board and it allows people using scooters to make U-turns.
- C** The interpretive trail signage should be aligned adjacent to the path of travel and offset from the main trail. If there are space constraints, the space requirements in front of the interpretive signage can be at the minimum of 1500 x 1500 mm [4' 11" x 4' 11"].
- D** Stylized signage should be avoided and the Parks Department should set a uniform standard for signage, signage lettering, and colouring for consistency throughout each outdoor public setting.
- E** Arabic numerals and Sans-Serif letters should be used, with high contrast between the characters/symbols and the background colour of the sign.
- F** Primary trail head signs should be located in well-lit areas, and glare free surfaces should be used.
- G** To assist people with visual impairments, it is recommended to use tactile signs with raised lettering for urban/rural trail systems and roaded natural settings where reasonable. Characters should be raised 0.8 mm [0.03"] and be between 16 mm [0.63"] and 50 mm [2"] in height. Characters shall have a width-to-height ratio between 3:5 and 1:1, and a stroke-width-to-height ratio between 1:5 and 1:10. If larger print height is required, consult with the signage department in City Hall to obtain information relating to print size, legibility, and viewing distances.
- H** If a display case is put on the site, it should be at a comfortable height and/or at an angle that a child can peer in. A mounting height of 600 to 750 mm [2' to 2' 5"] is ideal. Care must be taken to include a 30 to 45 degree inclination toward a viewer if the display is to be viewed from a sitting position. This degree of inclination is accessible to most visitors.
- I** Interpretative signage mounted at 600 to 750 mm [2' to 2' 5"] allows most park visitors to read information provided. Pictures and graphics are legible to everyone.
- J** Lighting should be selected and positioned to reduce glare and reflections from as many possible viewing angles.

Figure: 3.20 – Trail Signage

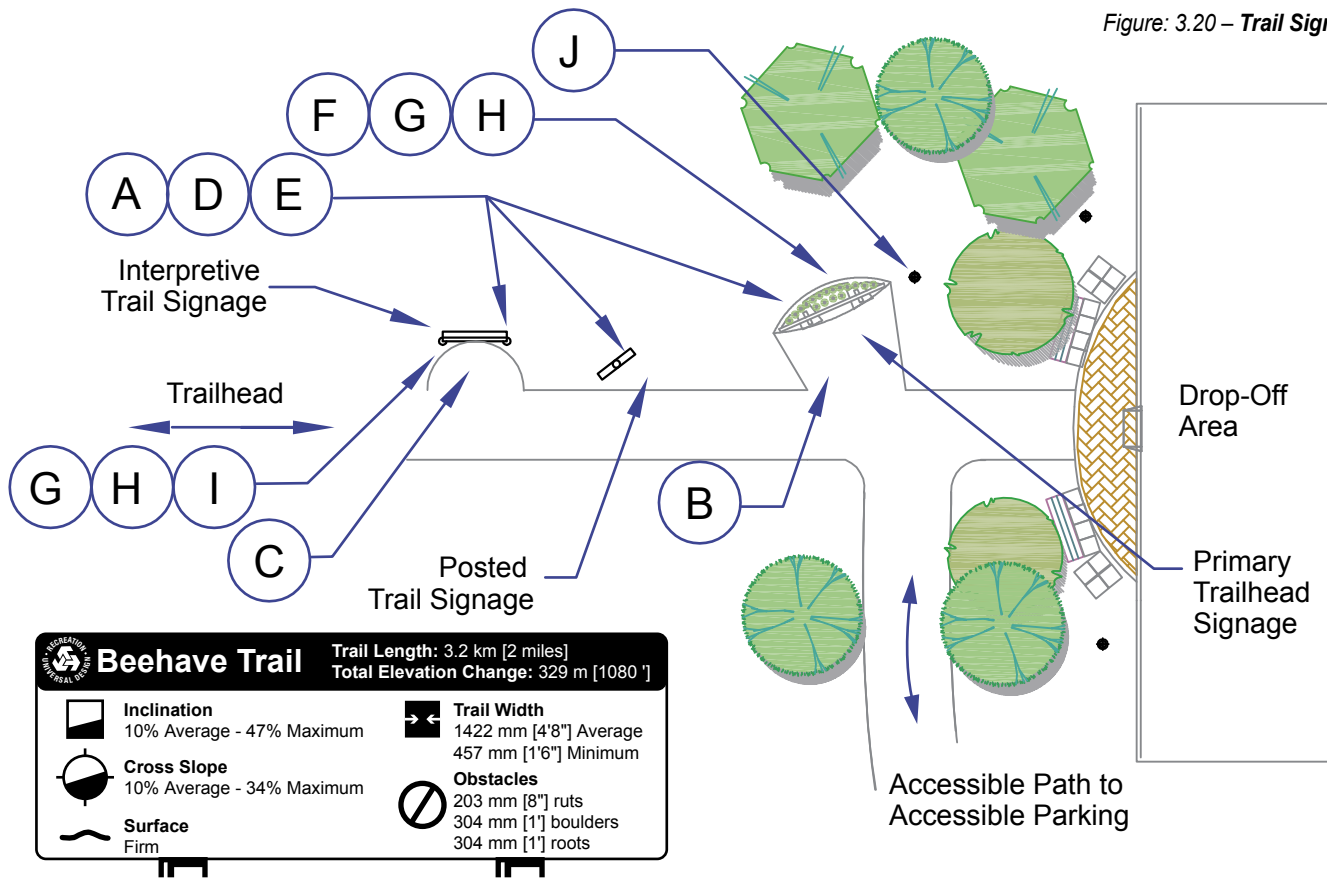

Trail Difficulty Rating:

- Signs along trails must clearly inform users of site conditions related to accessibility. The advantage of using Universal Design Symbols instead of the International Symbol for Accessibility is the explicit way in which the level of accessibility for each trail is conveyed.
- The rating system allows an individual to choose which trail to use based on their ability and interests. The key is to provide accurate and complete information on trail conditions and characteristics of the site. The four basic requirements are grade, cross-slope, width, and surface.
- Because different groups with varying abilities use trails, it is reasonable and satisfactory to categorize trails based on the level of difficulty. Use additional qualitative measures such as trail length, slope averages and maximums, cross slope averages, width of trail, trail surface, boardwalks, and stair systems. The scale is determined from collecting averages of minimum and maximum values along the

trail. If a trail profile is provided, the users can access where they may choose to turn back. Specific obstacles such as vertical obstructions, water crossings, and drop-offs should also be identified where possible.

- Seasonal factors can play a part in the trail difficulty rating and need to be indicated on the trailhead signage boards. These factors would also include avalanche and fire hazard postings that are legible and accessible to all users.
- The trail difficulty rating system was developed by *Beneficial Designs Inc. in California, the U.S. Forest Service, and the National Parks Service*. The symbols are derived from those used to mark the degree of difficulty for downhill skiing of our ski hills in Canada.



3.4 Park Services, Trail Signage & Campgrounds: 3.4.15 Boardwalks (over water)

- Boardwalks are provided when topography is broken or rough; the ground is wet or soft; and a viewing area or platform is desired over a river bank, lake, or wetland.
- Boardwalks are typically reviewed by environmental management to conform to setback requirements particularly with respect to environmentally sensitive areas, wetlands, and fish habitats.
- Boardwalks in recreation settings are predominately made of wood decking. Slip resistance refers to the frictional force necessary to keep a shoe heel or crutch tip from slipping on the walking surface. It is a complicated force, a variable static coefficient, and its application in terminology is various in practice. Wood is not slip-resistant when wet.
- Planks must be securely fastened and treated with appropriate preservatives for the environmental condition of the site to avoid decay and drying.
- Treatment is a maintenance versus habitat disturbance issue. The intent is a minimal amount of habitat disturbance in the long run and for the life of the boardwalk.
- Boardwalks can be planned for so that predominately they are on-grade to the adjacent ecologically sensitive habitat.
- Regularity and predictability of the boardwalk will aid the person with visual impairments or a senior wayfinding along a boardwalk. Avoid sharp turns, particularly on grades that are downhill. Clear lines of sight are needed for both increasing a sense of security and sightlines down the body of water or across a marsh/savannah.
- Signage should be provided at the start of the boardwalk entry for everyone to pack out what they pack in including their garbage. The signage should also cover people picking up after the dog while walking on the boardwalk as this can cause slipping on the wooden deck.
- Maintenance of the boardwalk would include cleaning off bird droppings, wet leaves, and tree debris that may fall onto the walkway.

Boardwalk – Deer Lake, Burnaby, B.C. / photo credit: Donna Rodman



Boardwalk – Golden Ears Park, Maple Ridge, B.C. photo credit: Natasha MacArthur



Complies
Achievable
Does Not Comply



Standard Guidelines for Boardwalks:

Figure: 3.21 – Boardwalk Plan View p69 A, C, F
 Figure: 3.22 – Boardwalk raised less than 600 mm over water p70 A, B, C, E
 Figure: 3.23 – Boardwalk raised greater than 600 mm over water p70 A, B, C, D

- A** Planks must run perpendicular to the direction of travel and joints must be no more than 13 mm [0.5"]. Typically due to wood shrinkage, it is better to construct the decking with joints no larger than 6 mm [0.25"] to allow for shrinkage of the wood so that in the end, the gap is no larger than 13 mm [0.5"].
- B** Grades are not to exceed 5% and shall be smooth and level.
- C** Boardwalks shall have kick rails or edge curbs created by a raised barrier or rail with its lower edge not more than 75 mm [3"] from the boardwalk surface. The height of the curb is to be 102 mm [4"] maximum.
- D** A raised boardwalk should have a railing as a guardrail 920 mm [3'] high, with a top rail, middle rail, and bottom rail. This applies to a boardwalk that is raised over 600 mm [2'] above grade or crosses water.
- E** Herein there is debate about guard rails and it is up to the discretion of the designer, the District, and the City as to whether a guard rail is required if the boardwalk height is under the 600 mm [2'] above grade or crossing water dimension.
- F** If viewing areas are provided with benches, the benches are to be recessed from the accessible route of travel and an increase in width of the boardwalk is required to at least 2400 mm [7' 10"] to allow for benches and people using wheelchairs on the viewing platform. Benches are to be anchored and have arm and back rests.

Figure: 3.21 – Boardwalk Plan View

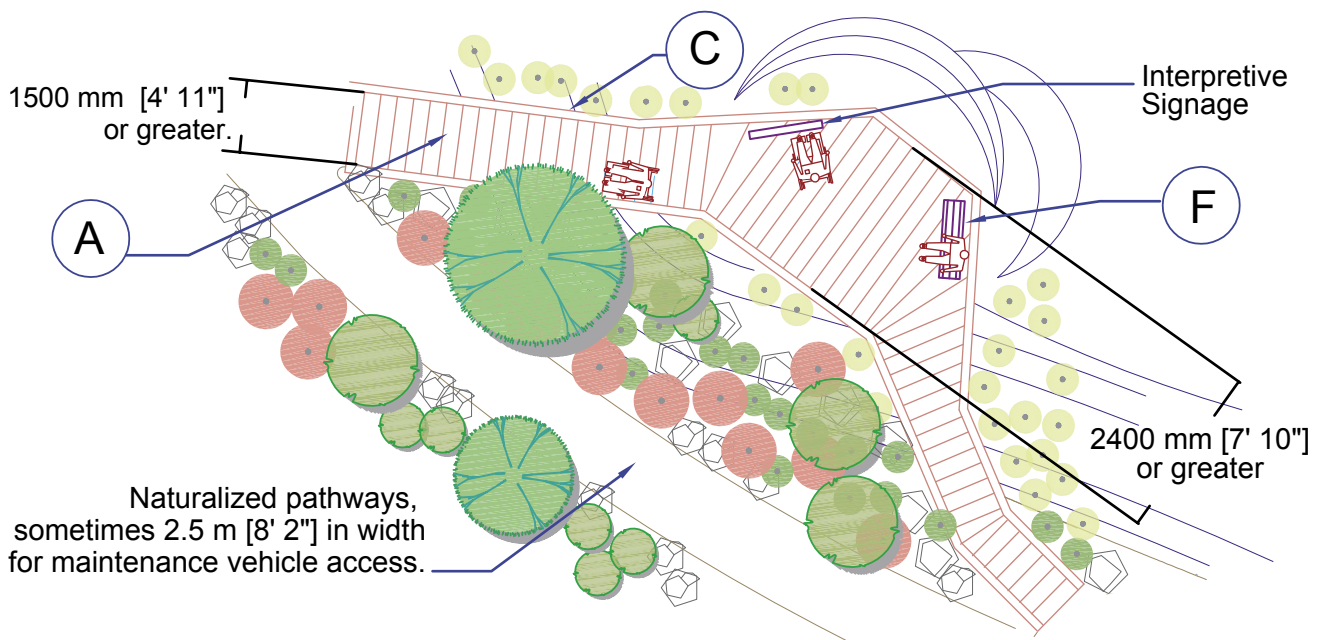

Figure 3.22 – Boardwalk raised less than 600 mm over water

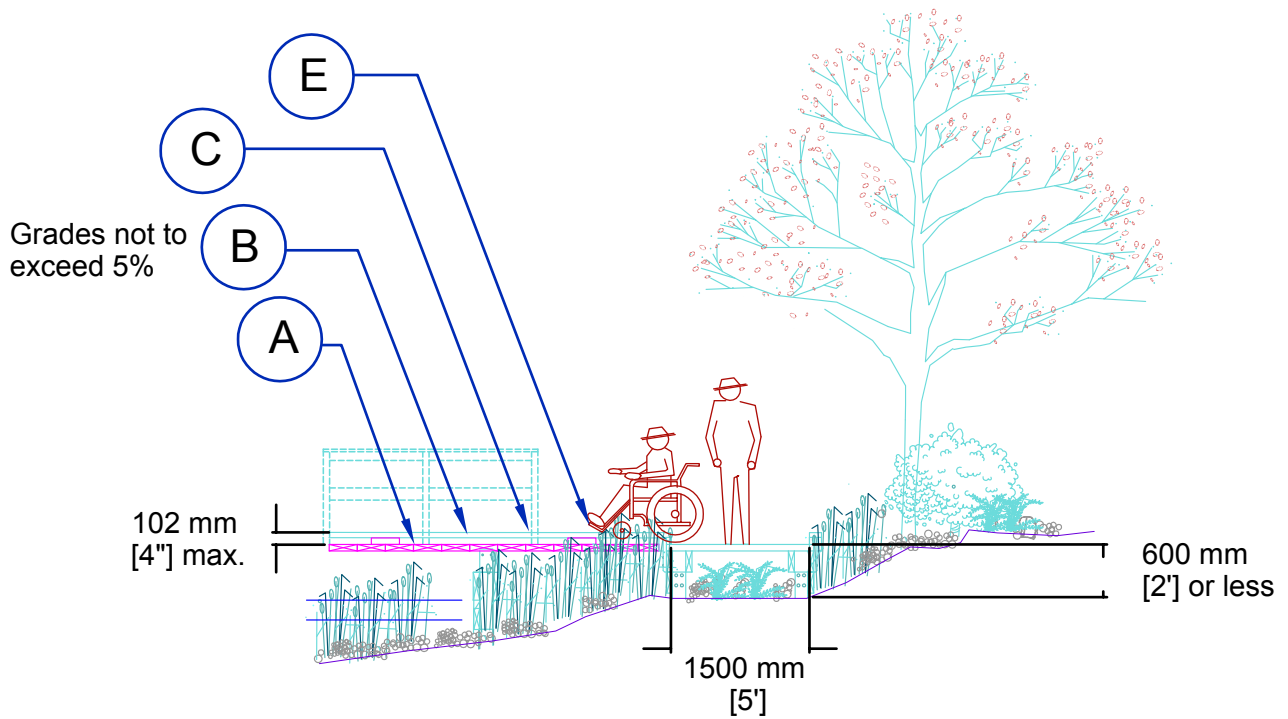
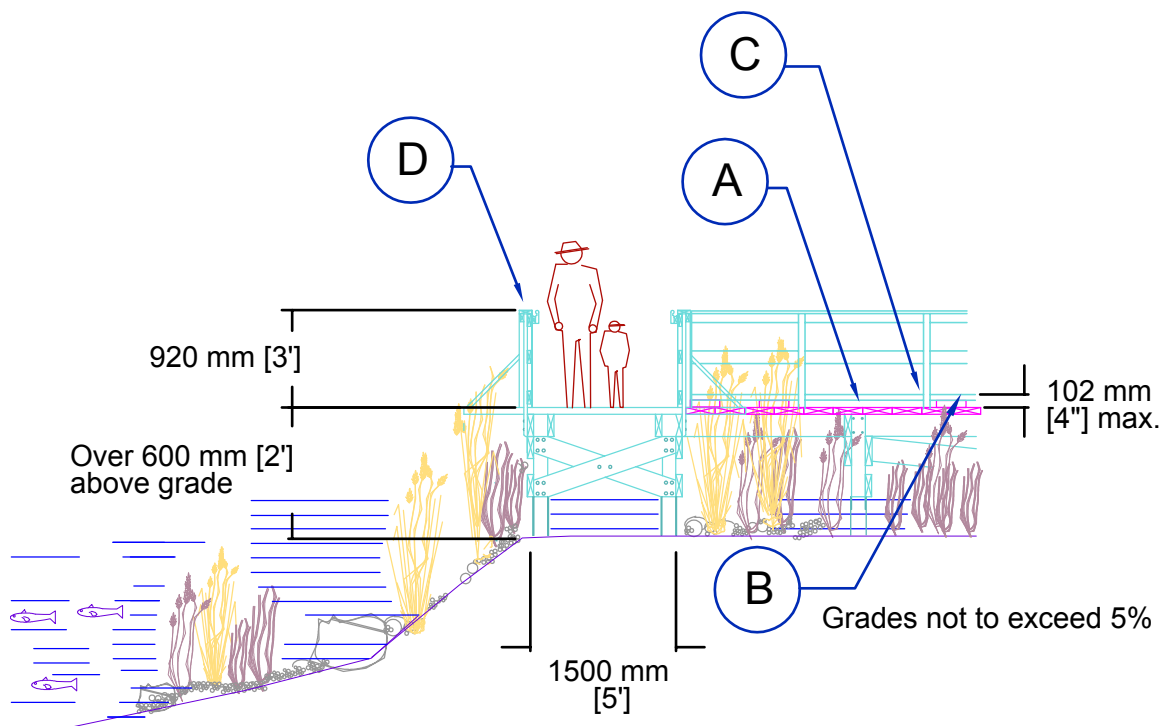

Figure 3.23 – Boardwalk raised greater than 600 mm over water



3.4 Park Services, Trail Signage & Campgrounds: 3.4.16 Fishing Platforms

- Site managers, planners, and park designers need to examine the characteristics of a recreational site before deciding to make the fishing docks accessible. One part of that decision making process involves environment management determining the capacity of the fishing site based on scale of the body of water and a typical day's fishing demand. As well, each person fishing has special *secret spots* but to create an integrated fishing experience, the accessible fishing facilities should be interspersed within the existing pattern of fishing spots so that desirable fishing locations are available to all anglers.
- Modification to streambanks and shorelines to improve access are primarily found in urban/rural and roaded natural settings. The more primitive settings cannot practically be considered for designing interventions.
- Typically modifying or constructing a fishing dock facility where anglers can expect safe and easy accessibility is doable. An accessible route shall lead from accessible parking and

accessible washrooms shall be available. A universally designed washroom would allow the facility to be used by both men and women and one regularly maintained unit would suffice for this type of recreational site.

*Fishing Platform – Tour of Providence, Rhode Island
photo credit: Donna Rodman*



Complies
Achievable
Does Not Comply



Standard Guidelines for Fishing Stations on Dock Facilities:

Figure 3.24 – Fishing Dock Elevation View
Figure 3.25 – Fishing Dock Plan View

p73
p73

A, E, F, H
B, C, D, G

- A** Fishing station is to be firm and stable (not on a floating dock), have a slip-resistant surface, and a maximum slope for positive drainage of 2% in any direction.
- B** Tactile warning strips and directional tactile strips are to be judiciously placed between the surface of the fishing station and the surface of the adjacent accessible route to assist a person with visual impairments to access the station.
- C** Provide a minimum of 1525 mm [5'] per angler or 3660 mm [12'] for 2 anglers (PLAE, Inc. 1993).
- D** Provide 2440 to 3650 mm [8' to 12'] of clear space behind anglers to allow for the angling throw and to allow for pedestrian circulation behind the anglers. A consideration is to place the accessible fishing station at an end of the fishing dock facility to give an extra degree of safety for pedestrians simply coming to view from the dock.
- E** There are great debates about the use of safety rails, guard rails, and barriers on docks. Safety rails must always be provided at the water's edge where fishing as a recreational activity is occurring. Technically, safety rails are to be provided at all drop-offs where water is at the edge. This item requires consultation with users of the fishing facility and if it is decided that the safety rails are not to be used on other parts of the dock system, then signage to that effect and the conditions of hazard and liability should be clearly posted at the fishing dock facility. However, for the fishing station itself, the safety rails, with augmented design, can serve many purposes for the angler with a physical disability including acting as arm rests, locations for tackle box shelves, and fishing rod holders (for hands-free fishing).
- F** Curbs at drop-offs on docks must be provided to notify people of the edge of the dock and to act as wheel stops and they are to be 102 mm [4"] high at the platform edge. These curbs are not like the curbs used to protect users from the edges of ramps and usually allow for spacing under to pull a rope through for mooring a canoe or kayak.
- G** Seating, if provided for friends and family, should be located on or adjacent to the fishing station. The seating should not intrude upon the required clearances for the fishing station or accessible routes.
- H** Shade and shelter is often hard to provide at fishing stations. Constructing a shade structure interferes with angling. If there is natural shade and shelter, this is an added attraction. Vegetation or structures for shade should not reduce the vertical clearance to less than 3660 mm [12'] above the fishing station (required for casting) or less than 2030 mm [6' 7"] above an accessible route to the fishing station. (PLAE, Inc. 1993)

Figure 3.24 – Fishing Dock Elevation View

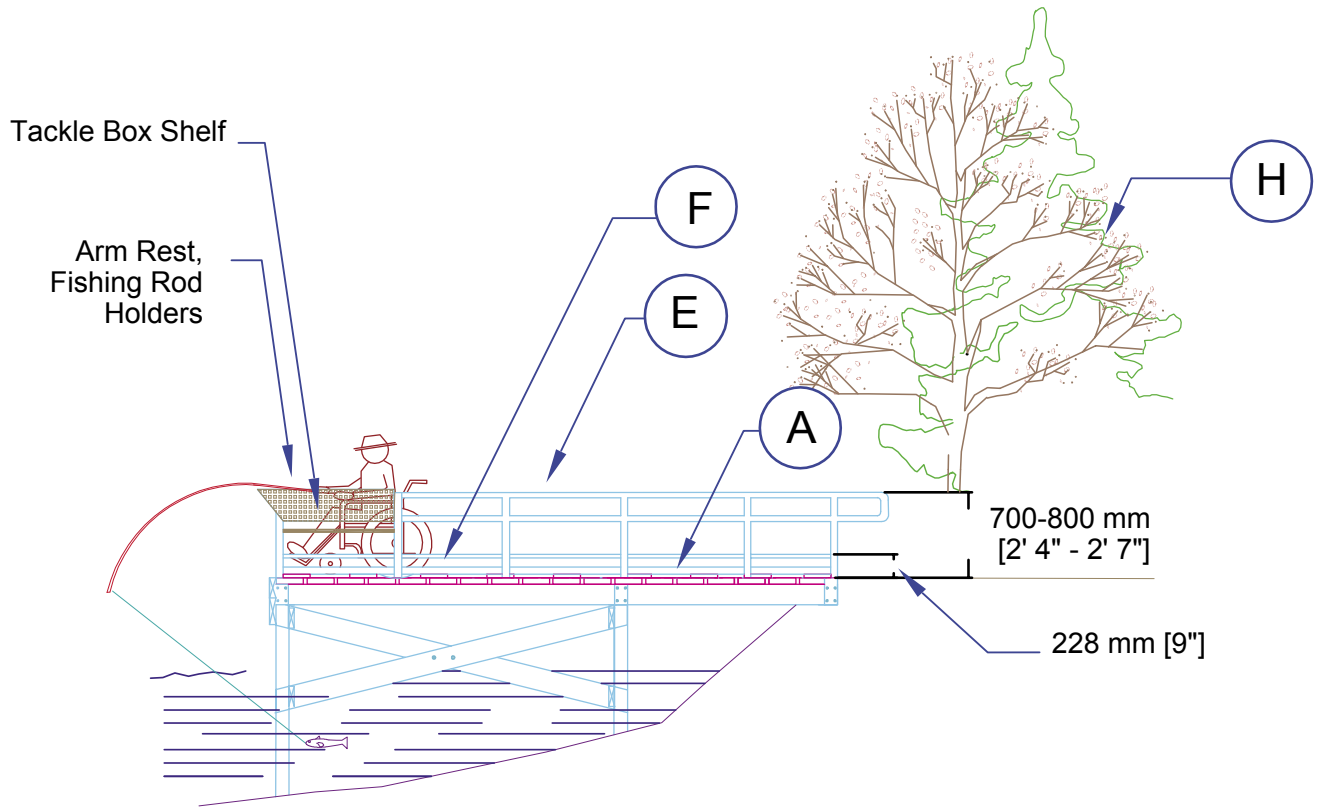
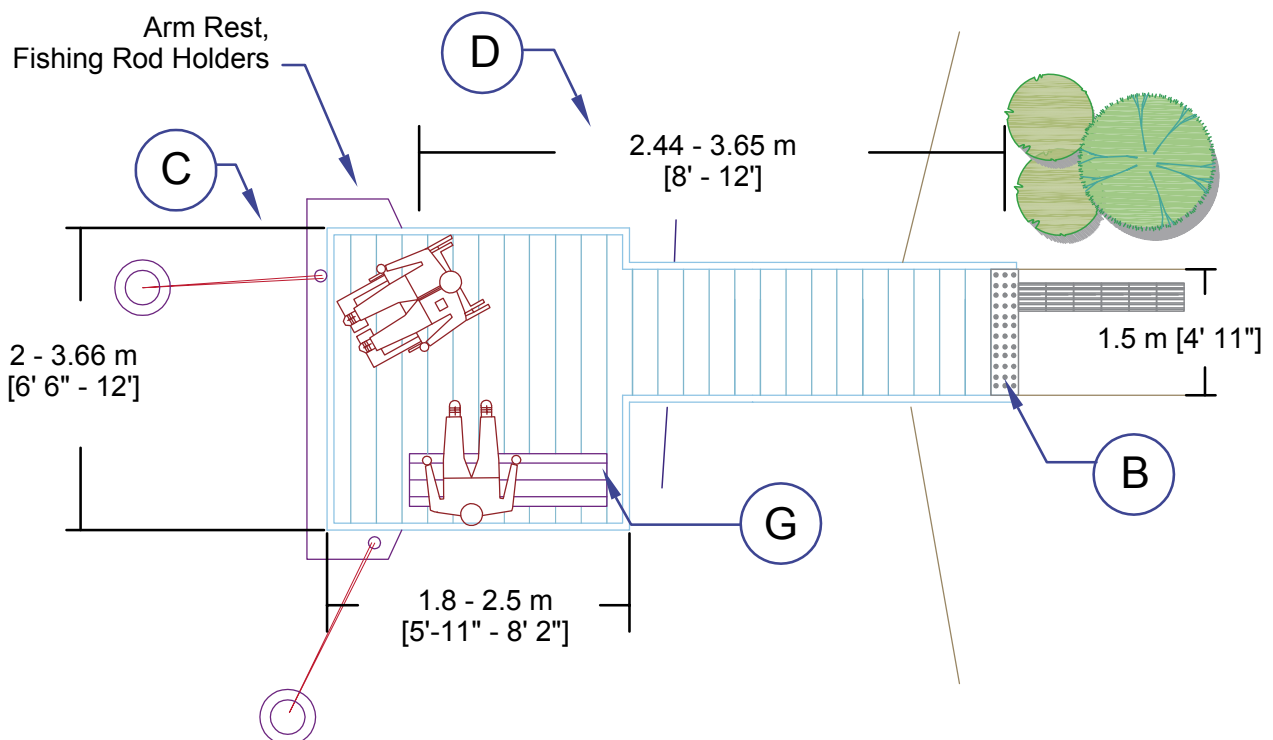

Figure 3.25 – Fishing Dock Plan View



3.4 Park Services, Trail Signage & Campgrounds: 3.4.16 Fishing Platforms

- Fishing stations in natural settings can adapt conditions of the guidelines for fishing stations on Dock Facilities. All of the items of A to D for dock facilities apply as to space requirements.

Complies
Achievable
Does Not Comply

✓

Standard Guidelines for Fishing Stations in Natural Settings:

Figure 3.26 – Fishing Dock Elevation

p74

A, B, C

- A** Safety rails and barriers for drop-offs are not practical nor sustainable in natural settings and would destroy the rustic nature of the fishing experience. Using flat, table top boulders and logs will provide an alternate to safety rails and drop-off curbs.
- B** As long as the users and their companions are fishing, the seating arrangements must be flexible yet safe. Space clearances for casting will have to be determined by the users of the space.
- C** Fishing stations in natural settings should be located to take advantage of natural shade and shelter. If shade vegetation is required, then designers can specify shade vegetation pursuant to the Ministry of Environment or Fisheries and Oceans Canada plant selection and implement the vertical clearances by selecting specific tree species with canopies and growth that will provide those clearances and also give shade.

Figure 3.26 – Fishing Dock Elevation

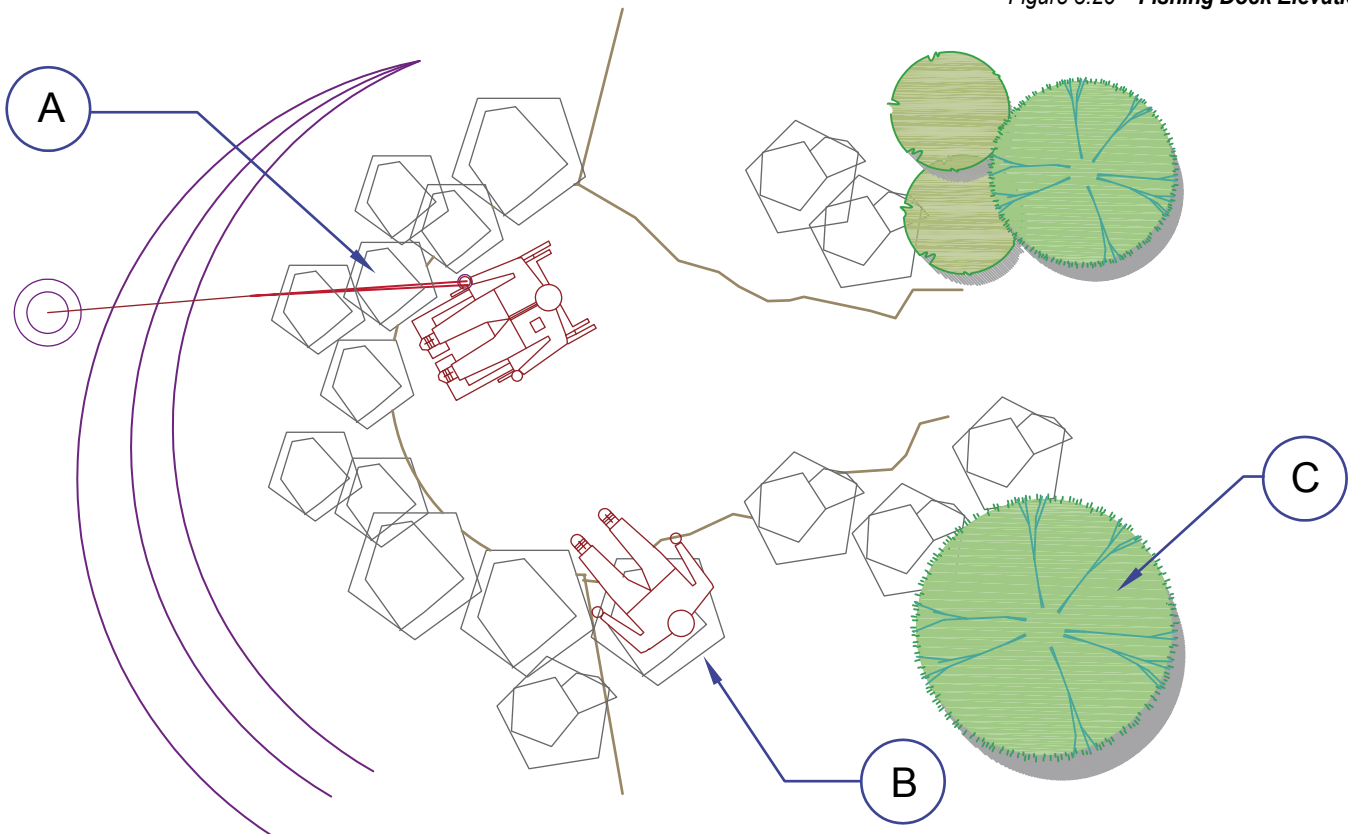

3.4 Park Services, Trail Signage & Campgrounds: 3.4.17 Beaches

- Beach mats that can be used for traversing over a sandy surface are available. The mats are portable and simply roll out over the sand so that a person in a wheelchair can cross a beach area.
- Typically, access to beach environments is provided by a hard-surfaced walkway that is a minimum of 1525 mm [5'] in width. Unfortunately, there is usually sufficient wind and water action around the edges of the walkway that create drop-offs from the walkway through erosion, thus undermining the intended purpose of access to the beach. The walkways also define the space where a person may access the beach using a wheelchair unless the chair is modified with special tires for traversing sand.
- Parking areas are to be located as close as possible to the beach areas with accessible stalls and drop-offs.
- Provide an accessible, expanded seating and gathering space, as close as possible to the water's edge.
- Provide shaded accessible seating areas at beaches.
- Provide accessible washrooms and changing facilities. The dimensional space for changing facilities is 2100 x 2100 mm [6' 10" x 6' 10"] and is a cubicle space that can be used also by families with small children.
- Where conditions permit, consider providing accessible ramps, stairs, and platforms in the water to allow a person who is disabled (with attendant) to enter the water. This requires handrails on ramps and platforms which are designed specifically for this purpose. One of the requirements is that at the bottom (water end) of the ramp, the top handrail must end at water level, extending 300 mm [12"] parallel to the water surface. The handrail may not end abruptly but must return to a wall surface, post, or ground, or they must be rounded.
(*Bunin et al, 1980*)

Accessible Change Rooms – *Tour of Providence, Rhode Island / photo credit: Donna Rodman*



- For stairs to be designed that lead into water, specific requirements are to be met including the width which is 915 mm [3'], treads must be 280 mm [18"], and risers at least 102 mm [4"] high, but not higher than 153 mm [6"]. (*Reis, M. University of Wisconsin, 1991*).
- For the handrail on stairs entering water, the same criteria that is noted above for ramps and platforms applies.

Beach Access Ramp – *Rocky Point, Port Moody, B.C. photo credit: Petra Frederick*



3.4 Park Services, Trail Signage & Campgrounds: 3.4.18 Outdoor Pool Decks

- Accessibility and safety is the central focus in the design of swimming areas if all participants are to fully participate. The liability issues are significant. Supervision is critical. Facilities specifically designed with hoists and slings, and that have experienced personnel on hand to assist with loading and lowering a person from a pool deck into a pool, are recommended.
- Stair systems into pools provide a valuable alternative access if a ramp or a hoist is not feasible. There have been many design programs created for pool entries using steps. Handrails are a must on both sides of the steps. The steps are to be situated outside of the main swimming area for reasons of safety and reduced water disturbance for a person entering the pool. Descent into a pool takes place at the shallow end and can be achieved by dropping down from the pool edge, using steps equipped with handrails, travelling down a slide or ramp, or using a pool hoist.
- The depths of the pool must be clearly marked.
- It is extremely important that the surfacing material around swimming pools be very slip-resistant, yet nonabrasive, and absorb a minimal amount of heat when exposed to sunlight.
- The recommended pool depth for a person with a disability is 1 to 1.2 m [3' 3" to 3' 11"] at the shallow end and approximately 1.8 m [5' 10"] at the deep end.
- Water jets and sound signals which indicate turning points before the end wall of a pool, can be provided for the person swimming with a visual impairment.
- In order to help with depth perception, the edge of a pool must be marked with contrasting colours and materials. The possibility of applying a tactile warning pattern, such as that used for sidewalk curb ramps, is recommended for people with visual impairments. The directional tactile pattern could be applied to one side of a pool deck leading from the change rooms to the shallow end and terminating with the tactile warning pattern set back 152 to 300 mm [6" to 12"] from the edge of the pool.

Stairs & Ramps – 2nd Beach, Stanley Park, Vancouver, B.C. / photo credit: Donna Rodman



- Handrails must be present for people with disabilities to enter the pool water and they must be built within the depth of the pool wall. Handrails must not project at any point from the line of the pool edge. Handrails must be situated at 50 to 100 mm [2" to 4"] below water level and be 30 to 50 mm [1.25" to 2"] in diameter to be graspable.
- If there is a foot wash basin around the edge of a pool, a bridge is required so that a person in a wheelchair can cross the basin.
- A handrail could run for the entire length of the pool or for at least one long and one short side.

Conclusions

Because technologies change quickly and individual abilities vary so greatly, designers and planners of outdoor open spaces can no longer make assumptions of who will be able to get to and enjoy a particular recreational or outdoor site. To create universal access in outdoor and open spaces, the planner and designer can work through the Universal Design concepts and principles in four steps:

1. **Survey and needs analysis for Universal Design**
2. **Design and field inspection**
3. **Verification by users**
4. **Implementing feedback**

The first step is to heighten people's awareness of the need for Universal Design and to incorporate the Universal Design concept and principles in the design process. Then a user opinion survey is conducted to identify needs and to obtain comments from users.

The second step is to add design considerations for requested items found in the survey to the accumulated design data, and to propose the most appropriate and best-suited design for the site. Aesthetic value is very important at this stage. In the construction stage, the design intent needs to reflect utmost care in details.

The third step requires participation of prospective users, for a trial use to check that the completed work is usable by people with different levels of ability.

Based on the results of the verification, **the fourth step** involves addition to and modification of the completed work and research data. When incorporating Universal Design principles in landscape design, it is very important to repeat these steps in order to attain the greatest extent of usability for diverse user groups.

While not the rule in landscape architecture and urban planning, traditional architectural praxis has often assumed that form making is an autonomous act that is divorced from social responsibility, civic engagement, and environmental stewardship. Universal Design seeks to resolve the dichotomy of design as a formal art versus design as a social art by embracing creative work that is dedicated to both – creating welcoming, safe, sustainable and beautiful environments that can be enjoyed equitably within a just society that addresses human and environmental concerns. It does foster ethical design as we affect the lives of others by our decisions. If we are to design a society in which all people and all living things matter, we will have to move beyond the politics of human and environmental exploitation that defined the twentieth century. By working with Universal Design guidelines, and by recognizing the interdependence we have with each other and, our natural environment, we can think, act, and design out of recognition, awareness, and understanding to improve everyone's quality of life.

Bibliography

BC Transit Municipal Systems Program: *BUS STOP: Design Guidelines for Accessible Bus Stops.*

Bentzen, B.L., Barlow, J., Tabor, L. (2000). *Detectable Warnings: Synthesis of U.S. and International Practice.* U.S. Access Board, Washington, D.C.

British Columbia Building Code 2006, Building Policy Section, Ministry of Municipal Affairs.

Bunin, N., Jasperse, D. and Cooper, S. (1980). *A Guide to Designing Accessible Outdoor Recreation Facilities.* Washington, DC: USDI Heritage Conservation and Recreation Service (Lake Central Regional Office, Ann Arbor, MI).

Canadian Standards Association (2003). *CAN/CSA – Z614-03 Children’s Playspaces and Equipment. Updates have occurred – August 2004.* CSA, Mississauga.

Canadian Standards Association (2004). *B651-04 Accessible Design for the Built Environment.* CSA, Mississauga.

Department of Justice, Code of Federal Regulations. (1994). 28 CFR Part 36: *ADA Standard for Accessible Design*

Environment Canada Parks Service. (1991). *Access Series: Accessibility: Requirements and Recommendations, Minister of the Environment, Minister of Supply and Services.*

Harris, C., and Dines, N. (1998). *Time-Saver Standards for Landscape Architecture: Design and Construction Data.* McGraw-Hill.

Institute of Medicine. (1991). *Disability in America: Toward a National Agenda for Prevention; Summary and Recommendations.* Andrew Pope and Alvin Tarlov, editors. Washington, DC: National Academy Press.

Roiko, H., Graf, G., Hohenester, G., Linhart, Ann-Mary, (2000). *Taktile Bodeninformationen, Magistrat Graz Stadtbaudirektion/StraBen- und Bruckenbauamt, Graz, Austria.*

PLAE, Inc., (1993). *A Design Guide: Universal Access to Outdoor Recreation.* Berkeley, California, PLAE, Inc.

Reis, Michael L. 1991. *Design Standards to Accommodate People with Disabilities in Park and Open Space Design.* University of Wisconsin – Extension.

Ringaert, L., Rapson, D., Qui, J., Cooper, J., and Shwedyk, E. (2001). *Determination of New Dimensions for Universal Design Codes and Standards with Consideration of Powered Wheelchair and Scooter Users.* Winnipeg: Universal Design Institute (Faculty of Architecture, University of Manitoba).

Rodman, D., (1997). *Wayfinding Kiosk Systems: Issues and Criteria.* Paper Published in Proceedings for the Canadian Society of Landscape Architects: High Tech High Touch, CSLA/AAPC Congress 97, Edmonton.

Rodman, D. (1999). *Our Children in the Landscape: The Universal Play Space.* MLA Thesis Completed for The Faculty of Graduate Studies, The Faculty of Agricultural Sciences. The University of British Columbia, 1999.

The Master Municipal Construction Documents Association. (2000). *Master Municipal Construction Document, Volume II, Instructions to Tenderers – Part II.*

Verhe, Irma, (1995). *Outdoor Recreation for Everyone: The Adaptation of Outdoor Activity Areas for the Use of the Disabled.* The Finnish Association for the Disabled. Supported by: The Ministry of Education and the Ministry of Environment, Finland.

Wilson, Keith. (1991). *Handbook for the Design of Barrier-Free Recreational Boating and Fishing Facilities.* Washington, D.C: States Organization for Boating Access.

Glossary of Terminology

The booklet has abbreviated terms and anachronisms which are defined below.

MACAI	District of Maple Ridge and the City of Pitt Meadows Municipal Advisory Committee on Accessibility Issues
FAIA	Fellow of the American Institute of Architects
ANSI	American National Standards Institute
ADA	Americans with Disabilities Act (Year: 1990) – ADA Standards for Accessible Design
CSA	Canadian Standards Association
MMCD	The Master Municipal Construction Documents Association. (2000) Master Municipal Construction Documents, Volume II, Instructions to Tenderers – Part II
LED	Light Emitting Diode

Lux	A Unit of Illuminance
BCBC	British Columbia Building Code
R.V.	Recreation Vehicle
BC Transit	BC Transit provides planning, marketing, fleet and funding support for all transit services in BC, except for the Greater Vancouver region.
CPTED	Crime Prevention Through Environmental Design
CAN	Canada
TTY	Teletypewriter
TT	Text Telephone
TTY/TT	Teletype/Text Telephone
TDD	Telecommunications Device for the Deaf



Plan and Design for Choice

Universal Design Guidelines for Outdoor Spaces © 2009

January 2009 — First Edition