

LEADING

Volume 7, Issue No. 4

EDGE

DIRECTED ENERGY

Applications Across Land, Air, and Sea



Challenges & Solutions
for the 21st Century

Report Documentation Page

Form Approved
OMB No. 0704-0188

Public reporting burden for the collection of information is estimated to average 1 hour per response, including the time for reviewing instructions, searching existing data sources, gathering and maintaining the data needed, and completing and reviewing the collection of information. Send comments regarding this burden estimate or any other aspect of this collection of information, including suggestions for reducing this burden, to Washington Headquarters Services, Directorate for Information Operations and Reports, 1215 Jefferson Davis Highway, Suite 1204, Arlington VA 22202-4302. Respondents should be aware that notwithstanding any other provision of law, no person shall be subject to a penalty for failing to comply with a collection of information if it does not display a currently valid OMB control number.

1. REPORT DATE 2012	2. REPORT TYPE	3. DATES COVERED 00-00-2012 to 00-00-2012			
4. TITLE AND SUBTITLE Leading Edge. Volume 7, Issue Number 4		5a. CONTRACT NUMBER			
		5b. GRANT NUMBER			
		5c. PROGRAM ELEMENT NUMBER			
6. AUTHOR(S)		5d. PROJECT NUMBER			
		5e. TASK NUMBER			
		5f. WORK UNIT NUMBER			
7. PERFORMING ORGANIZATION NAME(S) AND ADDRESS(ES) Naval Surface Warfare Center, Dahlgren Division, Corporate Communications, C6,6149 Welsh Road, Suite 239, Dahlgren, VA, 22448-5130		8. PERFORMING ORGANIZATION REPORT NUMBER			
9. SPONSORING/MONITORING AGENCY NAME(S) AND ADDRESS(ES)		10. SPONSOR/MONITOR'S ACRONYM(S)			
		11. SPONSOR/MONITOR'S REPORT NUMBER(S)			
12. DISTRIBUTION/AVAILABILITY STATEMENT Approved for public release; distribution unlimited					
13. SUPPLEMENTARY NOTES					
14. ABSTRACT					
15. SUBJECT TERMS					
16. SECURITY CLASSIFICATION OF:			17. LIMITATION OF ABSTRACT Same as Report (SAR)	18. NUMBER OF PAGES 102	19a. NAME OF RESPONSIBLE PERSON
a. REPORT unclassified	b. ABSTRACT unclassified	c. THIS PAGE unclassified			

TABLE OF CONTENTS

Directed Energy

3 LEADING EDGE DIRECTED-ENERGY RDT&E

Captain Michael H. Smith

4 DIRECTED-ENERGY TOPICS IN THIS ISSUE

Mr. Dale Sisson

PAST, PRESENT, AND FUTURE

6 NAVAL DIRECTED-ENERGY WEAPONS – NO LONGER A FUTURE WEAPON CONCEPT

David C. Stoudt

12 HISTORICAL OVERVIEW OF DIRECTED-ENERGY WORK AT DAHLGREN

Stuart Moran

26 HISTORY OF LASER WEAPON RESEARCH

Melissa Olson

36 LASER WEAPON SYSTEM (LAWS) ADJUNCT TO THE CLOSE-IN WEAPON SYSTEM (CIWS)

Robin Staton and Robert Pawlak

RDT&E, ACQUISITION, AND WARFARE MANAGEMENT

44 THE ACQUISITION CHALLENGE ASSOCIATED WITH DIRECTED-ENERGY RDT&E

Mike Kotzian

TECHNOLOGY, MODELING, AND ASSESSMENT

50 THE BASICS OF ELECTRIC WEAPONS AND PULSED-POWER TECHNOLOGIES

Stuart Moran

58 SOLID MODELING OF DIRECTED-ENERGY SYSTEMS

Joseph F. Sharrow

64 A FUNDAMENTAL KEY TO NEXT-GENERATION DIRECTED-ENERGY SYSTEMS

Directed Energy Division, Electromagnetic and Sensor Systems Department

70 ACTIVE DENIAL ARRAY

Randy Woods and Matthew Ketner

74 DIRECTED ENERGY IN THE MILITARY ENVIRONMENT

LT Leedjia Svec, Jeremy Beer, and Dave Freeman

HIGH-POWER MICROWAVE

78 DIRECTED ENERGY USING HIGH-POWER MICROWAVE TECHNOLOGY

Jacob Walker and Matthew McQuage

HIGH-ENERGY LASER

82 LASER COUNTER ROCKET, ARTILLERY, AND MORTAR (C-RAM) EFFORTS

Michael Libeau

NONLETHAL CAPABILITIES

86 MULTIFREQUENCY RADIO-FREQUENCY (RF) VEHICLE STOPPER

Stephen A. Merryman

92 HIGH-POWER ELECTRICAL VEHICLE-STOPPING SYSTEMS

Jordan Chaparro and Melanie Everton

96 NONLETHAL SMALL-VESSEL STOPPING WITH HIGH-POWER MICROWAVE TECHNOLOGY

Jacob Walker

LEADING EDGE

NAVAL SURFACE WARFARE CENTER, DAHLGREN DIVISION (NSWCDD)

Captain Michael H. Smith, *Commander*
Carl R. Siel, Jr., *Technical Director*
David C. Stoudt, *Distinguished Engineer for Directed Energy (ST) and
NAVSEA Technical Warrant for Directed Energy and Electric Weapon Systems*
Janice Miller, *Corporate Communications Director (Acting)*
Steve Zehring, *Managing Editor*
Margie Stevens, *Production Coordinator*
Patrice Waits, *Editor & Layout*
Clement Bryant, *Layout Design & Graphic Artist*
Kellie Yeatman, *Graphic Artist*
Trey Hamlet, *Graphic Artist/3-D Modeling*

ELECTROMAGNETIC & SENSOR SYSTEMS

Dale Sisson, *Head, Q Department*
Brandy Anderson, *Graphic Artist/Cover Design*

NSWCDD

Jordan Chaparro
Melanie Everton
Matthew Ketner
Michael Libeau
Matthew McQuage
Stephen A. Merryman
Stuart Moran
Melissa Olson
Robert Pawlak
Joseph F. Sharrow
Robin Staton
Jacob Walker
Randy Woods

DEFENSE ACQUISITION UNIVERSITY

Mike Kotzian

NAVAL MEDICAL RESEARCH UNIT – SAN ANTONIO

Jeremy Beer
Dave Freeman
LT Leedjia Svec

The Leading Edge magazine is produced by the Naval Surface Warfare Center, Dahlgren, Virginia. The purpose of the publication is to showcase technical excellence across the Warfare Centers and promote a broader awareness of the breadth and depth of knowledge and support available to the Navy and DoD.

Address all correspondence to Corporate Communications, C6
Email: dlgr_nswc_c6@navy.mil; or write to
Commander
Naval Surface Warfare Center, Dahlgren Division
Corporate Communications, C6
6149 Welsh Road, Suite 239
Dahlgren, VA 22448-5130

NSWCDD/MP-09/34

Approved for public release; distribution is unlimited.



Introduction

LEADING EDGE DIRECTED-ENERGY RDT&E



Captain Michael H. Smith, USN
Commander, NSWCCD

Dahlgren first launched research and development efforts devoted to harnessing the power of electromagnetic energy over 40 years ago. From early work with voltage multipliers and pulse-powered technology, to today's high-energy lasers and high-power microwave technologies, the Naval Surface Warfare Center, Dahlgren Division (NSWCDD) has led, and continues to lead, cutting-edge directed-energy research, development, testing, and evaluation. Our commitment in this area only grows stronger—evidenced by our chartering of the Directed Energy Warfare Office (DEWO)—in order to provide increased focus on warfighting applications of these technologies.

Today's military forces face a wide array of challenges in diverse operating environments around the world. Directed energy offers unique and flexible options to address today's challenges, as traditional kinetic weapons are often of limited value in peacekeeping missions and in urban environments, where restricted rules of engagement typify the norm. Kinetic weapons can also be more costly or ineffective to employ against asymmetric threats.

The Chief of Naval Operations (CNO) recently placed added emphasis on directed energy and on expanding the range of directed-energy capabilities. In response, scientists and engineers at NSWCDD are actively developing prototype systems in a number of areas that you will read about in this issue—areas that have been successfully demonstrated and tested in our Navy laboratories and ranges.

In this issue of *The Leading Edge* magazine, you will trace the rich history of directed-energy work at Dahlgren, gain insight into directed-energy weapons already fielded or being readied for the field, and learn about prototypes that show real promise for providing incredibly effective offensive and defensive directed-energy solutions. For example, scientists and engineers at NSWCDD are leading the way toward realizing small, lightweight radio frequency (RF) transmitters using high-power, solid-state switching amplifiers for the development of counter-improvised explosive device detection and neutralization systems. You will also learn about diverse applications of directed-energy technology—such as research and testing of laser glare devices and laser eye protection—and have the opportunity to gain a better understanding of the Department of Defense (DoD) acquisition framework and the challenge of maintaining cost and schedule estimates while delivering weapons systems that are critical to the warfighter.

From lasers to high-power electrical vehicle-stopping systems, I am sure you will be fascinated and, along with me, be impressed with the advancements our scientists, engineers, and technical staff are achieving in the directed-energy arena to support of our men and women in uniform.



DIRECTED-ENERGY TOPICS IN THIS ISSUE



Dale Sisson
Head, Electromagnetic and
Sensor Systems Department
NSWCDD Dahlgren, Virginia

Welcome to our Directed Energy issue of the *Leading Edge* magazine. This issue represents the third in a trilogy of issues covering the truly fascinating and incredibly challenging area of naval warfare in the operational electromagnetic environment. In our first issue, we covered the full range of operational and readiness implications when operating in the electromagnetic environment. Then, in our second issue, we highlighted the complexities and dynamics of providing relevant and effective sensors and radars to our warfighters. Now, we focus on directed energy and relate how the Naval Sea Systems Command (NAVSEA) Warfare Centers, and the Naval Surface Warfare Center, Dahlgren Division's (NSWCDD's), in particular, are working on state-of-the-art directed-energy weapons capabilities for the warfighter.

In this issue, we first look back to the early years, decades ago, when directed-energy weapons research began. We examine the history of directed energy, and we cover significant discoveries and achievements made by NAVSEA Warfare Center scientists and engineers, and others in the scientific community. We then relate information about several of our current directed-energy initiatives, and about how we're working hard to solve some of the most complex technical challenges associated with directed-energy weapons. We highlight how others in the Navy, such as the Naval Medical Research Unit in San Antonio, Texas, are also conducting research into directed energy and how our forces can better protect themselves from the effects of directed energy. We show how directed energy can be employed in a variety of offensive and defensive, lethal and nonlethal situations. We explain how directed-energy weapons work and how they can be employed in various environments against a wide range of situations. Lastly, we look forward as we provide technical and strategic leadership for the efficient and effective development, acquisition, and fielding of directed-energy systems for the warfighter.

So, if you want to learn about what the NAVSEA Warfare Centers and others in the Navy are doing in the area of directed-energy weapons, look no further than this issue of the *Leading Edge* magazine. I'm confident that you will be impressed by the progress made in this most important technology field.

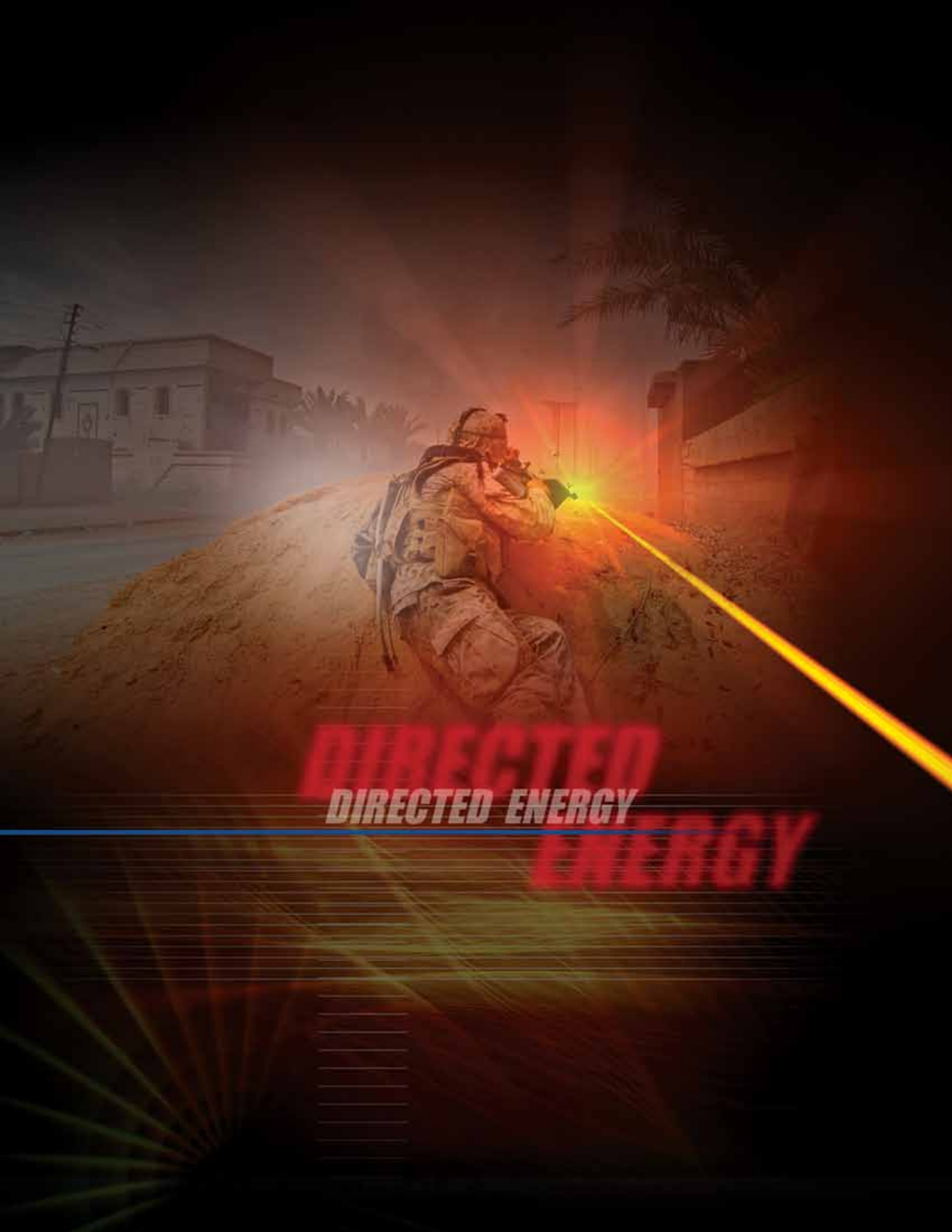

DIRECTED
DIRECTED ENERGY
ENERGY

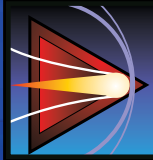

NAVAL DIRECTED-ENERGY WEAPONS — NO LONGER A FUTURE WEAPON CONCEPT

By David C. Stoudt

Dr. Stoudt is the Distinguished Engineer for Directed Energy (ST) and the NAVSEA Technical Warrant for Directed Energy and Electric Weapon Systems.

Directed-energy weapon (DEW) technologies typically take the form of high-energy lasers (HELs), high-power microwaves (HPMs), and charged-particle beams. This article focuses on the first two technology areas, as they have reached the point of being ready for operational testing and evaluation, and in some cases, operational use on the battlefield. DEWs have been popularized in science-fiction writings for over a hundred years. The Department of Defense (DoD) has been investing in their development since the 1970s. This article will not go into technical depth regarding the various directed-energy (DE)-related efforts currently underway in the Navy, but rather, it will overview DE areas under development and relate recent Navy leadership activity. Other articles in this issue of *The Leading Edge* magazine will provide the reader with much greater technical and programmatic details on various DE efforts.

HIGH-ENERGY LASER WEAPONS

HEL weapon systems have been envisioned for a great many years, to include being referred to as Martian “Heat Ray” weapons in H.G. Wells’ epic novel *The War of the Worlds*, originally published in 1898. In reality, a high-average-power laser weapon system is very similar to a “heat ray”, or even a blow torch. During the early years of DoD investments in DE technology, the Navy led the development of HEL with the creation of the world’s first megawatt-class, continuous-wave, Mid-Infrared Advanced Chemical Laser (MIRACL), located at White Sands Missile Range (WSMR). Roughly 80 years after the work of H.G. Wells, the U.S. Navy tested the MIRACL laser and ultimately used that laser system to engage static and aerial targets in the desert of WSMR in the following years. While that laser proved to be the wrong choice for the Surface Navy’s self-defense mission, it did spawn work by the Air Force on the Airborne Laser (ABL), and the Army on the Tactical High-Energy Laser (THEL). In 2000 and 2001, the THEL successfully shot down 28 supersonic Katyusha artillery rockets and 5 artillery shells.



In 2010, the ABL successfully engaged and destroyed tactical ballistic missiles during the boost phase of their flight. All three of these laser systems—the MIRACL, the ABL, and the THEL—are chemical lasers that utilize toxic chemicals and operate in less than optimal wavelengths that make them a poor choice for most naval applications. The MIRACL is shown in Figure 1.

Recent advances in solid-state lasers, to include fiber lasers, have moved these electric lasers to the forefront of the Department's research and development (R&D) for near-term HEL applications in the services. The Navy has particular interest in electric lasers, to include the free-electron laser (FEL), for shipboard self-defense and force protection applications. The speed-of-light delivery of HEL energy can defeat the high-g maneuvers of newly developed foreign antiship cruise missiles (ASCMs). Thus, the Office of Naval

Research (ONR) started an FEL Innovative Naval Prototype (INP) program in FY10, with a goal of reaching the output power of 100 kW. The eventual goal of the FEL program is to reach the multi-megawatt power level with wavelength selectivity. The Naval Sea Systems Command (NAVSEA) Directed Energy and Electric Weapons Program Office (PMS 405) has been actively developing a fiber laser-based Laser Weapon System (LaWS) that could be a retrofit to augment the current capabilities of the Close-In Weapon System (CIWS) currently deployed on many surface combatants. The Naval Surface Warfare Center, Dahlgren Division (NSWCDD), is the Technical Direction Agent and lead system integrator for PMS 405 on the LaWS program. The Naval Air Systems Command (NAVAIR) has interest in compact, solid-state HEL systems for aircraft self-protect and air-to-ground engagements, and will be starting a



Figure 1. Mid-Infrared Advanced Chemical Laser (MIRACL)

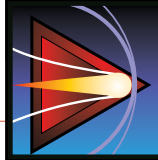

fiber laser-based ONR Future Naval Capability effort in FY12. LaWS is shown in Figure 2.

HIGH-POWER MICROWAVE WEAPONS

Like lasers, microwave weapons have been fantasized about ever since the invention of microwave power generators. In fact, in 1932 it was generally recognized by the British government that bombers, ostensibly German bombers, would be able to penetrate British air space and bomb its civilian population and infrastructures. In 1934, the Air Ministry initially asked Robert Watson-Watt, of the National Physical Laboratory, if he could build a “death ray” that could kill enemy pilots or detonate bombs while they are still on the planes of enemy aircraft. Such a “death ray” had been proposed to the Air Ministry by Harry Gindell-Mathews 10 years earlier in 1924. Watson-Watt, a former

meteorologist who had become an expert on radio signals, suggested that energy reflected from an aircraft could be used to locate it. His experiments were successful and RADAR (radio detection and ranging), a name coined by the U.S. Navy in 1940, was born. While RADAR is not a DEW in the way they are thought of today, its roots can clearly be traced to the military’s desire for such capabilities.

The Navy’s HPM, or high-power radio-frequency (RF) systems, have been progressively increasing in power density to the point where it is now feasible to integrate the technology into weapon systems for deployment. While initial HPM applications suffered from their inability to obtain militarily useful outcomes, either due to technology limitations, difficult concept of operations (CONOPS), or inherent robustness of potential target systems, many feasible military applications for using HPM



Figure 2. Laser Weapon System (LaWS)

devices have surfaced over recent years to include nonlethal, antipersonnel weapons and nonkinetic, antimateriel weapons. While these concepts offer unique capabilities to the warfighter due to the nonkinetic effects they generate, other warfighting concepts—such as stopping vehicles, or countering hidden roadside bombs or improvised explosive devices (IEDs)—are difficult to achieve by any other means. The multifrequency Radio-Frequency Vehicle Stopper (RFVS) system is shown in Figure 3.

In addition, the difficulty in overcoming the propagation losses associated with HPM has driven some concepts into platforms such as unmanned aerial vehicles (UAVs) or cruise missiles that deliver the HPM device to the target for a close-in engagement. Over the past 10 years, field-testable prototypes have been developed to demonstrate the operational utility of these concepts, and in some cases, those prototypes have or will be deployed operationally to support our troops in

theater. It is only through the hard work and perseverance of the Naval Research Enterprise (NRE), as well as other DoD laboratories, that concepts that were once only laboratory curiosities are now making their way onto the battlefield and contributing to the fight.

FOREIGN DIRECTED-ENERGY WEAPON (DEW) DEVELOPMENT

While the United States has been very active in this warfighting area, significant foreign DEW development also has elevated the need for the Navy to afford these threats a higher priority. This can be done either by incorporating the necessary DEW countermeasures into weapon systems, platforms, and critical infrastructures, or by adapting the CONOPS and tactics, techniques, and procedures (TTPs) employed by our armed forces to properly account for those foreign DEW systems. Materiel developers need to understand how this threat



Figure 3. Multifrequency RF Vehicle-Stopper (RFVS) System

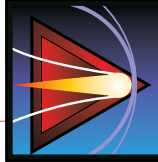

is evolving and properly address it during the design of their systems. They also need to address DE in the development of their system threat assessments. There has been movement on the HPM side to modify existing military standards, such as MIL STD 464¹ and others, to now include information on potential HPM threats. For example, in the HEL arena, work has been accomplished in the development of protective measures for eyes; however, this threat needs to be considered during the system development process. It is well known that building in countermeasures is much cheaper during the initial development of a system, vice trying to retrofit systems with countermeasures once a new threat is on the battlefield. As analysts evaluate the foreign development of DE technologies, and the trends become clearer, it is the responsibility of the acquisition community to take this threat into consideration and ensure that weapon systems, platforms, and infrastructures will be available and at full capability when needed. By accounting for foreign threat developments, assessing blue force susceptibilities and vulnerabilities, and adopting appropriate measures to negate or counter these threats, naval forces will avoid technological surprise on the battlefield in the future.

REQUIREMENTS

The DE programs briefly mentioned in this article, and covered more deeply in this and other publications, offer warfighters unique capabilities not currently found in their arsenal. The continuing problem, however, is matching those unique capabilities to vetted operational requirements. The DE technical community has made great strides in helping the operational community understand the capabilities of DE weapons and their potential military effects on targets. The lack of formal requirements, however, has yielded more of a technology push—rather than an operational pull—of various DE capabilities. Progress has been made, but more effort is required if DE capabilities are to be developed and transitioned between science and technology (S&T), and formal programs of record. Notwithstanding, the current outlook and trends are positive.

A RESURGENCE OF NAVY INTEREST IN DIRECTED ENERGY

The Navy's interest in DEWs for future maritime operations has increased in recent years due to a number of weapons development successes. Recognizing the importance and value of DEWs, NAVSEA reestablished the Navy Directed Energy Weapons Program Office (PMS 405) in 2004.

Accordingly, PMS 405 was designated as the point of contact for matters related to DE and electric weapon systems (EWS) development and acquisition initiation for NAVSEA, and for matters being coordinated with other federal agencies and military services. PMS 405's mission is to transition technology from the laboratory to prototype/advanced development/testing for operational development and use.^{2,3}

The Navy also established its first formal executive position for DE (ST-level), the Navy's Distinguished Engineer/Scientist for Directed Energy, at NSWCDD in August 2004. Following the establishment of this position, NAVSEA then formally established a Technical Authority Warrant for Directed Energy and Electric Weapon Systems (DE&EWS)—Surface Ships in July 2008. The scope of the warrant includes the transition of S&T development to weapon system development of lethal and nonlethal capabilities associated with the DE&EWS for Surface Ships.⁴ This included, but was not limited to, the following:

- Laser Weapon Systems
 - ◆ High-Energy Lasers
 - ◆ Solid-State Lasers
 - ◆ Free-Electron Lasers
 - ◆ Femtosecond Ultrashort Pulse Lasers
 - ◆ Laser-Induced Plasma Channel
 - ◆ Lethality/Vulnerability
- Electromagnetic Rail Gun Weapon System
- High-Power Microwave
 - ◆ Active Denial System
 - ◆ Laser-Guided Energy
- Maritime Directed Energy Test Center
- Electromagnetic Launch of Weapons (excluding the Electromagnetic Aircraft Launch System (EMALS))

Then, within the NAVSEA Warfare Center Enterprise, Warfare Center leadership established two technical capabilities (TCs): an NSWCDD TC for DE systems research, development, test, and evaluation (RDT&E); and a Naval Surface Warfare Center, Port Hueneme Division (NSWCPHD) TC for in-service engineering, test and evaluation (T&E), and integrated logistics support to DE systems. NSWCDD leads all S&T and RDT&E for the development and weaponization of DE systems for surface, air, and ground environments. It also leads the development of offensive and defensive DE technologies needed to characterize and exploit vulnerabilities, provide weapons, and protect against attack. NSWCDD provides the technologies, devices, and systems designed to create or control electromagnetic energy used to cause persistent disruption or permanent damage by attacking target materials,

electronics, optics, antennas, sensors, arrays, and personnel, including nonlethal applications. NSW-CPHD provides in-service engineering, T&E, and integrated logistics support to DE systems throughout the system life cycle.

The Navy further demonstrated increased interest in DE when Assistant Secretary of the Navy (Research, Development & Acquisition (ASN(RDA))) designated NAVAIR offensive and defensive leads for naval aviation DE activities:

- Program Executive Officer for Unmanned Aviation and Strike Weapons (PEO(U&W)), assigned as the offensive DE lead for naval aviation
- PEO for Tactical Aircraft Programs (T), assigned as the defensive lead for naval aviation

Concerning future initiatives, the Chief of Naval Operations (CNO) tasked the Strategic Studies Group (SSG) to examine a topic entitled “Maritime Operations in the Age of Hypersonic and Directed-Energy Weapons.”²⁵ The intent of the study was to provide Navy leadership with an understanding of where DE technologies and weapons are today and how they might influence future maritime operations. The theme of the study was completed during FY10, the results of which discuss many DE concepts, as well as tactics for the employment of DE capabilities. The study’s findings are currently under review and consideration by senior Navy leadership.

CONCLUSION

While H.G. Wells’ *The War of the Worlds* novel and television programs like *Star Trek* popularized the notion of using DE for weapons in years past, today— through persistent DEW RDT&E— Navy leadership is realizing the great potential that DEWs offer naval warfighters and homeland defenders. The scientific and technical advances the Navy has made in HEL and HPM in recent years have been nothing short of extraordinary. Moreover, future technological and engineering advances undoubtedly will result in profound differences in our nation’s future warfighting capabilities. Naval DEWs, therefore, are no longer just a future weapon concept...they are here today.

REFERENCES

1. Department of Defense Interface Standard, *Electromagnetic Environmental Effects—Requirements for Systems*, MIL-STD-464, 18 March 1997.
2. NAVSEA Notice 5400, Ser 09B/240, Subject: Establishment of the Navy Directed Energy Weapons Program Office (PMS 405), dated 4 January 2002.
3. NAVSEA Instruction 5400.101, Ser SEA 06/058, Subject: Directed Energy and Electric Weapons Program Office (PMS 405) Charter, dated 21 July 2004.
4. NAVSEANOTE 5400 Ser 09B/240 of 4 January 2002 and NAVSEAINST 5400.101 Ser SEA 06/058 of 21 July 2004.
5. Letter from the CNO tasking the SSG XXIX Theme—“Maritime Operations in the Age of Hypersonic and Directed-Energy Weapons,” dated 23 September 2009.

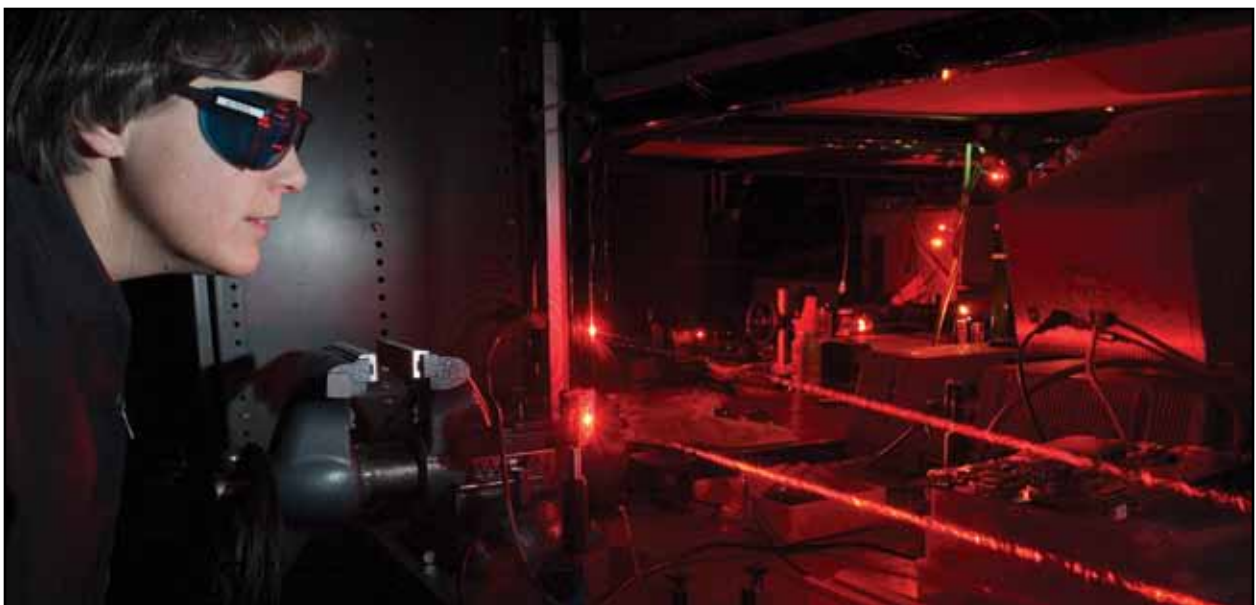



HISTORICAL OVERVIEW OF DIRECTED-ENERGY WORK AT DAHLGREN

By Stuart Moran

In 1962, the United States set off a megaton nuclear weapon 250 miles above the Pacific. The blast caused a large imbalance of electrons in the upper atmosphere that interacted with the Earth's magnetic field to create oscillating electric fields over a large area of the Pacific. These fields were strong enough to damage electronics in Hawaii, a thousand miles away, and clearly demonstrated the effects of an electromagnetic pulse (EMP). It didn't take long for the military to begin considering ways to create such pulses without using nuclear weapons.

In the late 1960s, the Special Applications Branch at the Naval Weapons Laboratory at Dahlgren began studying ways to generate high-power oscillating electric fields that could be used as a weapon to damage enemy electronics. These devices were basically high-power versions of the old spark-gap transmitters used in the early days of radio. To construct a device that could produce nuclear EMP-like fields, stored electrical energy was converted to radio-frequency (RF) energy that could be radiated from an antenna through the atmosphere to a target. These devices typically would store energy in a high-voltage capacitor and release the energy quickly using a spark-gap switch. This would then drive oscillating currents on an antenna, causing it to radiate. To achieve field strengths of thousands of volts per meter, typical of a nuclear EMP, devices operating at hundreds of thousands of volts or more were needed.

A number of radiating devices were studied in the early 1970s. Most belonged to a class of devices called Hertzian oscillators. A capacitor is charged to high voltage, the switch is closed, and current flows in the circuit, causing the stored energy to oscillate between the electric field of the capacitor and the magnetic field of the inductor. To charge the capacitor to extremely high voltages, a step-up transformer of some type must be used. One of the fastest voltage multipliers, the Marx generator, was frequently used. The losses from internal resistance and external radiation damp the oscillating waveform, typically after a few cycles. The radiated pulses are, therefore, short in time and broad in frequency content.¹ A simple diagram of the inductance-capacitance oscillator (L-C oscillator) is shown in Figure 1.

SINGLE-PULSE BURNOUT DEVICES

Many types of Hertzian devices were designed, constructed, and tested at Dahlgren during the 1970s. The transmission-line oscillator, or cavity oscillator, used a quarter-wavelength



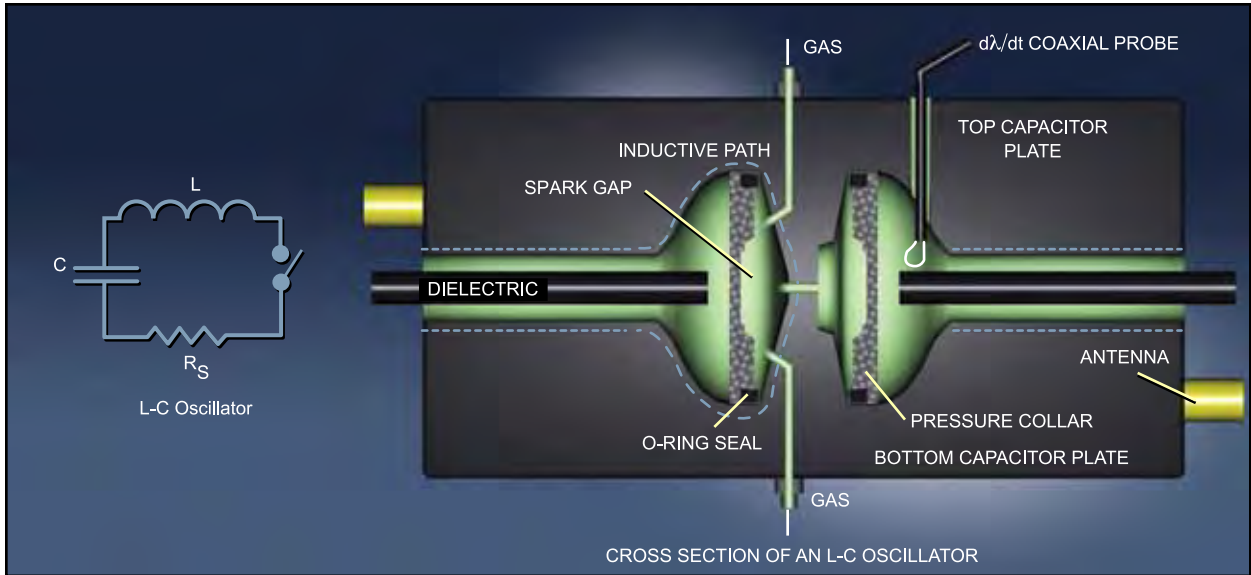

Figure 1. Inductance-Capacitance Oscillator (L-C Oscillator) Diagram

coaxial pipe, which was switched at one end, to create the oscillating waveform. A frozen wave generator, a different type, had quarter-wave sections of cable that were charged plus and minus to create a two-cycle waveform “frozen” in the cable. All sections were simultaneously switched, causing the wave to travel to an antenna. A special folded design was developed so one switch could be used, eliminating the multiswitch synchronization problem. A Ross circuit used a square wave pulse, which traveled down cable “tees,” creating reflections, which were timed to create several RF cycles. In the Travetron, the turn-on time of a series of spark-gap switches was incorporated as a designed delay, creating reflections through a series of gaps to produce the waveform. This design allowed higher frequencies. All of these devices were designed, built, and tested to determine power and frequency capabilities, as well as efficiency.

Scientists and engineers at Dahlgren built and tested versions of Hertzian oscillators operating up to half a million volts. These devices powered relatively simple monopole or dipole antennas that could produce very high electric fields at hundreds of meters. In the early 1970s, a special outdoor field-measurement range was constructed. It housed high-voltage systems in underground trailers that fed antennas above ground on a specially-built, 100-m-long ground plane that was constructed for testing and field measurements. A picture of the ground plane in a fielded measurement range is shown in Figure 2. Field probes were even carried aboard helicopters to make measurements above ground effects, as shown in Figure 3.

Other types of devices to produce pulses were constructed, too. Vector inversion generators used spiral-wound capacitive plates to generate high voltages without transformers.^{2,3} The Landecker ring used a paddle-wheel arrangement of capacitors and inductors charged in parallel and discharged in series. The circular arrangement was designed so the entire system would radiate as a magnetic dipole, thus forming its own antenna.⁴ Switch timing was critical, and Dahlgren engineers attempted to verify reports that Landecker developed a specific type that brought all capacitor leads into a single-center spark gap.

Scientists and engineers also looked at devices that used explosives to generate the electrical energy needed. These included explosive flux compressors of several types, which generated fields and then explosively squeezed the fields between conductors to amplify the peak power. In the early 1970s, a large (70-ft clear zone) anechoic chamber was constructed at Dahlgren with an explosive chamber in one end. Explosives would be set off in the chamber to drive various types of flux compressor schemes that would generate electrical pulses fed into an oscillator and antenna in the anechoic chamber. Pulse parameters and field strengths could be measured. Impedance-matching networks, matching transformers, and methods of improving efficiency were studied. Tests were performed at Dahlgren and at Los Alamos using large antennas suspended from balloons.⁵ In other schemes, piezoelectric devices were developed, which could be compressed hydraulically and then quickly released to produce high voltages. The concept was to use explosives to generate the high

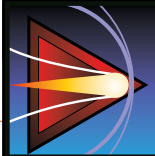

Figure 2. Field Measurement Range



Figure 3. Airborne Electric Field Measurements

pressures. Ferroelectric and ferromagnetic transducers driven by explosives were also tested.⁶

SPECIAL EFFECTS WARHEAD (SEW) PROGRAM

In 1973, Dahlgren began the SEW Program to look at the feasibility of “burning out” enemy radar and missile systems using single-shot, very high-peak-power EMPs. The program looked at the feasibility of constructing an electromagnetic warhead that could disable electronics beyond a normal hard-kill explosive range as far as a mile away. The program was funded at several million dollars a year through most of the 1970s.

A major thrust of the SEW Program was to better understand the effects of high fields on military electronics. Little information was available on the vulnerability of foreign or U.S. electronics, particularly entire systems. A trailer-based RF impulse system, employing a Marx-driven L-C oscillator charged at two million volts, was constructed at Dahlgren. This Transportable Oscillating Pulser System (TOPS) was connected to a large bounded-wave structure that produced uniform fields over a region large enough to place an entire radar or missile system. The electric field emitted from the throat of this system was so high that a special bag of high-voltage gas was needed until the radiating structure became large enough to transition to the normal atmosphere. A picture of TOPS is shown in Figure 4.

Since many important target systems were not available for testing, much of the vulnerability information was obtained from U.S. electronics, and estimates were then made for foreign systems. In addition to the tests done at Dahlgren, pulsers were also constructed in mobile trailers that could be transported to other sites for testing against simulated or actual targets. The Mobile Oscillating Pulser System (MOPS) was an example that was carried to test sites, such as China Lake, to perform tests against radars and simulated foreign systems.

A key requirement for the SEW Program was to demonstrate enforceable target vulnerability, which means that a high percentage of the time a large percentage of the targets are affected. One important finding was the broad difference between an electromagnetic safety concern—where a 1 percent vulnerability was far too great—and a weapon concern—where a 10 percent vulnerability was not good enough. The field strengths between the safety requirements and weapon requirements often were many orders of magnitude apart.

The SEW Program looked at many types of electronic component vulnerability, subsystem vulnerability, and complete system vulnerability. As a result, energy tables for burnout effects were developed. Subsequently, Dahlgren performed numerous field tests against radar and communications systems between 1973 and 1978, and funded component and subsystem testing on missiles.



Figure 4. Transportable Oscillating Pulser System (TOPS)

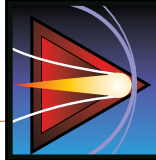

REPETITIVE SYSTEMS FOR ELECTRONIC WARFARE

The electric fields required to damage military electronics in the 1970s often were very high, and ranges typically were limited. As a spinoff of programs trying to damage targets with a single pulse, some of these devices were reduced in size and power, and operated in a repetitive mode to generate noise pulses for the purpose of electronically jamming target systems. In 1976, the Naval Air Systems Command (NAVAIR) began the Electromagnetic Countermeasures Program to study the application of high-repetition-rate Hertzian devices for use as noise jammers. The initial targets were low-frequency radars.

In late 1976, Dahlgren performed effectiveness tests against various radars using helicopter-mounted Hertzian jammers. These devices were able to screen incoming target aircraft at useful ranges. The concept of a forward-launched rocket to deliver a parachute-suspended Hertzian jammer also was investigated. Dahlgren teamed with engineers at China Lake to study packaging concepts of utilizing an extended 5-inch Zuni rocket as a forward-fired delivery vehicle. A prototype is shown in Figure 5.

Similar Hertzian devices were considered for use as communications and data-link jammers. Several antenna deployment schemes were developed, and by fall 1978, successful ground launches had been performed in which the deployment sequence and jammer operation were demonstrated. The name Zuni Expendable Pulsed-Power Oscillator (ZEPPPO) was given to the project. Dahlgren



Figure 5. ZEPPPO Payload

teamed with the Naval Avionics Center (NAC) to build the systems. By 1980, China Lake fired the first air-launched prototypes at both low and high altitudes. Devices, batteries, spark gaps, and antennas continued to be developed, and new targets—such as spread-spectrum systems—were tested. Other delivery systems besides rockets were also considered.

THE PULSED POWER TECHNOLOGY PROGRAM

Large directed-energy weapons (DEWs) often required megawatts or gigawatts of peak power, so methods of supplying and modifying this power were needed. As Dahlgren became involved in a broad range of DEW systems, one attribute became more and more obvious: the size, weight, and cost of a directed-energy (DE) system were dominated by the pulsed-power technologies needed to drive the system, not by the source device itself. Consequently, more effort began to be devoted to the power-delivery technologies needed for many of the weapon concepts. Pulsed-power components enabled energy to be stored over long periods of time (seconds) and released very quickly (nanoseconds) to obtain a billion times increase in peak power.

Dahlgren hosted a pulsed-power systems symposium and workshop in 1976 and helped initiate the International Pulsed Power Conferences, which began in 1977 and continues today under the Institute of Electrical and Electronics Engineers (IEEE). As Dahlgren's involvement with systems design increased, it became apparent that new technologies were needed in the prime-power and pulsed-power area to support a variety of new concepts. Dahlgren urged the Navy to initiate a Pulsed Power Technology Program to develop power sources, energy storage systems, high-power switches, and power conditioning systems needed for a variety of future weapons. This program was initiated in 1978 and was originally funded by NAVAIR and then by the Directed Energy Program Office (PMS 405) in the early 1980s. In addition to the Pulsed Power Technology Program, PMS 405 also began funding free-electron lasers (FELs), chemical lasers, high-power microwaves (HPMs), and charged-particle beams (CPBs). The Pulsed Power Technology Program at Dahlgren, in turn, funded many areas of research, both internal and external, over the next 10 years. Dahlgren served as the focal point for the Navy's science and technology (S&T) in pulsed power and funded many universities, government laboratories, and commercial companies under the Pulsed Power Technology Program.

To provide large amounts of electrical prime power, new types of rotating machines were studied, including flywheels, conventional alternators, homopolar generators, rotary flux compressors, and compensated pulsed alternators. These machines attempted to produce fast, high-power pulses using special materials to reduce losses, eddy currents, and mechanical stresses. MHD generators were developed using rocket-motor propellant that could be started and stopped. In the mid-1980s, a full-scale hybrid (solid fuel/liquid oxidizer) combustor was fabricated and tested at 10 MW, achieving world records for power-to-weight ratio and conductivity. By 1980, new types of energy storage systems were studied, including inductive storage and advanced capacitors using new types of insulating materials and geometries. During the late 1980s, programs such as the Mile-Run Capacitor Program reduced the capacitor size by a factor of 10 through better synthesis of polymer films.

Beginning with internal independent research funds, Dahlgren developed liquid dielectric materials based on water/glycol mixtures at low temperatures. These water-capacitor devices could hold energy for orders-of-magnitude longer time periods than ever before, allowing pulseforming lines to be constructed that could be charged directly from rotating machines. Dahlgren scientists developed a world-record high-voltage water capacitor that could hold pulses for milliseconds and became internationally recognized experts in water breakdown.^{7,8}

High-power fast switching was another important area of research. Dahlgren funded companies to develop new types of multistage thyratrons that could operate at very high voltages. By the early 1980s, multistage thyratrons capable of operating at over 200 kV, 40 kA with 20 nsec risetimes were demonstrated. Vacuum switches, ignitrons, plasma pinch switches, pseudospark switches, back-lighted thyratrons, and e-beam switches all were studied, as well as a variety of spark-gap switches. Higher power solid-state switches were developed, too, using new geometries and substrate material. Superconducting coils were considered, both for energy storage and as opening switches. Dahlgren engineers developed exploding-wire opening switches, and several types of plasma pinch switches were funded. They also worked on stacked cable pulsers. Additionally, concepts for electromagnetic armor were developed. These systems used high-density capacitors to blunt penetrators. Inductive energy storage—which could be far denser than capacitors—was studied, including methods of generating the seed current and the problematic

high-voltage opening switch. Opening switches—which were needed for inductive energy store systems—were studied, as well as magnetic switches, which used saturating magnetic material to sharpen pulses. Magnetic switches operating at 10 kHz were demonstrated by 1983.⁹

In 1985, Dahlgren used internal funds to upgrade a facility to provide controls, diagnostics, and 200 kW of average power at 50 kV to accommodate testing of new switches and water-based capacitors. This facility could control the power with a vacuum-tube pulser and could generate over a million volts with a rep-rated Marx generator. The facility was used to:

- Develop water-dielectric energy storage, rep-rated spark gaps, and pseudospark switches.
- Test a variety of switches developed by contractors, such as back-lighted thyratrons.^{10,11}

A picture of one system being tested—a water pulseforming line and spark-gap switch—is shown in Figure 6.

Dahlgren concentrated in-house switching efforts in spark gaps. New types of gases were studied, as well as electrode materials, gas-flows, switch geometries, and triggering techniques to produce high-repetition-rate switches for electronic warfare, as well as particle-beam weapons.¹² Dahlgren scientists and engineers demonstrated 100- μ s recovery of spark-gap switches after handling kilojoules of energy at hundreds of kilovolts, a world record.¹³ The High Energy 2-Pulse System for fast recovery experiment is shown in Figure 7.

In 1986, Dahlgren ran a workshop on high-power switching for Navy tactical and Department of Defense (DoD) strategic applications and became involved with numerous DoD working groups on electromagnetic propulsion, high-power diagnostics, advanced energy conversion, power modulators, and pulsed power. Spark gaps were investigated to create underwater noise for submarines. Dahlgren also led four North Atlantic Treaty Organization (NATO) Advanced Study Institutes in Europe and the UK on various pulsed-power topics. International assessments of key pulsed-power technologies were also performed.

PARTICLE-BEAM WEAPONS

Particle-beam weapons were a major focus of DE work during the 1970s and 1980s. A CPB weapon takes subatomic particles, generally electrons, and accelerates them to near the speed of light before sending them toward a target. These fast electrons penetrate deeply into most materials, so they are difficult to counter. The high-current electron beam was to be accelerated by an induction-type

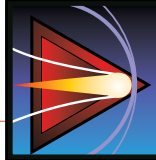

Figure 6. A Water Pulse-Forming Line and Spark-Gap Switch Test

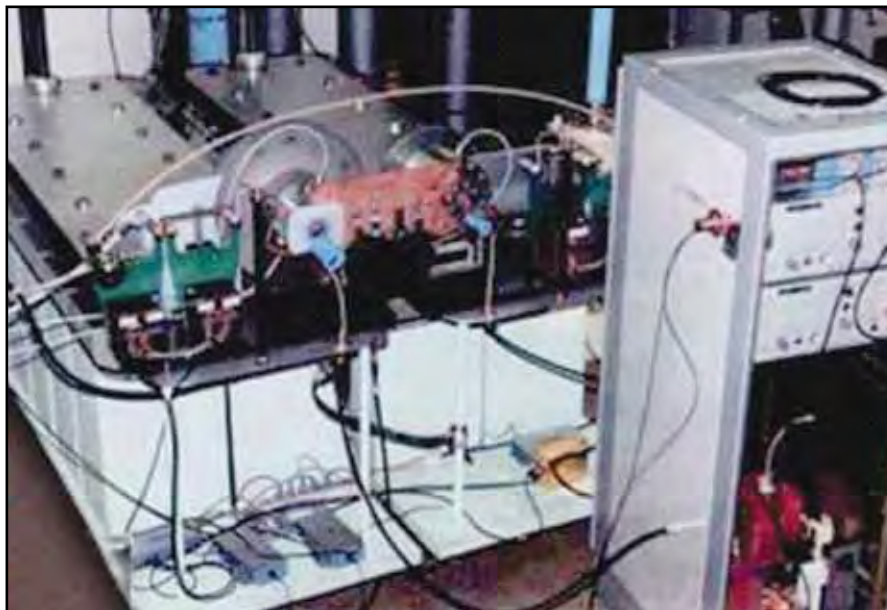

Figure 7. High Energy 2-Pulse System

accelerator, repetitively pulsed. High electron-beam currents (kiloamps) and a hole-boring series of pulses were anticipated to create a stable, long-range beam. Since the beam was capable of penetrating quickly and deeply into any target material, it had the potential to damage electronics and set off explosives before salvage fuzing could occur. The beam was predicted to be all-weather and essentially countermeasure-proof. Even a near miss could cause substantial damage from high fields and X-rays produced by the deceleration of electrons as they hit air molecules near the target. The CPB concept is shown in Figure 8.

Scientists and engineers from Dahlgren worked on the pulsed-power technologies needed to drive these machines beginning in 1980, and it became a major focus of the Pulsed Power Technology Program.¹⁴ The White Oak Laboratory developed beam-steering concepts and looked at material interactions. By 1989, the program investigated:

- Propagation
- Compact Recirculating Accelerators
- Pointing and Tracking
- Prime Power
- Material Interaction
- Fratricide

For a compact shipboard system, recirculating accelerators were needed to make multiple passes of the electron beam past the accelerating cavities. This required a high-power, fast recovery switch, which Dahlgren began working on in 1988. Using patented hydrogen switches and special triggering techniques—efforts that had begun with internal research funds—Dahlgren demonstrated spark-gap switches, the only technology that could meet

the current, voltage, and recovery requirements at that time.¹⁵ The High-Voltage 5-Pulse System experiment is shown in Figure 9.

During these technology efforts, significant advances were achieved in all aspects of the program. These included:

- Generating high-current, high-energy beams (although still below weapons parameters)
- Demonstrating a 360° turn in a high-current beam
- Propagating a single pulse through the air
- Demonstrating beam steering on a small scale
- Performing target interaction measurements

Multipulse, long-range propagation was never demonstrated. A comprehensive tri-service summary called the Net Technical Assessment for CPB was sponsored by the Defense Advanced Research Projects Agency (DARPA) in 1987 to describe the accomplishments of the program. The report said compact accelerators were the most pressing technology need. As a result, most funding was directed toward this topic. Funding was stopped in the early 1990s, however, due to the high expense, stretched timelines, and changes in the threat.

PULSED POWER AND ELECTROMAGNETIC LAUNCHERS

During the 1980s, the Army and Air Force looked at short-range electromagnetic weapons to penetrate stronger armor with higher velocities. The Navy worked on concepts for a weapon that could be mounted on ships to intercept missile systems at line-of-sight distances. The Navy—then the biggest user of space systems—was also interested in studies showing that small satellites could

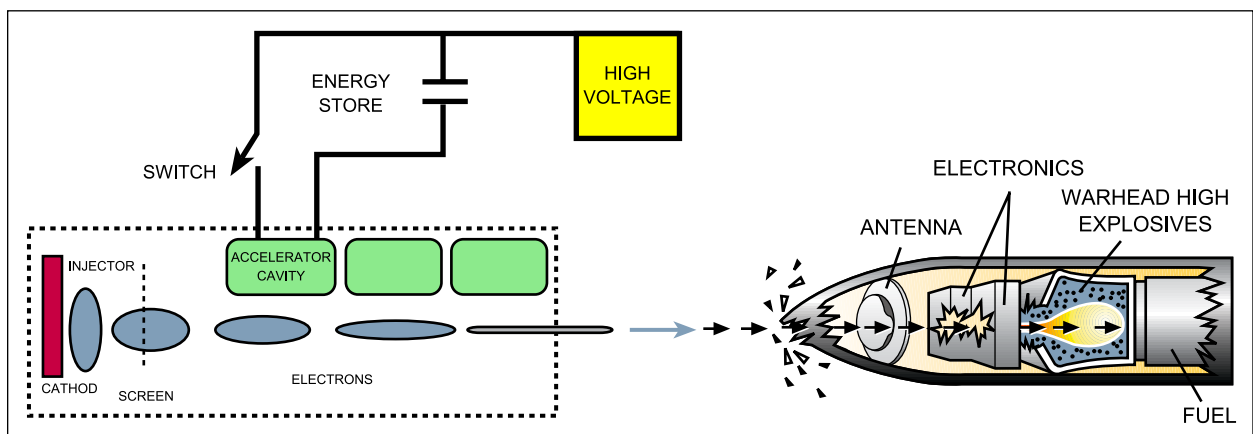

Figure 8. Charged-Particle Beam (CPB) Concept

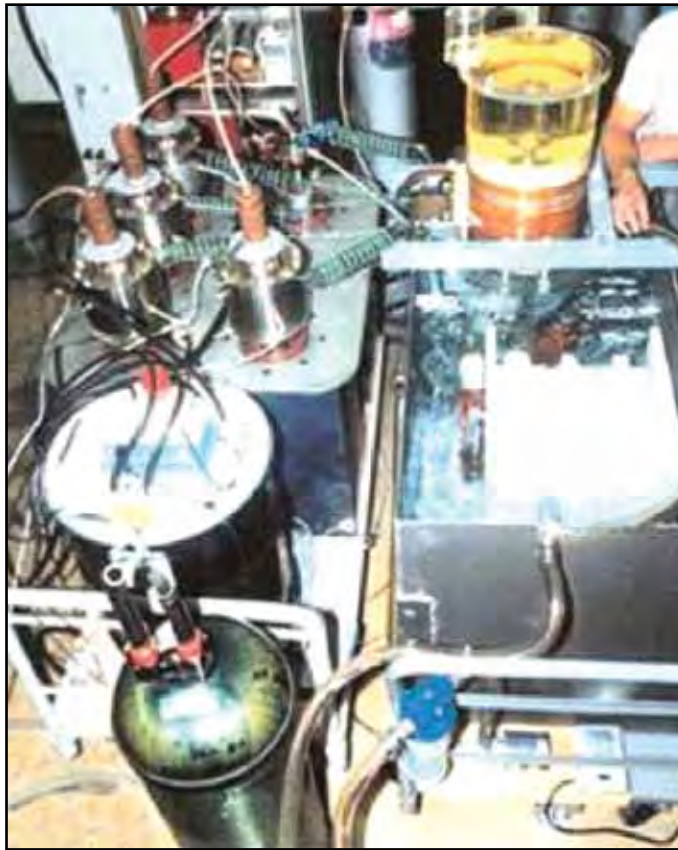
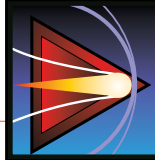

Figure 9. High-Voltage 5-Pulse System Experiment

be electromagnetically launched into low Earth orbit for the fraction of the cost for a normal launch.

Through the 1980s, electric guns were funded by independent research and independent exploratory development programs at Dahlgren, studying electric gun concepts for both rail guns and electrothermal (ET) guns. Kinetic energy weapons were also investigated as part of the Pulsed Power Technology Program. Under these programs, pure electric launchers were developed and tested at Dahlgren, including ones that self-formed projectiles.¹⁶⁻¹⁸ Also studied were ET guns that used the discharge of electrical energy at the gun breech to generate a plasma jet. This plasma jet heated a low-molecular-weight working fluid, such as water, to produce a heated gas that accelerated the projectile to higher velocities than conventional explosives. The Electrothermal-Chemical (ETC) Gun concept augmented the electrical energy generating the plasma jet with a chemical reaction. A 127mm ETC gun was investigated, and a 60mm ETC gun was tested at Dahlgren, with the ability to fire short bursts at a rate of 100 rounds per minute.¹⁹

Early Dahlgren work on electromagnetic launchers—along with capacitor development and switch advances from the Pulsed Power Technology Program—allowed Dahlgren to provide the Navy with detailed conceptual designs in the late 1990s for near-term, long-range rail guns based on capacitor energy store. These efforts helped support the decision to begin a long-range rail-gun program at Dahlgren that continues today, resulting in world-record achievements. Capital investment funds were used to construct a high-energy facility in 2005 to test pulsed-power components and module designs for use in electromagnetic launcher programs. An early electromagnetic launcher is shown in Figure 10.

HIGH-ENERGY LASERS (HELs)

In general, megawatts of continuous laser power are required to kill hard targets at long ranges. Laser technologies that can produce this much power are very limited. The Navy was a leader in developing powerful chemical lasers in the 1970s and 80s. These lasers burned chemical reactants to



Figure 10. Early Electromagnetic Launcher at Dahlgren

generate the excited states for lasing, thus reducing the need for large amounts of electrical power. The Navy built an entire HEL system, including the Mid-Infrared Advanced Chemical Laser (MIRACL) and the Sea-Lite beam director. By 1990, this building-sized system demonstrated shooting boosters, missiles in flight, and supersonic vehicles. However, the system had drawbacks because it:

- Used hazardous, expensive chemicals
- Had propagation problems at the mid-infrared wavelength
- Was large in size and high in cost

FELs require electron accelerators similar to CPB weapons, so they also are large and complex. However, they can be designed to operate at optimum wavelengths and scale nicely to higher powers. The Strategic Defense Initiative began working on FELs in the late 1980s, funding the advanced test accelerator at LLNL, originally developed for CPBs. FELs were also studied under the Strategic Defense Initiative Organization (SDIO) to be used as an antisatellite weapon. These lasers went from milliwatts to watts under SDIO, and then to kilowatts more recently with work at the Thomas Jefferson National Accelerator Facility in Virginia.

Space-based lasers and relay mirror systems were studied under SDIO funding, too, including the development of the Advanced Beam Control System for beam steering, beam control, rapid optical retargeting, and self-alignment.

Dahlgren engineers concentrated its internal laser efforts on medium-power soft-kill weapons. They performed tests against sensors and cameras, and investigated damage thresholds. In the late 1980s, Dahlgren engineers worked with optical augmentation to locate enemy optics for targeting and on green laser dazzlers for defense against small-boat attack. There were efforts to harden electro-optical equipment, including sights and night-vision systems for the Marines, and laser eye-protection filters for goggles and binoculars. Laser systems were also investigated for remotely cutting holes and wires to disable electronics. Lethality work continued under funding from the Joint Technology Office for High-Energy Lasers to look at alternative wavelengths and pulse shapes in addition to modern target materials.²⁰

Dahlgren scientists continued to investigate laser-damage thresholds for materials, components, and subsystems for a variety of laser technologies. Near the start of the 21st century,

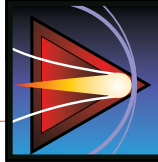

commercial lasers based on pumping optical fibers with semiconductor lasers became common and more powerful. Dahlgren purchased the Navy's largest collection of fiber lasers in 2004 and began investigating ways to combine multiple beams into a laser weapon. These lasers have very high efficiencies, above 20 percent, and the fiber-optic output reduces the requirement for complex optical paths. In 2008, Dahlgren engineers demonstrated a laser capability to ignite spinning mortar rounds, and in 2009, engineers demonstrated the capability of fiber lasers in a shoot down of soft targets at China Lake, California.

RESURGENCE OF DIRECTED ENERGY

With the fall of the Soviet Union and a greatly altered threat, DoD funding (particularly technology funding) experienced an overall decline in the late 1980s and early 1990s. This caused Navy managers to emphasize near-term, lower risk, evolutionary concepts. The Pulsed Power Technology Program and the Navy's Charged Particle Beam Program both came to an end. Investigations into HPM weapons declined as the difficulty of burn-out of military electronics—particularly analog components—became apparent. Problems with propagation and cost caused the Navy to greatly reduce efforts on chemical lasers. With the cancellation of major programs, Dahlgren used internal funding in 1990 to keep a core technical capability together, which was necessary for the Center to remain in the mainstream of tactical DE and its associated technologies. Efforts continued in water breakdown, testing of contractor-developed pulsed-power components, and electric guns. New talent and technologies from universities were brought in to jump-start new projects. Tunable waveform generators using unique semiconductor materials were developed. These used bulk semiconductor material, fabricated in-house, that could be used as a fast switch controlled by laser light for both on and off operation. This allowed faster repetition rates and better triggering than could be done with small spark gaps, as well as the ability to create specific waveforms.²¹ "Green" technologies were also investigated using non-thermal plasmas and spark-gap shock waves for cleaning and pollution reduction.²² New types of particle detectors and magnetic field sensors were developed, and new methods of infrastructure protection were investigated.²³ Soft-kill weapons, both optical and HPM, continued to be studied. Short-pulse jamming of spread-spectrum systems was investigated, as well as beat-wave coupling and special waveforms.²⁴

A number of trends led to a resurgence of DEWs by the end of the 20th century. The DoD trend in using digital electronics and off-the-shelf commercial technologies increased dramatically. The pace of change in electronics and computers changed rapidly, too. Most of these new electronic systems had never been tested for vulnerability, and there was a question of how much they would increase military vulnerability to RF or HPM attack. The reduced emphasis on nuclear EMP shielding meant more military electronics were not as well protected from RF attack. Consequently, interest in protecting U.S. military and civilian infrastructure increased, including systems in foreign countries. Moreover, with the increasing reliance on civilian infrastructure, such as power, communications, and emergency and industrial systems—all of which were controlled by digital electronics—the potential that an adversary could attack infrastructure systems to affect or divert military operations became an increasing concern. Following several major terrorist attacks during this time period, there was also concern about the impact of an RF attack on airport towers, financial systems, alarm systems, and industrial plants. Human factors—such as a state of confusion experienced by humans—also played an important part in determining the overall effects of an RF attack.

The asymmetric threat—where large numbers of cheap weapons in a swarm attack could overrun a few sophisticated weapons—caused more concern. As the asymmetric threat to the surface Navy pushed the limits of conventional defensive systems, DE—with its speed-of-light propagation, soft-kill potential, and cheap rounds—offered tactical advantages, either as an adjunct to conventional systems or as stand-alone systems. Additionally, there was an increased emphasis on nonlethal, precise accuracy and graduated effects that could be used. Moreover, the idea that future battles would be fought together with civilians and friendly forces on the battlefield increased the importance of low collateral damage and antimateriel attacks.

The Joint Program Office for Special Technology Countermeasures (JPO/STC), located at Dahlgren, began efforts concerning the vulnerability of new digital systems to RF attack. The program also established a DoD-wide database of vulnerability data, source designs, and RF-effects information—bringing together much of the information collected by the services over the years. The program looked at the protection of modern digital infrastructure systems and funded a facility constructed in 1992 to test large-scale electromagnetic vulnerabilities to various methods of attack.

In the late 1990s and early 2000s, Dahlgren initiated programs regarding the potential for RF attack using nonkinetic disruption, with minimal collateral damage. Capital investment funds were used to construct a test facility for this effort in 1998. Dahlgren developed RF payloads for remotely piloted vehicles and demonstrated their effectiveness in field tests in 1999, and in similar tests in 2007. The successful completion of Project Guillotine was DoD's first demonstration of this type of HPM technology. As the need for statistical vulnerability to commercial digital systems became apparent, Dahlgren constructed instrumented test facilities in 1999 and 2002. Two multistory buildings could be reconfigured to reflect different types of building construction and electromagnetic shielding. Large complexes of electronics, computer networks, server systems, telephone systems, security systems, and various types of digital industrial controls could be assembled, instrumented and exposed to attack from an external device or technique. This program-funded complex—called the Maginot Open Air Test Site (MOATS) facility—continues to be used to test target systems, as well as a variety of RF weapon technologies developed internally and by external and international organizations. A picture of the MOATS facility is shown in Figure 11.

As the need for additional DE laboratory space and testing capabilities became apparent, Dahlgren applied for military construction funds, and

in 2008, constructed the Naval Directed Energy Center (NDEC), with access to Dahlgren's over-water test range. Other construction funds were used to construct a remote facility at the Pumpkin Neck Explosive Test Range to serve as a laser backstop and measurement facility, as well as an explosive-test staging area. These facilities already have been used to develop and test fiber lasers against modern threat targets. Construction is currently underway to build an expansion of the NDEC and a 120-m laser test laboratory building using an existing tunnel structure. This collection of facilities represents very important capabilities to develop and test future DE systems.

CONCLUSION

For over 40 years, the Naval Surface Warfare Center, Dahlgren Division (NSWCDD) has been a leader in developing DE devices, pulsed-power systems, and electric weapons. Its people have contributed many publications and patents, and set world records. DEWs tend to be complex and technically challenging to build. Regardless, these weapons offer important, powerful advantages, such as:

- Deep Magazines
- Cheap Rounds
- Fast Targeting
- Variable Lethality
- Pinpoint Targeting

As a result of NSWCDD's leadership, persistent scientific initiatives, and leading-edge engineering



Figure 11. MOATS Facility Undergoing Testing with an RF Weapon (on right)

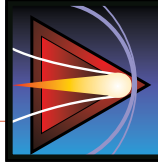

over the years, naval warfighters will increasingly find themselves turning to DEWs when dealing with situations spanning the spectrum of conflict.

REFERENCES

1. Moran, S.L., "High Repetition Rate L-C Oscillator," *IEEE Transactions on Electron Devices*, Vol. ED-26 No. 10, October 1979.
2. Fitch, R.A. and Howell, V.T.S., "Novel Principle of Transient High-Voltage Generation," *Proceedings IEEE*, Vol. III, April 1964.
3. Ramrus, A. and Rose F., "High-Voltage Spiral Generators," *1st International Pulsed Power Conference*, Lubbock Texas, pIIC9, November 1976.
4. Landecker, K.; Skatterbol, L.V. and Gowdie, D.R., "Single Spark Ring Transmitter," *Proc. IEEE*, Vol. 59, No. 7, July 1971, pp. 1082-1090.
5. Erickson, D.J.; Fowler, C.M. and Caird, R., *EM Radiation from an Explosive Generator System Coupled to a Large Antenna*, Los Alamos Scientific Laboratory Report M-6-258, March 1978.
6. Fowler C.M. and Brooks, M.L., *Explosive Flux Compression Devices Project*, ARPA Order No. 2161, Semiannual Technical Report, 1 March 1972-31 August 1972.
7. Zahn, M.; Ohki, Y.; Fenneman, D.; Gripshover, R. and Gehman, V., "Dielectric Properties of Water and Water/Glycol Mixtures for Use in Pulsed Power System Design," *Proceedings of the IEEE*, September 1986, pp. 1182-1221.
8. Gehman, Jr., V.H.; Gripshover, R.J.; Berger, T.L.; Bowen, S.P. and Zia, R.K.P., "Effects of Filtration on the Impulse Breakdown Strength of High-Purity Water," *IEEE 1995 Tenth International Pulsed Power Conference*, Albuquerque, New Mexico, 10-13 July 1995.
9. Moran, S.L., *Pulsed-Power Technology Program: Accomplishments in Switching*, NAVSWC Tech Note TN-89-259, 1990.
10. Berger, T.L.; Gehman, Jr., V.H.; Lindberg, D.D. and Gripshover, R.J., "A 2.5 Gigawatt Liquid Dielectric Coaxial Pulse Forming Line," *Proceedings of the 6th IEEE International Pulsed Power Conference*, Arlington, Virginia, 29-30 June and 1 July 1987.
11. Bernardes, J.S., "A High Power Fast Response Switch Testing System," *7th IEEE Pulsed Power Conference*, June 1989.
12. Moran, S.L. and Hutcherson, R.K., *High-PRF High-Current Switch*, U.S. Patent No. 4,912,396, 27 March 1990.
13. Moran, S.L. and Hardesty, L.H., "High-Repetition-Rate Hydrogen Spark Gap," *IEEE Transactions on Electron Devices*, Vol. 38, No.4, April 1991.
14. Rose, M.F. and Huddleston, C.M., *Pulsed Power and Directed Energy Technology*, 10th Anniversary Technical Symposium, NSWCP MP 84-560, October 1984.
15. Moran, S.L., "Hydrogen Spark Gap for High-Repetition-Rate Compact Accelerators," *NSWCDD Technical Digest*, NSWCDD/MP-92/104, September 1992, pp. 126-139.
16. Bernardes, J.S. and Merryman, S., "Parameter Analysis of a Single Stage Induction Mass Driver," *Proceedings of the Fifth IEEE Pulsed Power Conference*, Arlington, Virginia, June 1985, pp. 552-555.
17. Bernardes, J.S., "Muzzle Velocity Control with Electrothermal Guns," *Proceedings First Navy Independent Research/Independent Exploratory Development Symposium*, Laurel, Maryland, June 1988, Vol. 2, pp. 123-131.
18. Bernardes, J. S., "Focusing Induction Accelerator," *Proceedings of the Sixth IEEE Pulsed Power Conference*, Arlington, Virginia, June 1987, pp. 735-738.
19. Bernardes, J.S., *Sliding Breech-Block for Repetitive Electronic Ignition*, Patent Number: 5,233,902, 10 August 1993.
20. Kim, H.S. et al., "Effects of Chopping Laser Penetration of Metal Targets," *Applied Physics Letters*, 55 (8), 21 August 1989.
21. Stoudt, D.C. and Schoenbach, K.H., "The Electrical Characteristics of Semi-Insulating GaAs for High-Power Switches," *7th IEEE Pulsed Power Conference Proceedings*, June 1989.
22. Grothaus, M.G. et al., "Gaseous Effluent Treatment using a Pulsed Corona Discharge," *Proceedings of 10th IEEE Pulsed Power Conference*, Albuquerque, New Mexico, July 1995.
23. Gripshover, R.J. et al., *Power Frequency Magnetic Field Detection Systems*, Patent No. 6,483,309, 19 November 2002.
24. *Spread Spectrum Countermeasures Final Report*, E-Systems, Inc., Melpar Division under NSWC contract # N68786-82-C-0109.



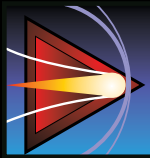

HISTORY OF LASER WEAPON RESEARCH

By Melissa Olson

The idea of using light as a weapon can be traced back to Hippocrates, commander of the Greek forces in 212 B.C. His forces supposedly set fire to the sails of the Roman fleet by focusing sunlight with mirrors. Weapons systems based on lasers and “ray guns,” long a staple of science fiction, have captured the imagination of people everywhere. But with steady progress toward the development of lasers in the last 40 years, viable, state-of-the-art laser weapon systems have now become a reality.

The production of lasers in the modern scientific world is fairly new. The first laser was developed in the 1960s and represented the beginning of a drastic change in how the military viewed warfare. The late 1970s and 1980s, too, marked a busy time period for developing lasers into possible weapon systems. All branches of the military and industry were striving to master high power levels, beam control, and adaptive optics. In 1999, the Department of Defense (DoD) formally recognized lasers as future weapons and began research and development (R&D). In 2000, the Joint Technology Office for High Energy Lasers was formed to bring all laser technologies together to develop a complete laser weapon system that could be used by the warfighter.

ELECTROMAGNETIC SPECTRUM

The electromagnetic spectrum contains all the types of electromagnetic energy, including radio waves, microwaves, infrared, visible light, ultraviolet, and gamma rays. **Laser** is an acronym for “light amplification by stimulated emission of radiation.” Light, therefore, is a type of electromagnetic radiation. Light is made up of tiny packets of energy called photons. The amount of energy is what determines the wavelength. Lasers are usually infrared (1 mm to 750 nm) and visible light (750- to 400-nm wavelength). Microwaves are mostly high-frequency radio waves (millimeters to centimeters), with wavelengths 10,000 times longer than lasers. Diffraction of any electromagnetic radiation beam is based on the wavelength and aperture size. For the same aperture size, lasers diffract 10,000 times less than microwaves. This allows the beam to reach farther ranges while maintaining a small spot size of concentrated energy on the target. Lasers are preferred in specific scenarios because of minimal diffraction. The electromagnetic spectrum is shown in Figure 1.

LASER FUNDAMENTALS

The quantum mechanical idea of stimulated emission of light was discovered by Albert Einstein in 1917 and is one of the fundamental ideas behind the laser. Einstein

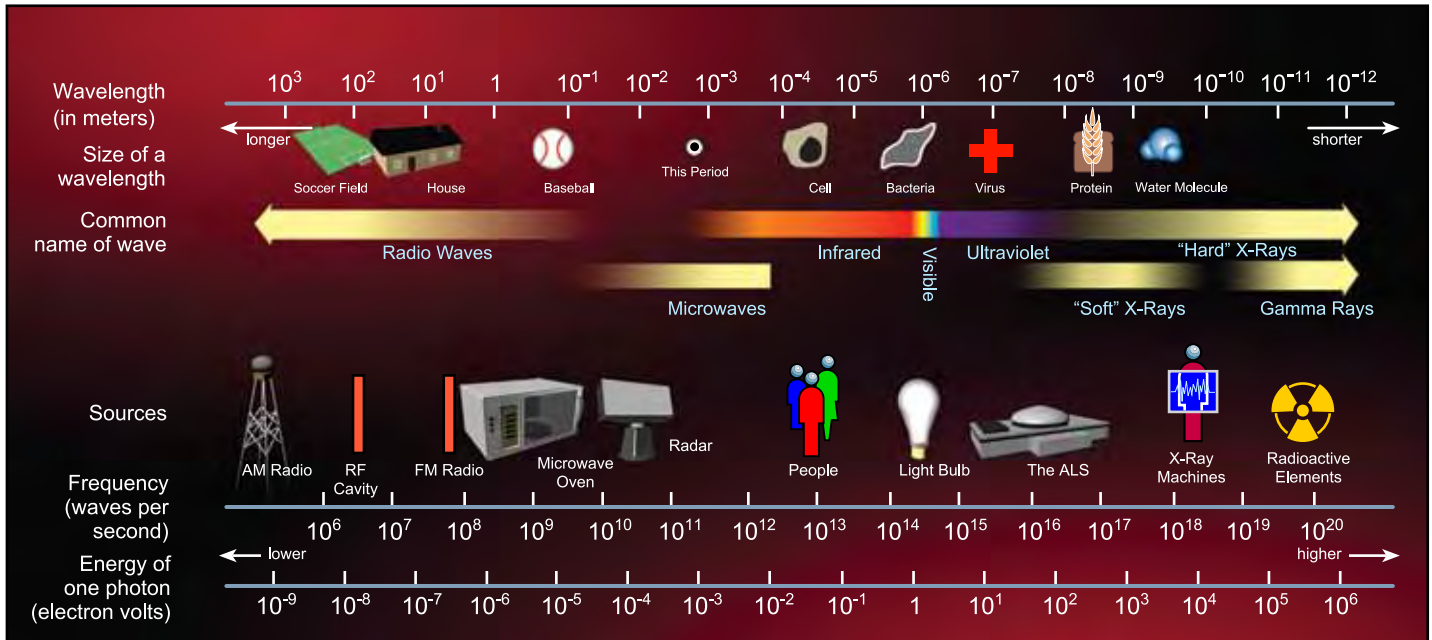

Figure 1. Electromagnetic Spectrum

theorized that when a photon interacts with an atom or molecule in an excited state, two photons are produced when the atom or molecule leaves the excited state. Population inversion occurs when the atoms or molecules are in the excited state. In order for molecules to come out of the normal "ground" state, a source of power must be introduced to the system energizing the atoms to the excited state. When many photons are passed through many excited atoms, more and more photons are produced. The photons are contained and reflected back and forth in a cavity, with mirrors usually on each end. The mirror on the output end is only partially reflective, allowing some photons to leak through, creating the laser beam.

The difference between an everyday light bulb and the light of a laser is temporal and spatial coherence. In a light bulb, the light emits photons equally in all directions. The light is random, out of phase, and multiwavelength. A laser emits coherent light, so photons travel in identical direction and phase. A laser is also monochromatic, i.e., light of one wavelength. Another significant difference is that laser light is highly collimated, which means the laser beam can travel long distances with minimum spreading.

The laser gain medium through which the photons travel to become amplified or magnified can vary. The source of power used to excite the medium, achieving population inversion, can be the result of a chemical reaction, an electric discharge,

a flash lamp, another laser, or some other excitation mechanism. The type of the lasing medium determines the type of laser. The three categories in which lasers are usually classified are chemical, gas, and solid state. A laser can also be continuous wave (CW) or pulsed. Each type of laser produces a specific wavelength of radiation. It is important to note that different wavelengths of radiation interact with the atmosphere differently. A laser beam is either scattered or absorbed by air molecules, water vapor, or dust. Longer wavelengths scatter less and are absorbed more than shorter wavelengths; our sky is blue because the shorter blue wavelengths of light are scattered more than the longer wavelengths.¹ Gamma rays are so highly absorbed that they cannot propagate more than a few feet in the air. Thus, some laser wavelengths are scattered or absorbed more than others. This makes laser wavelengths with minimum absorption better for use as directed-energy weapons since they propagate through the atmosphere better than others. For example, the carbon-dioxide (CO_2) laser is strongly absorbed by water vapor, so any use near the ocean will be negatively affected. Near-infrared and infrared lasers have shorter wavelengths with negligible absorbance. The optimal laser choice, therefore, would be a wavelength-tunable laser that could vary depending on the atmospheric conditions, such as the free-electron laser (FEL).

Lasers have affected almost every type of modern technology. Most laser technologies use low

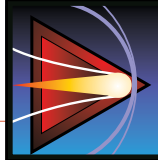

powers and were mastered very quickly. They are used in many everyday appliances, such as scanning/inventory devices, surgery/medicine, hair removal, presentation pointers, law enforcement, ranging and sighting devices, welding applications, and much more. Using a laser as a weapon has many advantages. For example, a laser:

- Is unaffected by gravity
- Causes minimal collateral damage
- Travels at the speed of light
- Can precisely reach far distances
- Is capable of causing a specific, predetermined amount of damage to targets

The theory behind these capabilities makes the laser weapon a prime choice in multiple engagement scenarios. However, developing lasers with higher powers to use as a weapon has proven more difficult than first considered.

MILITARY LASER HISTORY AND LASER TYPES

Generally, a laser weapon is any laser used against the enemy with more than 50 kW to megawatts of power. This is much greater power than commercial lasers. Accordingly, they have greater support needs, including:

- Environmental and personnel safety
- Mirror coatings
- Chilling requirements
- Power requirements
- Laser fuel storage
- Alignment and tracking requirements

In 1960, the very first laser (a ruby laser) was built, producing minimal power. This event was followed by many other laser technology developments. The first chemical laser, hydrogen fluoride (HF), was built in 1965, producing 1 kW. It was then that DoD became interested in researching and developing a more powerful laser for weapon applications. Subsequently, in 1968, the Defense Advanced Research Projects Agency (DARPA) Baseline Demonstration Laser produced 100 kW, and the Navy-ARPA Chemical Laser (NACL) produced 250 kW in 1975. The very first laser is depicted in Figure 2.

Solid-State Lasers (SSLs)

An SSL uses a solid lasing medium, such as a rod made up of glass or crystal, or a gem, like the ruby laser. Along with the rod or host material is an active material, such as chromium, neodymium, erbium, holmium, or titanium. Chromium is the active material used in ruby lasers. Neodymium is the active material in the most widespread applications. A flash lamp, arc lamp, or another laser carries out the optical cavity pumping to achieve population inversion and stimulate the laser beam. The Neodymium Yttrium-aluminum garnet (Nd:YAG) laser is a popular SSL. It operates at a 1064.5-nm wavelength and can be pulsed wave or CW. A great advantage of these lasers is that the wavelength and pulse duration can be varied considerably.¹ The power level can reach up to megawatts when using Q-switching to achieve

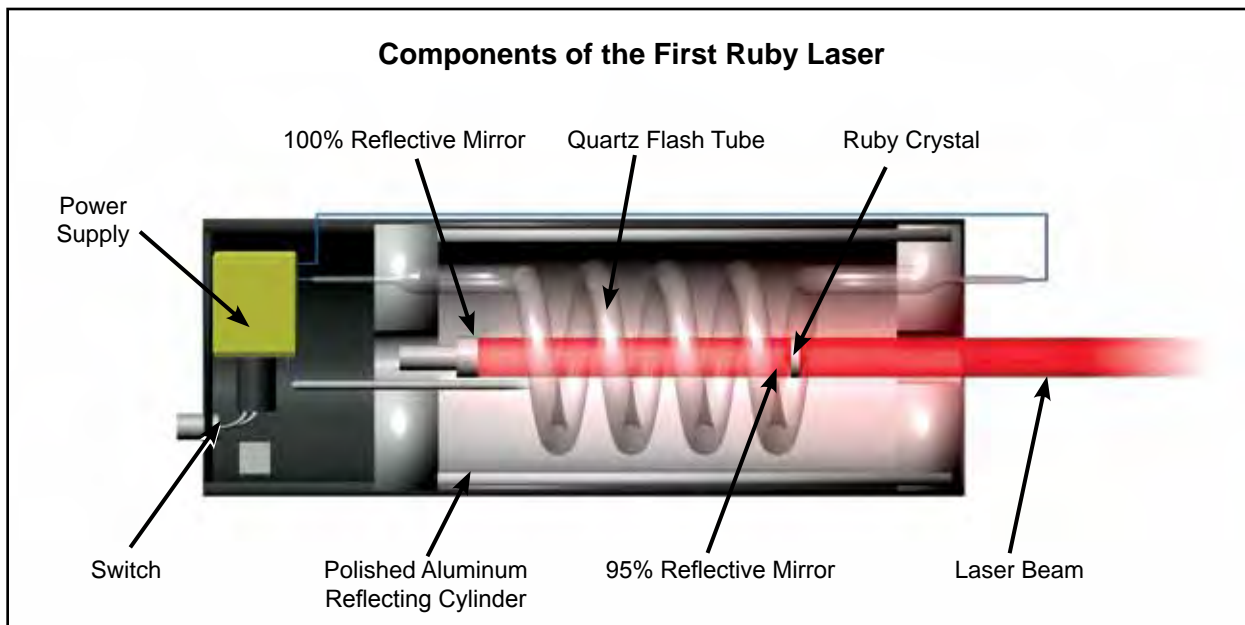

Figure 2. First Ruby Laser Developed in 1960 by Research Physicist Theodore H. Maiman

short pulse lengths. The various interactions with the laser and different crystalline materials can double the electromagnetic frequency, which will halve the wavelength, bringing the laser beam into the visible range, 532 nm (green). The wavelength can be further divided down three or four times, making this laser range from the near-infrared to the ultraviolet wavelength. These lasers are commonly used for rangefinders and target designators. Other advantages of these lasers are that they can be made very small, rugged, cheap, and battery-powered. Characteristics of SSLs are shown in Table 1.

Chemical Lasers

A chemical laser uses chemical reaction to create population inversion in the lasing medium. One example is the Mid-Infrared Advanced Chemical Laser (MIRACL) developed in the mid-1980s. The MIRACL is a continuous-wave, mid-infrared (3.8- μ) laser. Its operation is similar to a rocket engine in which a fuel (ethylene, C₂H₄) is burned with an oxidizer (nitrogen trifluoride, NF₃).² Free, excited fluorine atoms are among the combustion products. Just downstream from the combustor, deuterium and helium are injected into the exhaust. Deuterium (U) combines with the excited fluorine to create excited deuterium fluoride (DF) molecules, while the helium stabilizes the reaction and controls the temperature.² The laser's resonator mirrors are wrapped around the excited exhaust gas, and optical energy is extracted. The cavity is actively cooled and can be run until the fuel supply is exhausted. The laser's megawatt-class output power can be varied over a wide range by altering the fuel flow rates and mixture. The laser beam in the resonator is approximately 21-cm high and 3-cm wide. Beam-shaping optics are used to produce a 14- × 14-cm (5.5- × 5.5-inch) square, which is then propagated through the rest of the beam train. Diagnostics for evaluating the beam shape, absolute power,

and intensity profile are used on each firing of the laser. The beam can be directed to a number of different test areas or to the SEA LITE beam director.² The DF Chemical Laser (MIRACL) and the Sea Lite Beam are shown in Figure 3.

The laser and beam director were integrated in the mid-1980s at the Army's High Energy Laser Systems Test Facility (HELSTF) at White Sands Missile Range, New Mexico. Following integration, extensive tests were conducted in the areas of:

- High-power optical components and beam-path conditioning
- Beam-control techniques
- High-power propagation
- Target damage and vulnerability
- Target lethality³

Tests supported by the MIRACL included:

- The high-power dynamic with flying drone (BQM-34)
- Conventional defense initiative with flying drone
- High-velocity target test with Vandal Missile
- High-altitude target tests with flying drone
- Missile and plume tests using the 1.5-m aperture
- Radiometrically calibrated images and spectral radiometry

These successful tests are what made many believe that MIRACL was the first and only successful laser weapon system developed by the Navy prior to the Navy Laser Weapon System (LaWS).³

Gas Lasers

Gas lasers are a type of chemical laser that uses a pure gas or gas mixture to produce a beam. The typical gas laser contains a tube with mirrors on each end. One end transmits the beam out of the cavity. Most gas lasers use electron-collision pumping, with electric current passing through the gas. Some use optical pumping with flash lamps. The helium

Table 1. Characteristics of Solid-State Lasers

Name	Wavelength (nm)	Typical Power	Typical Operation
Alexandrite	700-830	5 watts	Pulsed/CW tunable
Erbium	850/1230/1540/1730/2900	8 watts	Pulsed
Holmium: glass	1950	milliwatts	Pulsed
Neodymium	1064/1123/1318/1370	megawatts	Pulsed
Neodymium: glass	1060	megawatts	Pulsed
Neodymium: YAG	1064.5	megawatts	Pulsed/CW
Ruby	694.3	10–15 watts	Pulsed
Titanium-sapphire	660–1060	15 watts	Pulsed/CW tunable

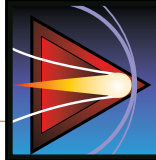

DF Chemical Laser (MIRACL)



Sea Lite Beam

Figure 3. DF Chemical Laser (MIRACL) and Sea Lite Beam

neon (HeNe) laser is a very well-known gas laser. It produces a bright red, continuous beam of low power. It is used for many applications such as scanning, alignment, measurement, and stabilization devices. University students use them in optical training laboratories. Many larger lasers contain a HeNe inside the beam path, as well to verify beam alignment. HeNe lasers are fairly cheap and very rugged. They can work continuously for thousands of hours.

CO₂ lasers are in the gas family. These lasers were the earliest, truly high-power lasers and have been among the most crucial lasers used in R&D for high-energy laser (HEL) weapons. In industry, the more powerful CO₂ lasers are used for welding, drilling, and cutting. There are many different types of CO₂ lasers that vary in pumping design. CO₂ lasers work by burning a hydrocarbon fuel (like kerosene or methane) in oxygen or nitrous oxide. The hot gas flows through a comb of nozzles, expands quickly, and achieves population inversion. The gas then flows through an optical resonator at supersonic speeds, resulting in stimulated emission and a laser beam.⁴

CO₂ lasers have been researched for use as nonlethal weapons. The wavelength produced by a CO₂ laser is also absorbed by glass. For example, the beam does not penetrate a windshield. Thus, shooting a CO₂ laser at a vehicle's windshield could deter a threat by damaging the windshield or by causing a dazzling effect to reduce the visibility of the driver, while not reaching the driver at all.

The gas dynamic laser (GDL) is a CO₂ laser based on differences in relaxation velocities of molecular vibrational states. The laser medium's gas has properties such that an energetically lower vibrational state relaxes faster than a higher vibrational state; thus, a population inversion is achieved in a particular time. A GDL is shown in Figure 4. Characteristics of chemical and gas lasers are identified in Table 2.

Fiber Lasers

Modern fiber lasers are considered SSLs. They are powered by electricity, making them highly mobile and supportable on the battlefield. Fiber lasers use optical fibers as the gain media. In most cases, the gain medium is a fiber doped with rare earth elements—such as erbium (Er³⁺), neodymium (Nd³⁺), ytterbium (Yb³⁺), thulium (Tm³⁺), or praseodymium (Pr³⁺)—and one or several laser diodes are used for pumping. Optical fibers have been used in industry, specifically for telecommunications to transport information via light. With developing technology, optical fibers have become high-energy, powerful laser energy sources. Fiber lasers have proven to have much benefit over traditional SSLs. They are rugged and do not require a clean room to operate or maintain, as most other laser systems do. They also are extremely efficient; however, they cannot operate well in all weather conditions. One example is the IPG CW fiber lasers, which produce moderate beam quality, causing damage to materials and components through thermal heating and burn-through. The Naval Surface Warfare Center, Dahlgren Division (NSWCDD) purchased eight commercially available 5.5-kW IPG lasers, where two multimode (seven fibers) lasers are housed per cabinet. This type of laser is easy to mount due to the flexible fibers. The IPG CW Fiber Laser is shown in Figure 5.

Miscellaneous Lasers

There are other types of lasers that do not necessarily fit into the chemical or solid-state categories. These include semiconductor lasers, used in:

- Television
- CD Players
- Dye Lasers
- Spectroscopy
- Radios
- Telecommunications
- Medicine
- Astronomy

There also are the FELs mentioned previously. The FEL is a completely different breed of laser.



Figure 4. A laser engineer inspects a gas dynamic laser after installation aboard an NKC-135 airborne laser laboratory.

Table 2. Characteristics of Chemical/Gas Lasers

Name	Wavelength (nm)	Typical Power	Typical Operation
Helium-Neon	543/632.8	.0001-.001 watts	CW
Krypton	350-647	.0001-.05 watts	CW
Argon	350-514.5	.001-6.0 watts	CW
Xenon fluoride (excimer)	351	.001-20 watts	CW
Argon fluoride (excimer)	193	.05-30 watts	Pulsed
Krypton fluoride (excimer)	249	7-100 watts	Pulsed
Deuterium fluoride (chemical)	3,000-4,200	.01-100 megawatts	Pulsed/CW
Hydrogen fluoride (chemical)	2,600-3,000	.01-150 megawatts	Pulsed/CW
Carbon dioxide	9,000-12,000	.1-15,000 megawatts	Pulsed/CW
GaAlAs (semiconductor)	750-900	10-4,000 milliwatts	Pulsed



Figure 5. IPG CW Fiber Laser System

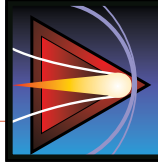

It uses electrons to create photons instead of some type of matter. The electrons are produced, collected, and directed to flow at very high speeds. To excite the electrons, they are passed through a “wiggler,” i.e., a series of magnets positioned in such a way that electromagnetic radiation (light) is produced when the electrons release photons. The significant feature of the FEL is that the wavelength can be controlled, depending on the magnet positions and the speed of electrons. This versatility makes the FEL particularly appealing. However, the footprint of the FEL system is too large to transform into any ideal defense weapon. The Jefferson Laboratory in Newport News, Virginia, has an FEL and continues to maintain and test its capabilities and effects. This laser was new to the military in the late 1990s and received funding to optimize its capabilities and integrate as a defense weapon. Although great progress has been made, the required footprint could be much larger than desired. Consequently, some interest in the FEL has shifted to other HEL sources.

Many scientists foresee the probability of using the laser as a global weapon. This possibility is proven through basic laws of physics. Actually implementing such a system, however, can be more difficult. The global weapon concept uses a base laser with optics and is strategically positioned in space to be able to direct its beam multiple places on Earth at the speed of light with maximum power levels. This idea faces significant problems, including appropriate power levels, optics to handle such levels, propagation issues, and the ethical measures behind any global weapon. Still, the idea presents interesting possibilities.

LASER WEAPON DEVELOPMENT

The following paragraphs highlight some of the laser weapons that have been successfully developed over the last 40 years.

Baseline Demonstrator Laser (BDL) Hydrogen Fluoride (HF)

In 1973, TRW Inc. produced the world's first high-energy chemical laser, the Baseline Demonstrator Laser, for DoD. After that, TRW Inc. produced and demonstrated six more HELs, including the MIRACL (1985) and Alpha (2000), the nation's only megawatt-class chemical lasers.

Navy-ARPA Chemical Laser (NACL) HF

The NACL was mated with the Navy Pointer Tracker at TRW Inc.'s San Juan Capistrano, California, facilities in the 1975–1978 time frame. This was the Navy's initial, integrated HEL system test

bed and was used to provide the first demonstrated kill of an operational missile in 1978.

Alpha HF—Built for Strategic Defense Initiative (SDI) Space-Based Laser (SBL)

Alpha, an HF laser, was the baseline technology for the SBL readiness demonstration (SBLRD). In 1991, the Alpha laser demonstrated megawatt-class power levels similar to MIRACL, but in a low-pressure, space operation environment. Alpha demonstrated that multimewatt, space-compatible lasers can be built and operated.

Tactical High-Energy Laser (THEL)

The THEL is a DF chemical laser developed by the Army. In 2000 and 2001, THEL shot down 28 Katyusha artillery rockets and 5 artillery shells. On 4 November 2002, THEL shot down an incoming artillery shell and a mobile version successfully completed testing. Subsequently, during a test conducted on 24 August 2004, the system successfully shot down multiple mortar rounds. These tests represented actual mortar threat scenarios in which both single mortar rounds and salvo were tested and intercepted. A photograph of THEL is shown in Figure 6.

Advanced Tactical Laser (ATL)

The ATL uses a closed-cycle, chemical oxygen-iodine laser (COIL) with beam control, which lases at a 1.315- μ wavelength. The ATL was developed to engage tactical targets from a moving platform at ranges of approximately 10 km. It can spot a 10-cm-wide beam on a distant target for up to 100 shots. This beam has enough power to slice through metal at a distance of 9 miles. The aircraft equipped with the ATL weapon system is shown in Figure 7.

A specially modified 46th Test Wing NC-130H aircraft equipped with the ATL weapon system fired its laser while flying over White Sands Missile Range, New Mexico, successfully hitting a target board located on the ground. Equipped with a chemical laser, a beam control system, sensors, and weapon-system consoles, the ATL is designed to damage, disable, or destroy targets with little or no collateral damage.

Airborne Laser (ABL) (CO₂) Chemical Oxygen

The ABL C-130H aircraft contains three laser beam systems: the powerful killing primary laser beam (ATL), a set of illuminating laser beams for infrared surveillance and high-speed target acquisition, and a beacon laser for a high-precision laser target tracking beam control system. The primary



Figure 6. Tactical High-Energy Laser (THEL)



Figure 7. 46th Test Wing NC-130H Aircraft Equipped with the ATL Weapon System

laser beam is generated by a megawatt COIL located at the rear of the fuselage. The high-power laser beam travels towards the front of the aircraft through a pipe. The pipe passes through a Station 1000 bulkhead/airlock, which separates the rear fuselage from the forward cabins. The high-power beam passes through the fine beam control system mounted on a vibration-isolated optical bench. Beam pointing is achieved with very fast, lightweight steering mirrors, which are tilted to follow the target missile. The ABL finally destroyed a target while in flight at White Sands Missile Range in August 2009. The 12,000-lb ABL locked onto an unspecified ground target and fired the laser, making the target disappear. Although it was successful at

this demonstration, using the ABL in the fleet has fallen out of favor due to affordability and technology problems. The ABL is shown on an aircraft in Figure 8.

Joint High-Power Solid-State Laser (JHPSSL)

In hopes of accelerating SSL technology for military uses, work is being performed by the U.S. Army Space and Missile Defense Command (SMDC) and the Army Test and Engineering Center at White Sands Missile Range. The technology uses an electric laser diode to shoot light into 32 garnet crystal modules that combine to create “laser amplifier chains” producing 15 kW. By using seven chains and by combining multiple beams, they have reached 105 kW in the laboratory operating in a clean room. The program’s ultimate goal is for a laser system to reach high powers outside a laboratory environment. Fielding such a delicate optical structure can present significant barriers for this laser system. Nonetheless, it will be a great accomplishment for a variety of force protection missions, such as shipboard defense against cruise missiles. The JHPSSL system is shown in Figure 9.

Navy Laser Weapon System (LaWS)

The Navy LaWS is the most recent, successful laser weapon. It uses an electric-fiber laser design, avoiding the problems that chemical lasers present. In the summer of 2009, the Naval Sea Systems Command (NAVSEA)—with support from NSWCDD—successfully tracked, engaged, and destroyed unmanned aerial vehicles (UAV)

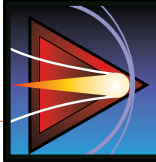

Figure 8. Airborne Laser (ABL)



Figure 9. Joint High-Power Solid-State Laser (JHPSSL) System

in flight at the Naval Air Warfare Center, China Lake, California. A total of five targets were engaged and destroyed during the testing, which represented a first for the U.S. Navy. The laser was fired through a beam director on a Kineto Tracking Mount similar to the Sea Lite beam director. The system used fiber lasers in the configuration and has proven to be a rugged and dependable choice for the warfighter's needs. A photograph of LaWS is shown in Figure 10.

Laser weapon systems development in recent years has taken giant steps forward. Dedicated R&D has advanced the state of the art considerably. What was unimaginable only a few short years ago, today has become reality. Accordingly, given continued R&D, warfighters in the near term will have additional weapon options to

choose from for dealing with a spectrum of threats and contingencies.

REFERENCES

1. Beason, Doug Ph.D., *The E-Bomb: How America's New Directed Energy Weapons Will Change The Way Future Wars Will Be Fought*, Da Capo Press, 2005.
2. Pike John, *Mid-Infrared Advanced Chemical Laser (MIRACL)*, FAS Space Policy Project, Military Space Programs, March 1998, <http://www.fas.org/spp/military/program/asat/miracl.htm>
3. Albertine, John R., "History of Navy HEL Technology Development and Systems Testing," (Proceedings Paper), *Proc. SPIE*, Vol. 4632, Laser and Beam Control Technologies, Santanu Basu and James F. Riker, Eds., pp. 32–37.
4. Anderberg, Major General Bengt and Dr. Myron L. Wolbarsht, *Laser Weapons: The Dawn of a New Military Age*, Plenum Press, New York, 1992.



Figure 10. Navy Laser Weapon System (LaWS)



LASER WEAPON SYSTEM (LAWS) ADJUNCT TO THE CLOSE-IN WEAPON SYSTEM (CIWS)

By Robin Staton and Robert Pawlak



The Naval Sea Systems Command (NAVSEA) established the Navy Directed Energy Weapons Program Office in January 2002 and subsequently chartered the Directed Energy and Electric Weapon Systems Program Office (PMS 405) in July 2004.^{1,2} Its mission is to change the way the Navy fights in the 21st century by transitioning directed-energy and electric weapon technology, providing the warfighter with additional tools to fight today's and tomorrow's wars. In support of this mission, the Laser Weapon System (LaWS) was developed, which potentially adds a suite of tools for offensive and defensive operations.

The LaWS program is managed by PMS 405 in cooperation with the Program Executive Office Integrated Warfare Systems (PEO IWS), the Navy's Close-In Weapon System (CIWS) manager. A multilaboratory/multicontractor organization led by the Naval Surface Warfare Center, Dahlgren Division (NSWCDD), has been executing the program since March 2007. The potential advantages of a lethal, precise, speed-of-light weapon are numerous and have been recognized for many years. However, even in light of these advantages, there are realities that need to be considered for any program to succeed to the point that an actual system is placed in the hands of the warfighters.

The LaWS system offers viable solutions for an important subset of threats while fitting into acceptable size and weight constraints. In addition, since LaWS is a fully electric laser, the operation of the system does not require the handling and storage of hazardous chemicals, such as hydrogen fluoride. As will be discussed later, due to the incorporation of high levels of commercial off-the-shelf (COTS) technology, the LaWS system also has advantages for topside design, logistic supportability, and cost. Thus, LaWS could enable the Navy to address adverse cost-exchange situations, which can occur when engaging proliferated inexpensive threats such as unmanned aerial vehicles (UAVs).

BACKGROUND

Based on mission analysis work conducted prior to the LaWS program and additional work done as part of the program, it became clear that a number of factors require careful consideration. First, a high-power laser is not likely to replace anything on a ship in the next 5 years. For a new system to be added to a ship, a high-power laser must supplement current capabilities or provide new capabilities that clearly justify its addition. Second, because a laser provides such a diverse set of capabilities, conventional air-to-air warfare (AAW) models—

such as the Fleet AAW Model for Comparison of Tactical Systems (FACTS), Antiair Warfare Simulation (AAWSIM), and Extended Air Defense Simulation (EADSIM), as well as other existing AAW analysis approaches—are not well suited for showcasing current or near-term laser-weapon capabilities. While they can (and have) been used for laser-weapon analysis, their application to a megawatt-class laser that could “instantly” destroy boats or cruise missiles (akin to missile engagements) is a more straightforward application of the existing models and techniques.

In November 1995, the Chief of Naval Operations requested that the National Research Council initiate, through its Naval Studies Board, a thorough examination of the impact of advancing technology on the form and capability of the naval forces to the year 2035. A major observation of the report is quoted below:

Numerous laboratory and field-test versions of laser weapons have been developed and demonstrated. They have worked as expected and demonstrated suitable lethality against their intended targets. The primary factors that have inhibited the transition of the technology into deployed systems are size and weight. Generally, the conceptual designs of laser weapons that are scaled for combat effectiveness are too large to be appealing to users; conversely, weapons that are sized for platform convenience generally lack convincing lethality.³

Subsequently, an August 2006 U.S. Air Force (USAF) Scientific Advisory Board Study examined the increasing threat posed by UAVs in some detail. Key conclusions included:

No single system can completely address the UAV threat. A single sensor solution is inadequate because of the size and speed challenges presented by small UAVs. A single-weapon-layer solution fails to provide for adaptability to multiple scenarios or adequate probability of kill.

Key recommendations of the USAF Advisory Scientific Board Study included:

Develop and field longer-term upgrades to counter increased UAV threats. They include...a small, multimission air/air and air/ground weapon; and directed-energy air defense weaponry.⁴

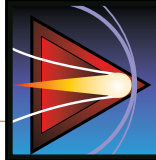

In addition to the USAF Scientific Advisory Board study, a 2007 OPNAV Deep Blue Study noted the potential advantage of nonkinetic defeat options and recommended that the Navy accelerate development of nonkinetic systems to include high-energy lasers (HELs).⁵

The laser power levels likely to be available in the near term, within reasonable size and cost, are in the neighborhood of 100 kW of radiated power. While this power level is not adequate to engage certain threats, such as cruise missiles or tactical ballistic missiles at tactically useful ranges, there is still a wide spectrum of threats that could be engaged at ranges that are comparable to many current ship-defense weapons, including minor-caliber guns and small missiles. The spectrum of threats includes:

- UAVs
- Missile Seekers
- Intelligence, Surveillance, and Reconnaissance Systems
- Rockets
- Man-Portable Air-Defense Systems (MANPADS)
- Mortar Rounds
- Floating Mines
- Artillery Rounds

LAWS ON CIWS

The Mk 15 Phalanx CIWS can often detect, track, and (sometimes) identify potential threats at ranges well outside the effective range of the 20mm gun. These functions are accomplished using the search/track radar system and the Phalanx Thermal Imager (PTI). When added to the Phalanx mount and pointed in the same direction as the gun (see Figure 1), a laser weapon could potentially add a number of useful functions and capabilities to the mount, but technical challenges must be overcome. Preliminary analyses of the mechanical characteristics of the mount suggest that the additional weight that could be added to the mount must be kept under approximately 1200–1500 lb. Additionally, it is highly desirable that the addition of the laser weapon not substantially affect the train/elevation operation of the mount in angle, peak velocity, or acceleration. Consequently, use of rapidly evolving fiber laser technology appears to be the only currently foreseeable path to adding significant laser energy directly to the mount within these constraints.

One major driver in the genesis of the LaWS system was the availability of relatively

low-cost COTS fiber-optic lasers. Because these fibers are flexible, they obviate the need for an expensive coude path system (an optical mirror/lens assembly that turns radiation 90° and may also support rotation of the beam director), thus allowing the use of low-cost mount technology, as well as the retrofitting of the system on existing mounts. The last factor is extremely important because of the scarcity of topside real estate on today's ships. These fiber-optic lasers do have limitations in terms of power, although power levels are growing with advancing technology. The reality today is that, in order to get adequate lethality from a system based on this technology, the use of a beam-combining apparatus utilizing several individual fibers is necessary. (Figure 2 depicts combining multiple fibers in the same beam director.) Furthermore, a smaller beam size is desirable since this drives power density up—increasing the performance required for the tracking and pointing elements of the system. Thus, a high-resolution fine track sensor is needed, as well as an appropriately robust line-of-sight control.

A POTENTIAL SUITE OF LAWS-RELATED CAPABILITIES

Potential added capabilities that an adjunct LaWS could contribute to the total ship combat system are briefly outlined in the following subsections.



Figure 1. LaWS Mounted on CIWS

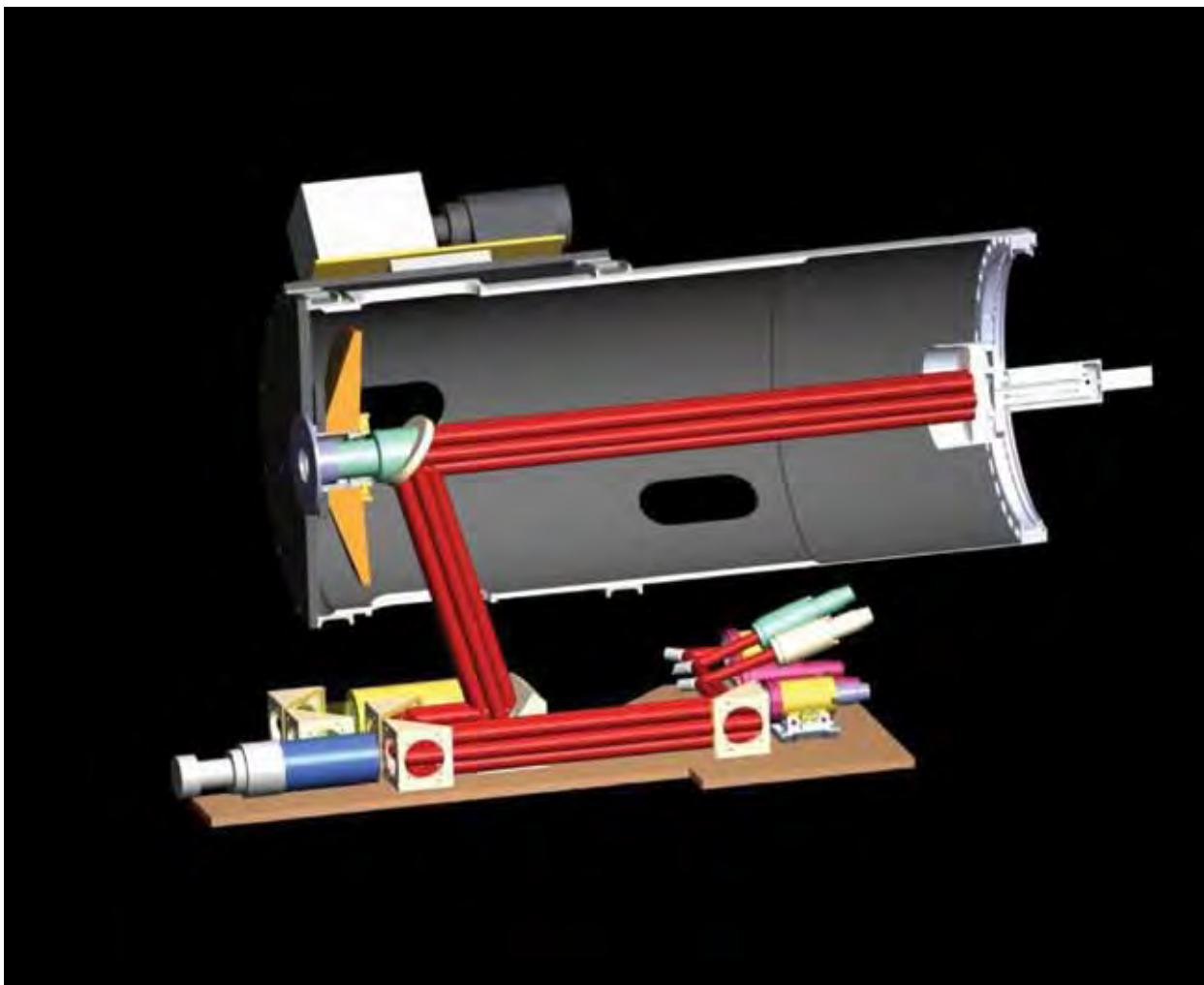

Figure 2. Cutaway View of the LaWS Beam Director

Target Identification, Tracking, and Intent Determination at Range

The optics that would be added for the laser to detect and track targets in support of a laser engagement would immediately contribute additional capabilities to the entire ship combat system even without operating the laser. A laser-gated illuminator, part of the tracking system, significantly increases the signal to the background level of tracked targets and provides good range resolution as well. The additional sensitivity and angle resolution provided by the LaWS optics would allow the identification, precision tracking, and “monitoring” (at high resolution) of potential threats or vehicles of interest at substantially greater ranges than could be achieved by the PTI alone. The Phalanx radar, or another source, would have to provide an initial, accurate cue to facilitate initial acquisition. Once acquired, the target could be examined and monitored with high resolution at range. This capability could

make a substantial contribution to identification efforts—efforts to determine intent and potentially even to documenting target behavior to resolve issues with rules-of-engagement doctrine. It is widely recognized that rules-of-engagement issues, such as threat identification and intent determination, are among the most difficult problems faced by ship commanding officers.

Unambiguous Warning at Range

If a fraction of the laser energy is routed through a frequency-doubling crystal, an intense, visible beam can be projected to significant ranges to provide a clear, unambiguous warning that a potential target is about to be engaged unless an immediate change in behavior is observed. This feature also would have utility for dazzling aircraft, surface vehicle, or submarine sensors, and would provide exceptional long-range, unambiguous warning to boats or aircraft at night.

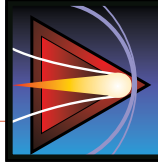

Sensor Destruction at Range

Many electro-optical (EO) sensors are quite susceptible to damage by laser energy in the fiber-laser band as is the case with infrared (IR) missile seekers with germanium optics. The frequency-doubling feature described in the previous paragraph also would be useful to ensure that a band-pass filter at a single frequency could not be applied as an effective countermeasure. The intent here would be to destroy the seeker or imager at ranges well beyond those achievable by the Phalanx 20mm gun. Other examples include intelligence, surveillance, reconnaissance, and targeting sensors on UAVs or unmanned surface vehicles (USVs).

IR Missile Assist at Range

Many targets of interest—including UAVs, USVs, and small boats—are somewhat “marginal” from a target-signature standpoint, particularly at the maximum range of existing IR guided missiles such as the FIM-92 Stinger, the FGM-148 Javelin, the RIM-116 RAM, and the AIM-9X Sidewinder. The CIWS laser adjunct could potentially “correct” this situation by laser heating target vehicles to enhance their signature to existing IR guided missiles. Note that this is NOT “conventional” semiactive-laser (SAL) guidance—the LaWS is not a coded illuminator, nor do the seekers in question rely on this coding. The IR missiles would be unmodified weapons taken from inventory. The LaWS adjunct would simply contribute laser energy that heats the target and enhances its signature for the missile. While, at the ranges envisioned, this laser heating alone would not be sufficient to “kill” the target, it could definitely heat the target. It should also be noted that the laser “illumination” could potentially be used to preferentially select a specific target from among a group of targets for engagement by a missile. It is expected that these engagements could occur at ranges of two to four times the effective Phalanx gun engagement ranges. Use of LaWS in this manner would be exactly analogous to the use of a SAL designator for a SAL guided missile, such as the AGM-114 Hellfire. It is expected that similar rules of engagement would apply.

Direct Target Destruction by Laser Heating

Some threats are known to be vulnerable to direct destruction by the application of laser energy for an appropriate period of time. The currently envisioned system would be able to destroy a subset of naval threats at ranges comparable to, and in some cases greater than, the ranges achieved with modern, stabilized guns using EO fire control systems and modern ammunition. In the case

of a LaWS adjunct, the addition of the laser would open new options for a firing/engagement doctrine and would be expected to conserve CIWS rounds for use on threats that are not appropriate for this laser power level. While the laser is often quoted as having an “unlimited magazine,” the true number of threats that can be engaged by the laser in any period of time is limited by the required illumination time and by the time required to evaluate a kill and transition to the next target. Thus, for particular target velocities and numbers, the “effective laser magazine” might be added to the CIWS magazine to increase the total number of targets engaged by the combined system.

LAWS ACCOMPLISHMENTS

A government/industry team, led by government technical personnel, have achieved significant accomplishments since the start of the LaWS program in 2007; specifically, the team:

- Conducted mission analyses
- Developed threat lethality estimates
- Performed industry surveys for critical components and subsystems
- Performed extensive trade-off analyses
- Designed a prototype system
- Constructed the system—the prototype director and mount (see Figure 3)
- Performed numerous laboratory-based tests of subsystems and the complete prototype
- Validated system operation with a full-up field test at high power using BQM-147A UAV target drones

Additionally, the team was able to minimize the cost of the prototype by leveraging hardware that had already been developed or procured for other applications, including an L3-Brashear tracking mount, a 50-cm telescope, and high-performance IR sensors. Some components were commercially procured, such as the 5.4-kW fiber lasers. Figure 4 shows three laser cabinets, containing two lasers apiece, resulting in a total power output of 32.4 kW. Other components, such as the beam combiner and much of the system software required for operation and target tracking, had to be specifically designed, fabricated, and tested.

The LaWS program achieved a highly successful field test/demonstration in June 2009 when the prototype successfully engaged and destroyed five drone targets at tactically significant ranges at the China Lake, California, test range (see Figure 5).

ADDITIONAL WORK TO BE DONE

Since the LaWS prototype sits on a dedicated gimbal, much additional work needs to be done



Figure 3. Photo of LaWS During Testing at the Naval Weapons Center, China Lake



Figure 4. IPG Laser Cabinets

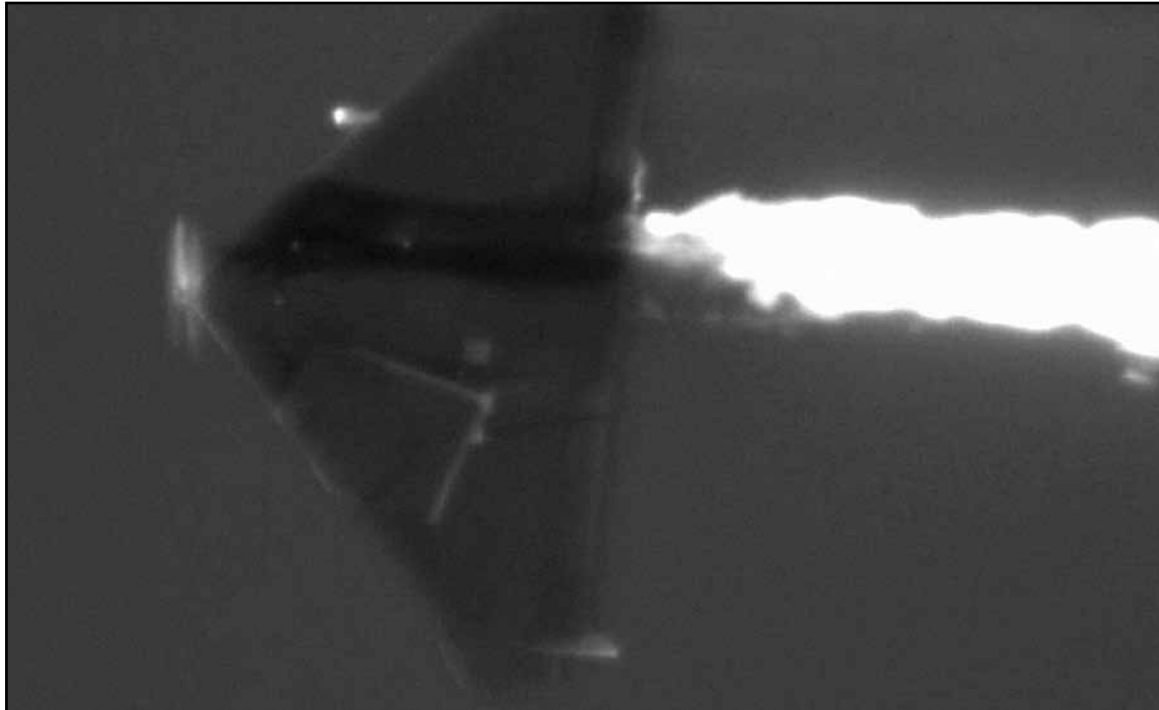

Figure 5. BQM-147A During LaWS Engagement

to place the weapon on the CIWS mount. The latter would require new control systems and optomechanical hardware for line-of-sight stabilization. Other aspects of the shipboard environment are also more stressful, and future mission areas may require an increasingly robust capability to deal with optical turbulence and the high-clutter environment of the ocean surface. Additional laser power might also be required. These modifications, depending on the level of capability desired, will require engineering modifications to the system. Engineering analysis and design to address these issues is currently underway at NSWCDD.

While the aforementioned engineering issues are important to address, there are additional technical issues that have yet to be analyzed. These issues are concerned with the potential utility of the system. Indeed, most of the detailed technical analyses and experiments performed thus far have focused on target destruction, with some effort expended on the issue of seeker damage/destruction. Developing credible lethality estimates for various potential threat targets is clearly very

important, but one consequence of the lethality focus is that necessary, detailed, defensible technical analysis, analytic model development, and experiments have not been performed to explore the other functions/features that a CIWS Adjunct LaWS might provide to the overall ship combat system. Some of these contributions might become “routine” if the LaWS were available.

For example, a hard-kill engagement of a target by a Navy shipboard weapon is a relatively rare event, even during wartime conditions. On the other hand, ships in combat zones—and elsewhere—constantly have the problem of detecting potential threats, tracking them, identifying them, determining their intent, and providing warning. Thus, use of the LaWS system, at less than its full lethal potential, could become a daily, standard practice. It is still not clear how these potential benefits and capabilities could be measured or quantified to the satisfaction of key decision makers.

Likewise, other potential advantages of laser weapons—such as the potential for precision engagement, covert engagement, fire starting, graduated lethality, low cost per shot, and “unlimited”

magazine—have not been subjected to rigorous technical analysis for feasibility, utility, and practicality. These investigations need to be performed and are gradually being addressed within the LaWS program.

Although the Phalanx CIWS system is currently installed on a number of Navy surface warships—either a single mount or a double mount—there are still significant numbers of ships that do not have a Phalanx system. It is highly desirable to make LaWS potentially available to virtually any ship that could benefit from the enhanced capabilities.

While the technical issues associated with the addition of LaWS to the Phalanx CIWS will be somewhat different from those associated with adding a LaWS system to other weapon systems—or the provision of a “stand-alone” LaWS—they do not appear to be insurmountable. For example, a LaWS beam director might be added to the stabilized Mk 38 Mod 2 25mm gun or the Mk 46 Mod 2 30mm gun. A LaWS beam director might be added to (or even substituted for) the Mk 46 EO Sight on DDGs or added to the trainable RAM launcher. Other options may exist as well.

The issue of defending combat logistics force ships, joint sealift ships, and certain support vessels from attacks from small boats or UAVs is also relevant. These ships often have little or no installed defensive capabilities for potential terrorist or pirate threats, and expeditionary security detachments do not have decisive warning or engagement capability. In addition, there are severe limitations placed on concept of operations (CONOPS) and rules of

engagement due to the limited objectives/limited means of the various missions.

A system such as LaWS could provide graduated lethality from warning to destruction. It also could provide additional applications to minimize risk to sea base platforms and enhance sea shield capabilities against nonstate threats. If acceptable rules of engagement can be established, the advantages of graduated lethality might be extended to ships in port or entering/exiting harbors.

While considerable additional work needs to be done to produce a tactical system, the LaWS program’s recent demonstration of capability provides strong evidence that a useful, tactical system could be produced within reasonable cost, volume, weight, and power constraints to provide the warfighter with a suite of additional tools to fight today’s and tomorrow’s wars.

REFERENCES

1. NAVSEA Notice 5400, Ser 09B/240, “Establishment of the Navy Directed Energy Weapons Program Office (PMS 405),” 4 January 2002.
2. NAVSEA Instruction 5400.101, Ser SEA 06/058, “Directed Energy and Electric Weapon Systems Program Office (PMS 405) Charter,” 21 July 2004.
3. *Technology for the United States Navy and Marine Corps 2000–2035: Becoming a 21st-Century Force*, Naval Studies Board, National Research Council, National Academy Press, 1997, Volume 5: Weapons, Chapter 6, “Navy and Marine Corps Applications for Laser Weapons.”
4. *Report on the Air Defense Against Unmanned Vehicles*, USAF Scientific Advisory Board, SAB-TR-06-01, August 2006.
5. “Counter Unmanned Aerial Systems (UAS),” *OPNAV Deep Blue Report 08-01*, August 2007.

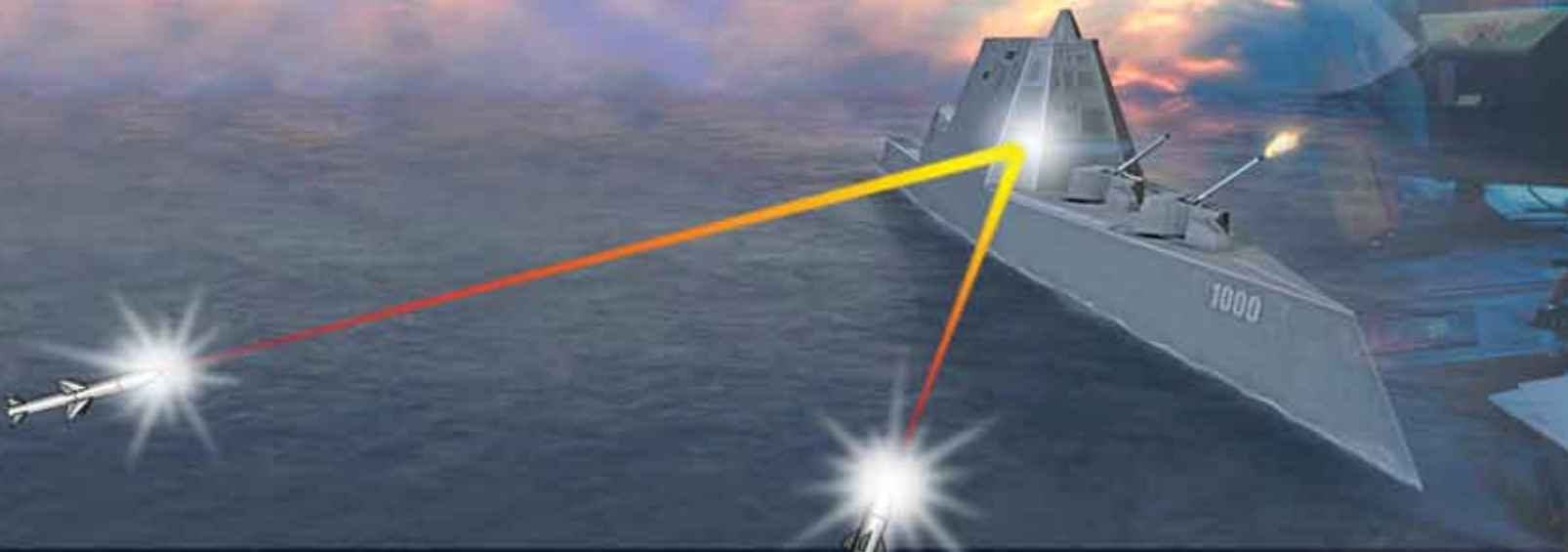
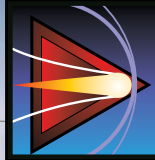

THE ACQUISITION CHALLENGE ASSOCIATED WITH DIRECTED-ENERGY RDT&E

By Mike Kotzian

An already tense situation quickly escalated. Everyone within the combat information center of the Navy's newest all-electric ship suddenly realized that two surface-skimming, antiship missiles were bearing down on their destroyer. With less than 30 seconds to impact, the tactical warfare officer gave the order to fire. Seconds later, the first surface-skimming missile vanished from all tracking consoles. Another order to fire closely followed, and the second missile threat was also destroyed. Consequently, within a matter of 10 seconds from threat recognition to threat elimination, the Navy's newest all-electric ship was able to destroy two incoming threats by using one of the Navy's newest weapon systems—the free-electron laser.

Does this scenario of a Navy all-electric ship, employing a high-energy laser to shoot down enemy surface-skimming antiship missiles, sound like inevitable reality or unattainable science fiction? For scientists and engineers working on directed-energy systems for the Navy, the answer does not lie solely in the advanced technical challenges associated with developing directed-energy weapons. Rather, the answer also lies in how well scientists and engineers understand and adhere to the Department of Defense's (DoD's) Defense Acquisition Management System (DAMS) framework governing the development of new weapon systems.

EVOLUTION OF DEFENSE ACQUISITION

The way in which DoD identifies needs and subsequently develops, tests, procures, and sustains weapon systems has evolved over time. Today's acquisition foundation can be traced back to the Packard Commission report in 1986, where many of this report's recommendations became part of the Goldwater-Nichols DoD Reorganization Act of 1986. This evolution continued along three tracks:

1. Requirements moving from threat-based to capability-based
2. The resource allocation system adding execution reviews with concurrent program and budget reviews

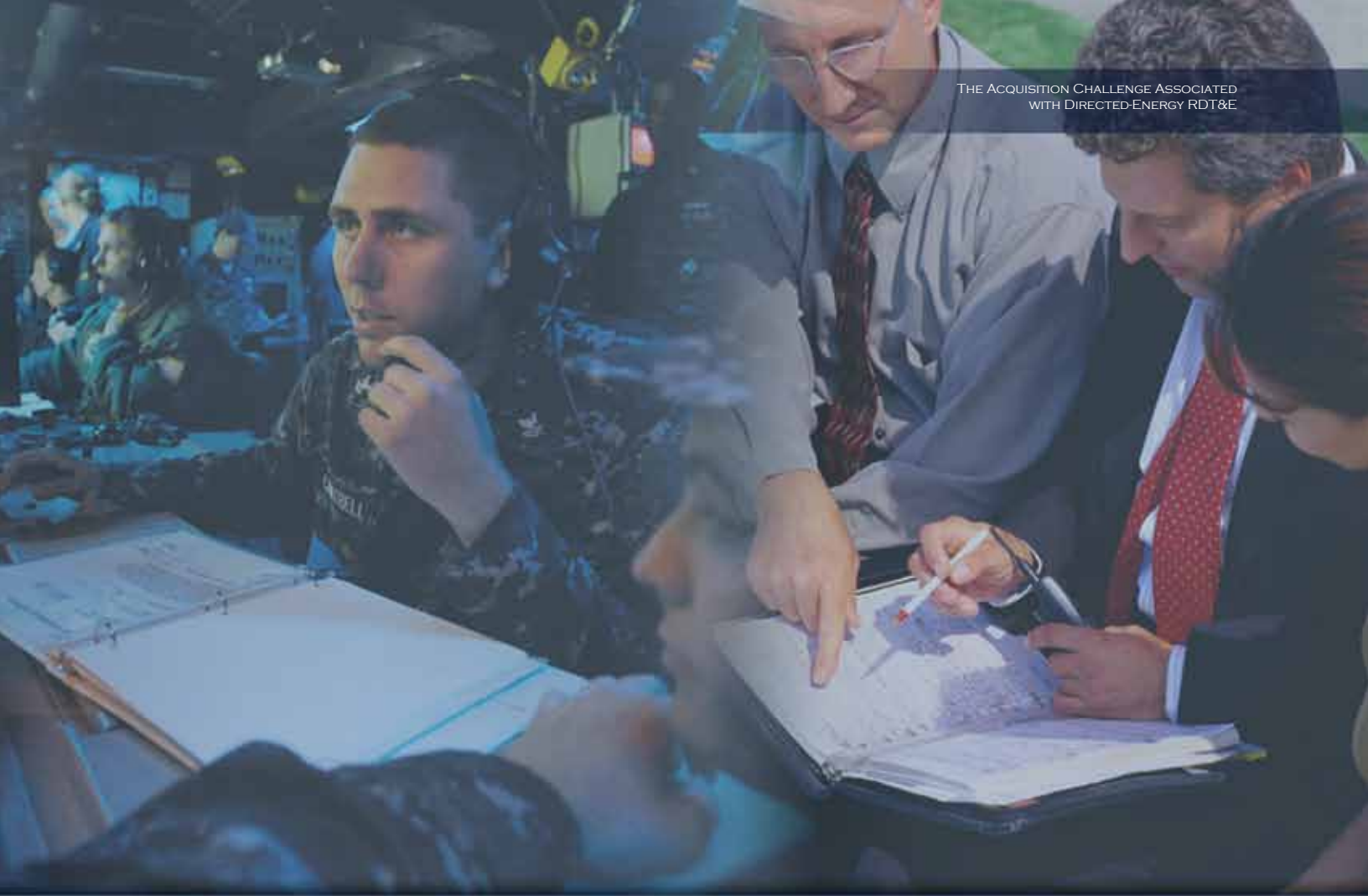

3. The acquisition process attempting to incorporate a more flexible and tailored process. These three tracks form the Defense Support System organizational structure: the Joint Capabilities Integration and Development System (JCIDS) process; the Planning, Programming, Budgeting, and Execution (PPBE) process; and the DAMS process, respectively. These three processes operate as “systems of systems” and are referred to as the “Big A” acquisition process shown in Figure 1.¹

While all three of these phases hold their own level of importance, the major focus for scientists and engineers at research and development (R&D) facilities is the “Little a” acquisition process. It is this “Little a” acquisition process, where the rules and processes are found, that governs how DoD goes about developing a new materiel solution to a validated warfighter requirement. These rules and processes are codified within DoD Instruction 5000.02, *Operation of the Defense Acquisition System*, which was issued in December 2008.

The acquisition framework associated with DoD Instruction 5000.02 is the DAMS structure. This framework, shown in Figure 2, consists of numerous strategically placed milestones and major program reviews to ensure proper programmatic oversight.² Each of the milestones has specific

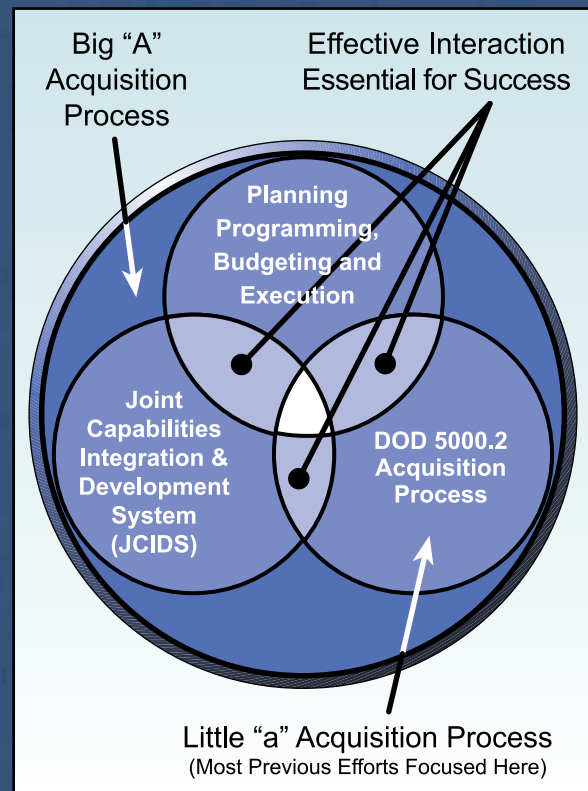

Figure 1. Defense Support System Organizational Structure

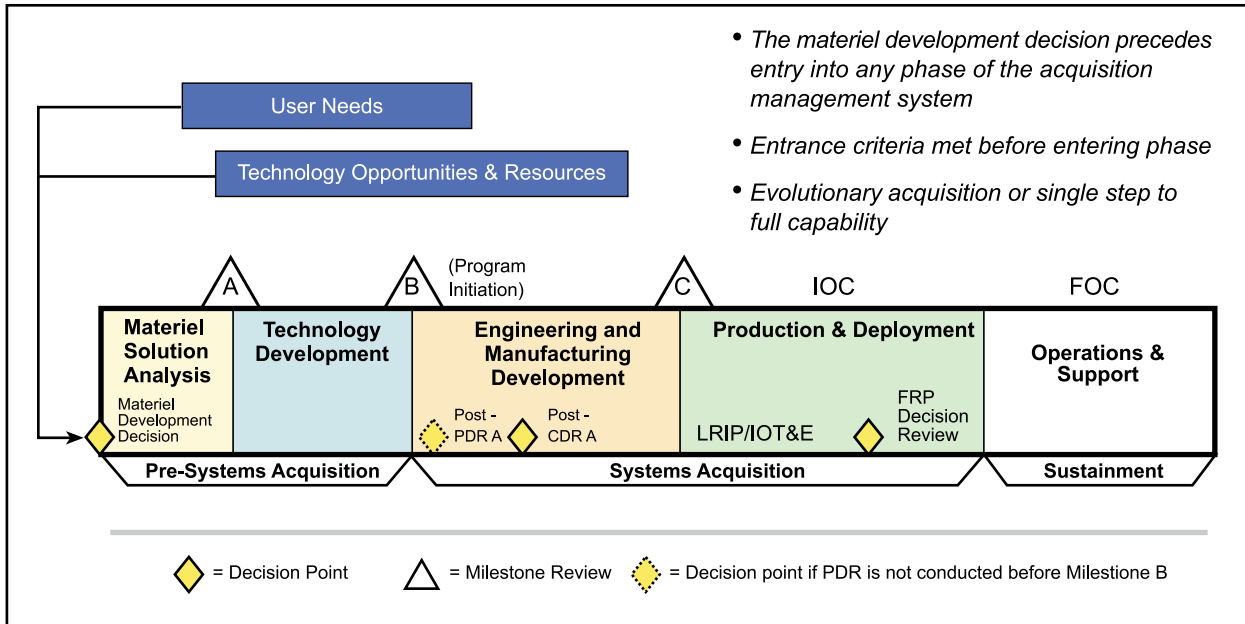
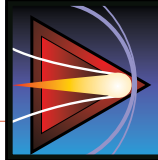

Figure 2. DoD Acquisition Framework

criteria that must be satisfied before a program is allowed to further proceed along the DAMS. The program’s Milestone Decision Authority (MDA) rests with the individual responsible for deciding if the milestone criteria have been met and, if so, for allowing the program to proceed to the next phase of the acquisition process. Designation of a program’s MDA depends on a program’s level of research, development, test, and evaluation (RDT&E) and procurement funding. For example, an Acquisition Category (ACAT) I program is defined as an eventual total expenditure for RDT&E of more than \$365 million in fiscal year (FY) 2000 constant dollars or, for procurement, of more than \$2.19 billion in FY 2000 constant dollars. In this case, for an ACAT ID (“D” refers to the Defense Acquisition Board (DAB)) the Under Secretary of Defense for Acquisition, Technology and Logistics (USD(AT&L)) is the MDA; for an ACAT IC (“C” refers to Component or Service), the MDA is the Head of the DoD Component or, if delegated, the Component Acquisition Executive.³

In addition, civilian and military workforce members within the DoD whose job responsibilities are deemed acquisition-related find themselves with a training requirement necessary to carry out their acquisition-related job responsibilities. Specifically, these workforce members are required to gain acquisition training and education with the passage of the Defense Acquisition Workforce Improvement Act (DAWIA) signed into law in 1990. The current certification process comprises three

levels covering 16 different career fields. Each of these 16 career fields has a set of specific training, education, and experience requirements that must be met in order for an individual to achieve Level 1, Level 2, or Level 3 certification. The Defense Acquisition University (DAU) provides the necessary training classes required for the certification. DAU identifies “core-plus” training classes and continuous learning modules for each level of certification. The core-plus classes and modules are not required for certification but are identified as additional sources of information to assist individuals in becoming more knowledgeable about their career field beyond the minimum standards required for certification. The most up-to-date certification frameworks for all 16 career fields can be found at the following DAU website: <http://icatalog.dau.mil/onlinecatalog/CareerLvl.aspx>

DEFENSE ACQUISITION REFORM

The DoD acquisition environment is undergoing continuous change. The issuance of DoD Instruction 5000.02 marked the opening salvo of what has become seemingly constant updates, modifications, and guidance impacting how DoD procures weapon systems to meet warfighter requirements. In addition to DoD’s issuance of DoD Instruction 5000.02, the Government Accountability Office published a stream of reports and findings that indicate significant cost growth and schedule delays in major defense acquisition programs. In 2009, Secretary of Defense Robert M. Gates proclaimed



a new way of doing business within DoD when it comes to weapon systems acquisition. Pressures are building for every program to maintain cost and schedule estimates while delivering the technical requirements originally developed to support the warfighter.

Moreover, there have been two major policy issuances. As previously mentioned, the first was DoD Instruction 5000.02 in December 2008. This update of the rules and processes governing DoD weapon systems acquisition primarily impacted the early part of the DAMS framework. The problem was that weapon system programs were failing their initial operational test and evaluation phases at alarming rates—many times traced to program offices attempting to design weapon systems with immature technology. Such failures were preventing those programs from proceeding to a full-rate production decision review and, more importantly, causing a repeat of some of the DAMS framework, which translated to increased costs and delayed initial operational capability timelines.

DoD Instruction 5000.02 attempted to solve this problem with three main emphases. First, a mandatory requirement was inserted for competitive prototyping prior to program initiation at Milestone B. The intent was to ensure a competition among contractors competing for a contract award. The theory was that such a competition would reduce technical risk, validate designs, improve cost estimates, evaluate manufacturing processes, and refine requirements. Reducing technical risks was

especially important because weapon system programs were expected to demonstrate a technology readiness level (TRL) of six—where the system/subsystem model or prototype is demonstrated in a relevant environment—by the time a program reached Milestone B. TRLs are categorized on a scale of 1 to 9. A TRL of 1 is the lowest level of technology readiness, where scientific research begins to be translated into applied R&D. A TRL of 9 is the highest level of technology readiness, where the actual system is proven through successful mission operations. A TRL of 6 represents a major step up in a technology's demonstrated readiness. Using TRLs enables consistent comparisons of technical maturity across different types of technologies, giving program decision makers a common benchmark to consider when assessing program risk. Note that TRLs are meant to capture a level of technical maturity, not the probability of occurrence (i.e., the likelihood of attaining a required maturity level) or the impact of not achieving a level of technical maturity.⁴

The second emphasis was on a stricter adherence to systems engineering processes and technical reviews. Too often weapon system programs were not closely following systems engineering processes or avoiding due diligence when it came to the definition of successful exit criteria for a technical review. Consequently, all technical efforts must be outlined in a program's systems engineering plan. The program manager will use the eight technical management processes—decision

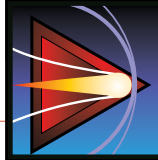

analysis, technical planning, technical assessment, requirements management, risk management, configuration management, technical data management, and interface management—to manage the technical development of the system increments, including the supporting or enabling systems.⁵ The program manager will use the eight technical processes—stakeholders requirements definition, requirements analysis, architectural design, implementation, integration, verification, validation, and transition—to design the system, subsystems, and components, including the supporting or enabling systems required to produce, support, operate, or dispose of a system.⁶ Figure 3 provides an overlay of the new DoD Instruction 5000.02 and Secretary of the Navy (SECNAV Instruction) 5000.2D (Implementation and Operation of the Defense Acquisition System and the JCIDS), and shows the timing of specific systems engineering technical reviews as a program matures through the DAMS.

The third emphasis was a more prominent role of the MDA, starting with a mandatory requirement that all weapon system programs seeking a full or partial materiel solution must hold a Materiel Development Decision chaired by the MDA. Thus, the old Design Readiness Review was replaced with the Post-Critical Design Review Assessment chaired by

the MDA. In short, the MDA was to become a more prominent figure in the oversight of a weapon system program's progress.

The second relatively recent major policy issuance was the Weapon Systems Acquisition Reform Act (WSARA) of 2009, implemented by Directive-Type Memorandum (DTM) 09-027 in December 2009. This DTM amended DoD Instruction 5000.02, the *Defense Federal Acquisition Regulation Supplement (DFARS)*, and associated business practices within the *Defense Acquisition Guidebook (DAG)*. The WSARA implementation brought about changes to policies and procedures across 13 categories. Some of the WSARA changes most relevant to the Navy directed-energy community include:

- Analysis of alternatives study guidance
- Acquisition strategies to ensure competition
- Competitive prototyping
- Developmental test and evaluation
- Systems engineering
- Preliminary design reviews
- Critical cost growth

THE ACQUISITION IMPACT

So why should the directed-energy community care about these acquisition policy changes? Because these policy changes impact the community's

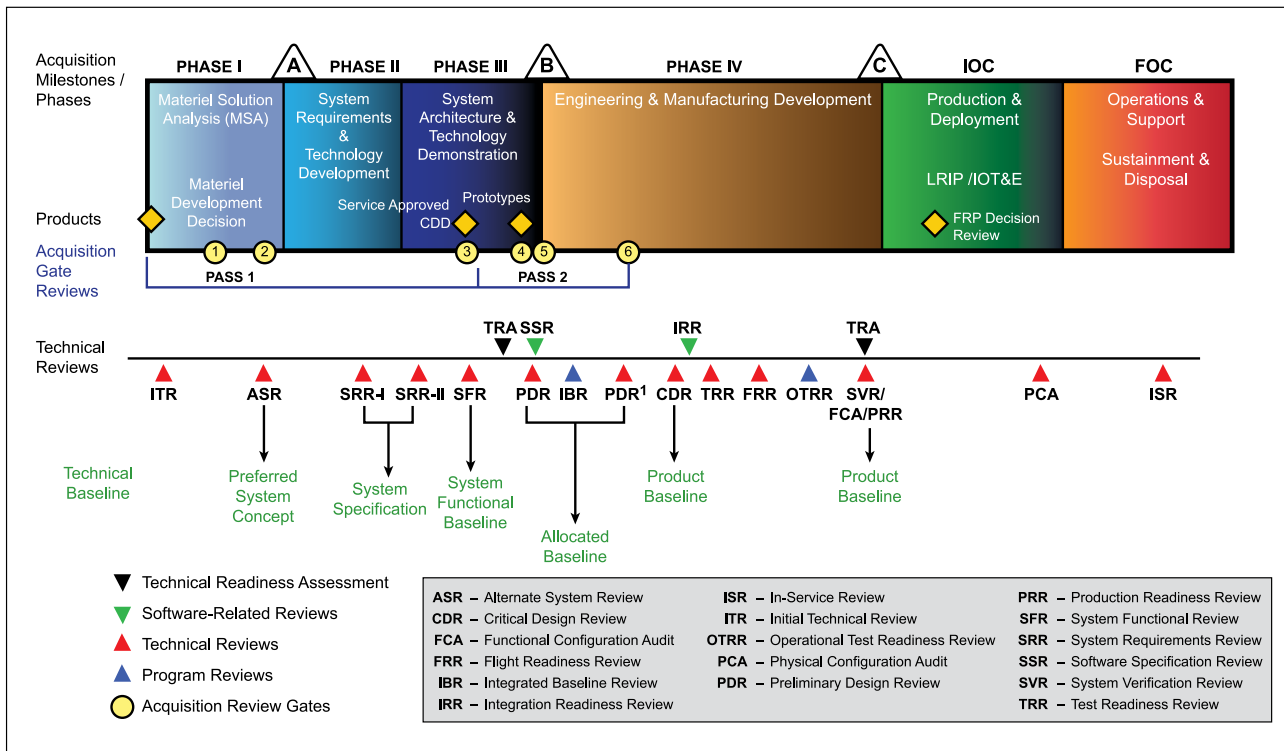

Figure 3. Systems Engineering Technical Review Timing

ability to develop, produce, and/or sustain directed-energy weapon systems. The ultimate goal of the directed-energy community is to deploy directed-energy weapons to the fleet. Accordingly, regardless of which phase or phases an organization in the community supports, its actions are impacted by the language in DoD Instruction 5000.02 and the WSARA of 2009. The more scientists and engineers in the organization are aware of governing policy documents like DoD Instruction 5000.02, the better their chances are of meeting DoD leadership's expectations in terms of cost, schedule, and technical effectiveness.

Actions have shown that DoD senior leadership has come to expect all weapon system programs to adhere to the current acquisition-related policy and guidance changes. As mentioned earlier, major weapon system programs have recently been canceled or restructured for not meeting DoD senior leadership expectations—something that rarely occurred previously. In today's environment, technology alone will not carry the argument for a program's survivability. Directed-energy weapons definitely carry the allure of a "Star Wars-like" capability, but these same weapon systems will need to show sustainable cost and schedule compliance if they are to come to fruition. Resources are too limited, and the warfighter has too many needs to allow unsustainable weapon system programs to continue. Therefore, everyone involved with the development, procurement, and/or sustainment of a directed-energy weapon system needs to have an adequate understanding of the acquisition underpinnings now governing DoD.

SUMMARY

The proverbial "winds of change" are blowing across the DoD acquisition landscape. The management of major weapon systems dependent upon cutting-edge technologies—such as those of directed energy—cannot afford to conduct business in a manner reminiscent of bygone days. Everyone involved with the development, production, or sustainment of a directed-energy weapon system needs to understand the "rules of engagement" laid down by the most recent DoD acquisition policy guidance. Highly skilled scientists and engineers typically already understand the need for a structured systems engineering approach to problem solving. Today, though, more than ever, cost and schedule must be factored in as potential tradespace to deliver the ultimate goal: a cost-effective, directed-energy weapon system delivered in a timely manner while meeting the warfighter's requirements. Scientists and engineers who adhere

to these recent acquisition changes will help their organizations achieve this goal, thereby ensuring that warfighters will be armed with the most technologically superior weapons possible.

REFERENCES

1. Congressional Research Service Report 7-5700, 10 July 2009, p. 3.
2. *Ibid.*, p. 8.
3. DoD Instruction 5000.02, 8 December 2008, p. 33.
4. *Defense Acquisition Guidebook*, 5 May 2010, paragraph 10.5.2.2.
5. *Ibid.*, paragraph 4.2.3.1.
6. *Ibid.*, paragraph 4.2.3.2.





THE BASICS OF ELECTRIC WEAPONS AND PULSED-POWER TECHNOLOGIES

By Stuart Moran

WHAT ARE ELECTRIC WEAPONS?

Most conventional weapons rely on chemical energy (explosives) as their destruction mechanism, either to explode on target, like bombs, or to create kinetic energy, like a bullet. Electric weapons are different. Electric weapons use stored electrical energy, rather than explosives, to attack or destroy the target. Electric weapons generally fall into two categories: directed-energy weapons (DEWs) and electromagnetic (EM) launchers. DEWs send energy, instead of matter, toward a target, and can be separated into three types: laser weapons, particle-beam weapons, and high-power microwave (HPM) or radio-frequency (RF) weapons. EM launchers use electrical energy to throw a mass at a target, thus making them distinct from directed energy. There are also three types of EM launchers: rail guns, coil guns, and induction drivers. All involve the use of strong magnetic fields to push against projectiles. While electric guns are an electric weapon, they are not a DEW.

High electrical powers and large energies are needed for all these weapons. Technologies for storing and controlling electric power are needed and are commonly called pulsed-power technologies. Electric guns are often associated with DEWs due to their common reliance on pulsed-power technology. The types of electric weapons are shown in Figure 1.

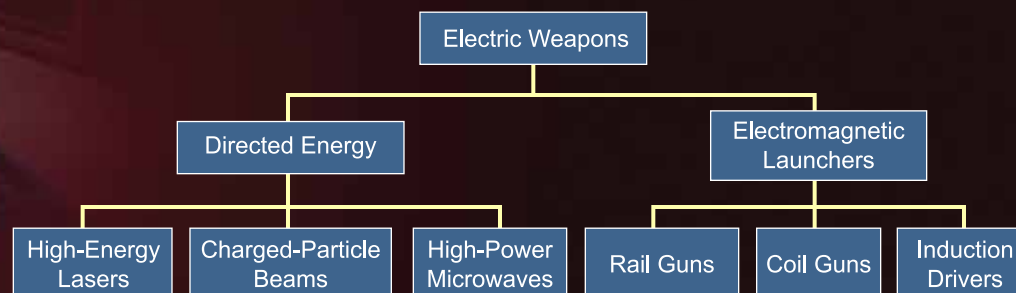

Figure 1. Types of Electric Weapons



There are a number of powerful advantages of electric weapons over conventional explosives:

- DEWs have a near-zero time of flight compared to conventional ordnance, allowing longer decision times and quicker reaction times.
- Electric weapons have a large “magazine” capacity, often limited only by the ability of the power source to recharge the system. The firing rate depends on how fast the system can be recharged, which in turn, depends on the available power source.
- The cost of engagement is greatly reduced. With increasingly sophisticated conventional weapons, the cost of practice rounds, such as a missile, can be millions. For an electric weapon, the cost per engagement is greatly reduced, making the attack of small targets (the asymmetric threat) less costly and training much more affordable.
- There is the potential for variable lethality, where the weapon effects can be controlled or attenuated to provide a warning or non-lethal effect. Otherwise, a full-power setting can be used to destroy the target.
- Electric weapons have the benefit of increased safety since less ordnance needs to be stored. Logistics costs less, and underway replenishment is easier since explosives are reduced or eliminated.
- Electric weapons can be used in conjunction with conventional weapons to heighten overall combat system effectiveness, such as knocking out electronics before engaging with a kinetic weapon.

Historically, the key Navy scenario for using directed-energy technologies has been close-in protection of naval vessels from antiship cruise missiles, particularly in a littoral environment. The ability of a DEW's speed-of-light engagement is particularly attractive under conditions of short warning times from supersonic stealthy missiles. However, increasingly difficult and problematic threats from nonmilitary aircraft and surface ships, countersurveillance platforms, fast patrol boats, unmanned aerial vehicles (UAVs), and terrorist inflatable boats or jet skis present different challenges. The threat has shifted from small numbers of expensive targets in open water to large numbers of small and cheap targets among neutral forces. The unique characteristics offered by DEWs, when compared to traditional weapon systems, allow them to be applied across a spectrum of threat roles, particularly in friendly or neutral-rich regions where precision pointing or less-than-lethal

capability is paramount. The potential for HPM to counter electronics at levels below human effects makes them ideal nonlethal weapons. Electromagnetically launched projectiles allow longer range, shorter flight times, reduced reliance on air strikes and missiles, and safer storage and replenishment. With military budgets being squeezed, the low cost of directed-energy engagements, which often require just a few gallons of fuel, cannot be overemphasized. Instead of million-dollar missile shots, electric weapons allow new tactics, warning shots, and continual fire against large and small targets. They also allow inexpensive practice and training for improved readiness.

PULSED POWER FOR ELECTRIC WEAPONS

A useful rule of thumb is that a stick of TNT contains about a megajoule (MJ) of chemical energy, and this amount is often needed to destroy a military target. To destroy a target with an electric weapon, the electrical energy must also be deposited quickly. Surprisingly, a candy bar also has a megajoule of chemical energy, but it is released very slowly when we eat it. Many electric weapons require peak powers of more than a gigawatt (GW) or energies more than a megajoule. The time scales for delivery range from milliseconds to nanoseconds. As an example, delivering 1 MJ of energy in 10 μ s requires 100 GW of power, which is more than a commercial power plant can produce. It is not practical to build continuous power supplies to directly drive most electric weapons. Consequently, pulsed-power technologies are needed to store energy at low power rates and release it quickly for weapon use. A pulsed-power system takes electrical power from a prime source (like a motor), stores it, and transforms the power to meet specific user requirements. The importance of a pulsed-power system is often underappreciated. For most electric weapon systems, the system size, weight, volume, and reliability are dominated by the pulsed-power chain. Pulsed-power components must be improved along with the weapon technology to make electric weapons systems practical. A block diagram of a pulsed-power system is shown in Figure 2.

Electrical energy can be stored in many ways, such as a battery (actually a chemical storage). A car battery has about a megajoule of energy, but it takes many seconds to drain it. A much faster method of storing electrical energy is in a capacitor, which can be discharged in milliseconds or faster. Inductive methods store the energy in the magnetic fields of a coil. This has the potential of achieving higher energy density than capacitors, but

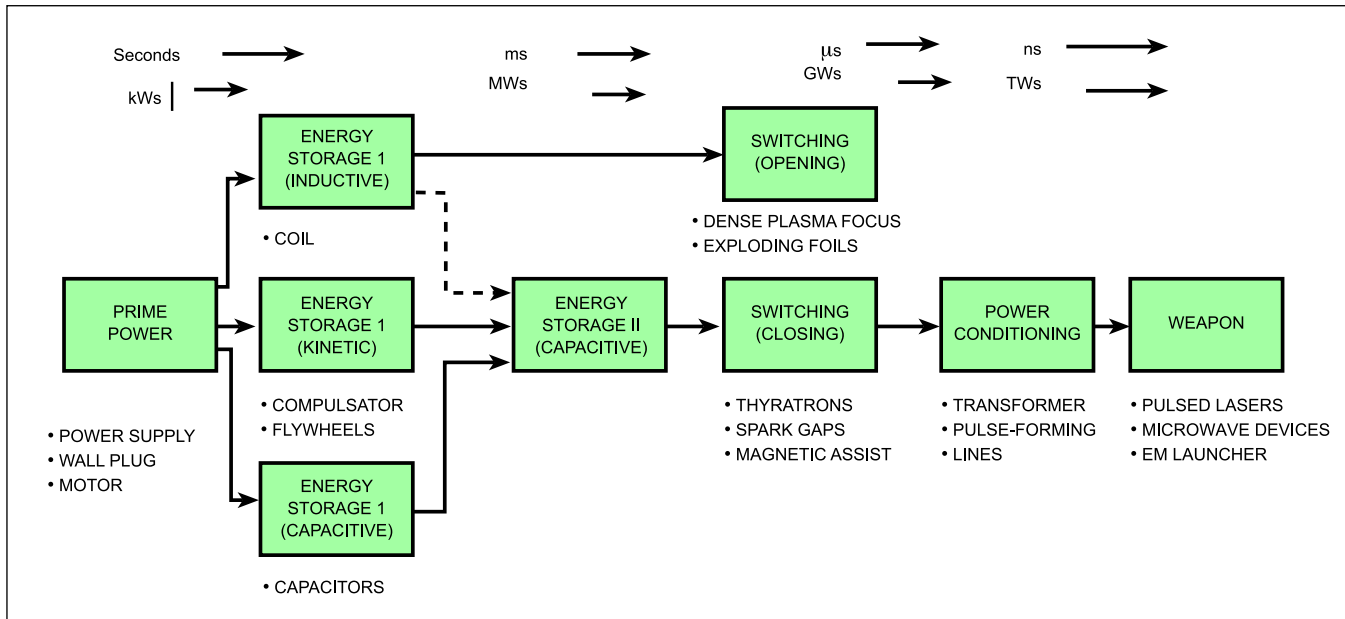
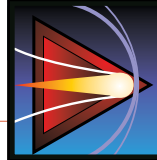

Figure 2. Block Diagram of a Pulsed-Power System

when the supporting systems are considered, the technology becomes less attractive. Energy storage for electric weapons can also be done with chemical explosive energy, where an explosive force is converted into electrical energy using techniques such as flux compression. Energy can be stored in the inertia of rotating machines and flywheels, but the energy can be released only as fast as the flywheel or motor can be stopped, usually in seconds. In many cases, several stages of energy store are used where each stage is faster than the last. Once the energy is stored, it must be released quickly using a high-power switch. There are many types of switches. Perhaps the most common type for electric-weapon applications has been the spark gap. Many types of controlled spark gaps exist, including pin-triggered, laser-triggered, field distortion, and simple overvolted. To achieve high repetition rates, flowing oil or gas can be used to flush the hot spark products, or sealed gaps using special fast-recovery gases, such as hydrogen, can be employed. Other switches, such as vacuum tubes and solid-state switches, can be used if they can handle the voltages and currents needed. Solid-state technologies, such as thyristors, have become very capable in recent years. Once the energy is switched out, there is usually some additional power conditioning, where transformers or pulse-forming networks are used to provide the desired pulse shape, voltage, and current required for the weapon. For rapid firing rates or continuous use, high average input powers are needed.

ALL-ELECTRIC SHIP

One of the major impediments to the development of electric weapons systems for Navy ships has been a lack of electrical prime power. Current surface combatant designs employ up to 90 percent of engine power mechanically dedicated solely to propulsion. These designs are unable to provide the tens to hundreds of megawatts (MW) of electrical power capacity required for many electric weapons. The solution is an electric-drive ship that uses all the engine power to generate electricity, enabling it to allocate power to weapons or propulsion as needed. In recent years, the Navy has been investigating cost-effective power-system options to meet future platform requirements.

HIGH-POWER MICROWAVE (HPM) AND RF WEAPONS

Microwave weapons are generally considered to use frequencies above a gigahertz, whereas lower frequencies are generally called RF weapons. These weapons are more powerful than electronic warfare systems and are designed to create extended disruption or permanent damage. An HPM weapon is considered to have a peak power of more than 100 MW, or energies above 1 J. The energy can enter a target through intended RF paths, such as target antennas (front door), or unintended paths, such as housing joints, cavities, and circuit wires (back door). Pulses ranging from a few nanoseconds to microseconds in duration can be sufficient to reset computers, cause loss of stored data, or

cause microprocessors to switch operating modes. Nonlinear circuits and components can rectify signals and absorb energy outside of their normal operating parameters. Figure 3 illustrates some of the vulnerability areas on a missile body.

RF or HPM devices can be divided into narrowband or wideband systems, dependent upon the employed pulse length. Narrowband systems are similar to high-power radar pulses and produce RF radiation with a very narrow bandwidth (frequency coverage). The damage concept is to create enough energy in a target to overheat or overload electronic components. Wideband systems generally produce very short pulses (nanoseconds) and typically operate in lower frequency ranges. Wideband systems produce much lower average powers and rely on high-peak electric fields to produce reset or arcing of digital components. Creating short pulses—often only a few RF cycles long—generates a very broad frequency output to take advantage of a target’s weak point. But, it also means that the energy is spread over many frequencies, so there may be very little energy at a specific vulnerable frequency. Vulnerability data is critical to estimate the effectiveness of HPM weapons. Ultimately, air breakdown will limit the amount of energy out of an antenna to around 1 MW/cm^2 .

HPM devices can produce effects that range from denying the use of electronic-based equipment to disrupting, damaging, or destroying such equipment. HPM weapon advantages include all-weather capability, low precision pointing requirements, and effects persistence after the radiated EM energy “beam” has been turned off. One major advantage of HPM is that electronics are generally more vulnerable to high fields and high energies than humans. This provides the ability to attack electronics without harming people, which makes HPM an ideal choice for nonlethal applications.

Two major challenges of implementing HPM technologies into an operational weapon systems platform are:

1. Fratricide, or self-destruction, can be a problem because of the large areas affected by the

sidelobes and near field of any meaningful HPM weapon system. Therefore, when attacking a target of interest with an HPM weapon, there is a greater risk of disruption to systems that were not intended to be targeted but fell within the sphere of influence. Host platforms, therefore, may need to undergo interference hardening.

2. With regard to battle damage assessment, kinetic weapons have the advantage of typically leaving visual evidence. HPM weapon systems do not leave large holes in a target but create more subtle influences as a result of attacking critical electronic components. Consequently, it can be more difficult to ascertain whether a target’s capabilities have been sufficiently degraded or destroyed—and for how long—in determining whether a mission was successful.

For HPM system development, a fundamental challenge is the understanding of what it takes to affect the target. Coupling mechanisms, where EM energy enters and affects the target system, are extremely complex. The vulnerability of components is often vastly different if it is outside or inside a circuit board or enclosure. Effects depend upon the interactions with other components, connectors, and nearby conductors. The effects on a component can vary many orders of magnitude depending on frequency, orientation, cracks and seams, protective circuits, pulse energy, and duration. Research regarding effects on missiles has shown large variations not only between designs, but also between different serial numbers due to assembly methods, cable routing, and component variations. With the increasing use of commercial equipment by the military, such as computers and radios, effects are difficult to predict due to constant design and component changes. In general, electronics are getting smaller and operating at lower voltages, making them more sensitive to high fields. But smaller components often have lower pickup areas, and the proliferation of interfering signals has increased the amount of shielding on modern electronics. When

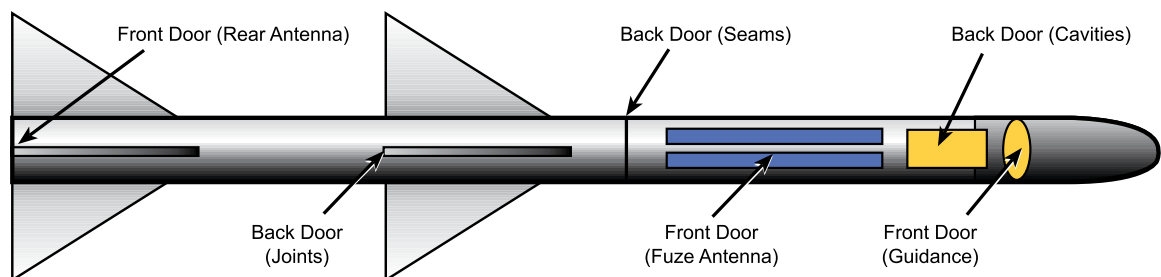
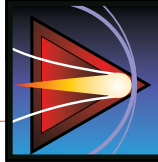

Figure 3. HPM Coupling Paths on Missile Body



target systems are located inside structures or buildings, it becomes even more difficult to predict. Efforts to predict reflections and interference inside complex structures become extremely complicated. Accordingly, generic electronics kill using universal waveforms is not likely. There continues to be a lot of hype about what RF weapons can do, but the idea that a backpack device can wipe out all electronics in a city is no more realistic than a hand-held laser cutting through a bank vault door.

HIGH-ENERGY LASERS (HELs)

A laser generally produces a beam of coherent light at a specific wavelength dependent on the atomic structure of the lasing substance. Only certain substances have the atomic properties appropriate for producing laser light, and these are often limited in power. Lasers are characterized by the substance being lased (gas, liquid, or solid) and the “pumping” process (light energy, electricity, or chemical reaction). A resonant optical cavity provides the means for aligning the energy in the beam and extracting that energy. A military laser system also includes beam processing or beam-path conditioning, beam pointing and control and—for long-range applications—adaptive optics to compensate for the atmosphere.

Until recently, HELs have been driven by chemical energy, so very little electrical power or pulsed power was needed. Chemical lasers use the reactions of gases or liquids to create the excited energy states necessary for laser emission. Large chemical lasers and beam directors have been developed by the Navy in recent decades and have successfully ruptured fuel tanks and downed supersonic missiles. However, these lasers required high-velocity, chemical-reaction chambers and emitted hazardous gaseous by-products. They often operated at wavelengths where the atmosphere absorbed much of the energy. Absorption creates thermal blooming, whereby absorbed energy in the air creates a negative lens that defocuses the beam. Increasing the power of the laser increases the energy absorbed and worsens the problem. The Army and Air Force are developing chemical lasers for airborne applications, where atmospheric absorption is less of a problem. Recent Navy interest in HELs has concentrated on lasers that are electrically powered, rather than chemically powered, and that operate at shorter wavelengths to allow smaller optics and more efficient propagation near the water.

Small semiconductor (or diode) lasers use current flow through an electrical junction to excite electrons and create laser light. These lasers are very limited in power, so research has focused on

using large numbers of lasers assembled into a coherent array. Semiconductor lasers also create efficient light to excite or “pump” other types of lasers. Solid-state lasers (SSLs) use crystalline materials mixed (doped) with elements needed for proper lasing. SSLs show strong promise for compact, medium-power HEL weapon systems. Scaling these systems up to megawatt levels creates extreme heat in the crystal material, making it very difficult to prevent internal damage. Forced cooling and the heat capacity of large masses are under study.

Fiber lasers—which use semiconductor diode lasers to pump a flexible, doped crystalline fiber (similar to a fiber-optic line)—have demonstrated high efficiency and relatively high power. The technology is being used in the welding and cutting industries. Methods of pumping large numbers of fiber-optic lasers and combining them are being investigated. An example is shown in Figure 4.

The free-electron laser (FEL) operates differently from a conventional laser. An FEL uses a high-voltage electron accelerator to push electrons through a magnetic “wiggler” to create light radiation across a tunable band of frequencies. The FEL is extremely complex and large, but scaling to very high powers may be possible. Perhaps the biggest promise of the FEL is the ability to design the laser at an ideal atmospheric propagation wavelength. Significant technical hurdles remain in reaching the status of a deployable FEL, in scaling the beam to megawatt powers and in providing the necessary engineering to turn a laboratory device into a weapon system of reasonable size. For Navy application, FELs will require improvements in areas of radiation shielding, high vacuum, high-current photoinjectors, and probably cryogenic cooling—all of which must be integrated into a ship’s basic design.

Fiber lasers and SSLs are the leading-candidate Navy lasers for medium power, as FELs are for high power. All are electrically driven and can meet the requirement for shorter wavelength, capable of transmitting at the “maritime window” of approximately 1 μ .

HEL weapons’ advantages include a highly directional and narrowly focused beam, providing:

- Minimal collateral damage
- Speed-of-light delivery
- Rapid retargeting
- Low cost of engagement

Disadvantages center on:

- Limited range due to atmospheric attenuation
- Weather limitations
- Low efficiency (often less than 10 percent)
- Need for eye protection
- Relatively large size and weight requirements



Figure 4. Drawing of Laser Weapon System (LaWS)

Long dwell times (seconds) will be needed for most targets. As with RF systems, there is a potential nonlethal or variable lethality capability since the energy can be easily defocused. A critical challenge is the understanding of a laser beam's propagation through a maritime boundary layer environment, where the sea and air interface creates turbulence and moisture gradients. Measuring the atmosphere and compensating for variations in real time may require adaptive optics or “rubber mirrors” that can be constantly adjusted to compensate for changes. Focusing a small spot at long range will require high beam quality and large optics, probably meter-size mirrors that are very highly reflective and very clean.

HELs in the future are expected to be able to focus energy to a spot size of much less than a meter at ranges of kilometers. This will necessitate very accurate target tracking systems, and precise stabilization and beam-pointing systems, both of which are difficult but should be feasible in the near term. Real-time atmospheric measuring systems will be needed for compensation techniques. Methods to protect the sensitive optical system from salt spray and corrosion will also be needed.

From a lethality perspective, three considerations need to be better understood before a HEL can be deemed a true weapon system:

1. Achievable spot size of beam on target at range
2. Amount of coupling into the target material
3. Subsequent effects of the damage inflicted

For the more severe threats, such as high-speed, antiship cruise missiles, HELs face the difficult task of engaging maneuverable, stealthy, inbound missiles. As such, a better quantitative understanding of the interactions among a laser beam's energy deposition, target material, and flight dynamics is needed.

PARTICLE BEAMS

A particle-beam weapon is a directed flow of atomic or subatomic particles. These particles can be neutral or electrically charged. Neutral beams need to be used outside the atmosphere (in space), where charged particles would repel and fly apart. Charged-particle beams (CPBs) are easier to make and are used within the atmosphere, where air molecules can constrain the

beam. A CPB weapon transmits matter—not just EM waves—like lasers and microwave weapons. The particles are near the speed of light and deposit their kinetic energy deeply into any target material. They have the potential to be highly destructive weapons and are very difficult to shield against.

Charged particles are produced by applying a strong electric field near a material that emits electrons. These electrons then pass through accelerating stages with high voltage gradients (often megavolts), which increase the electron's velocity. As the electrons pass each stage, the velocity increases until they approach the speed of light (become relativistic), at which point they have substantial energy to penetrate a target. The accelerating systems can be linear, but a recirculating design is more compact and can reuse stages. These systems are basically high-current versions of scientific particle accelerators.

Once the electron beam is produced, it must propagate to the target. High-velocity electrons will not go far before they collide with air molecules and lose energy. The fact that air molecules struck by the beam are heated and moved out of the way for a short period of time creates a rarified “hole” in the atmosphere through which a second pulse can travel farther. In this manner, a fast series of pulses can “hole-bore” to the target, each pulse going farther than the last. The final pulse must have enough energy to damage the target. The deceleration of electrons in the atmosphere causes

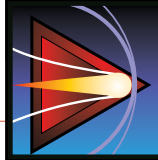

Bremsstrahlung radiation in the forward direction toward the target, creating gamma rays that, in turn, create X-rays and RF radiation.⁴ These effects can cause electronic upset and “soft-kill” mechanisms even if the beam slightly misses the target.

The beam of electrons is typically a few centimeters in diameter. When a beam strikes a target, the energy is deposited deep in the material (the collision cross section is small because of the relativistic speeds) in microseconds (much faster than a laser), creating thermal shock that is very difficult to shield against. For an explosive target, there is also the possibility of causing a deflagration or low-order burn, disrupting the normal warhead mechanism.

Scientists studying CPB weapons made significant technical advancements in the 1980s, but the weapons are still far from being practical. A CPB weapon is technically very challenging and expensive to build. Studies project that the volume requirements necessary for a CPB system could be on the order of a 5-inch gun system. Advantages of a CPB weapon include rapid penetration, a deep magazine, all-weather capability, and

soft-kill mechanisms for a near miss. Problems include complexity, size, limited range, and the need to demonstrate compact accelerators and propagation mechanisms.

ELECTROMAGNETIC (EM) LAUNCHERS

A number of technology concepts to launch projectiles exist using electrical energy. These systems rely on large currents in conductors, creating strong magnetic fields that drive a projectile. The velocity of a normal powder gun projectile is limited by the expansion speed of the explosive powder, and present military guns are reaching that limit. With an electric gun, the fields can push projectiles much faster, providing longer ranges and increased kinetic energies. The simplest version is an EM rail gun, shown in Figure 5.

In any conducting loop, the generated magnetic field tries to expand the loop. If everything is held in position, the only movable item is the conducting projectile, which moves down the rails in an attempt to expand the loop. Since megajoules of projectile energy are needed for EM rail guns, energy storage

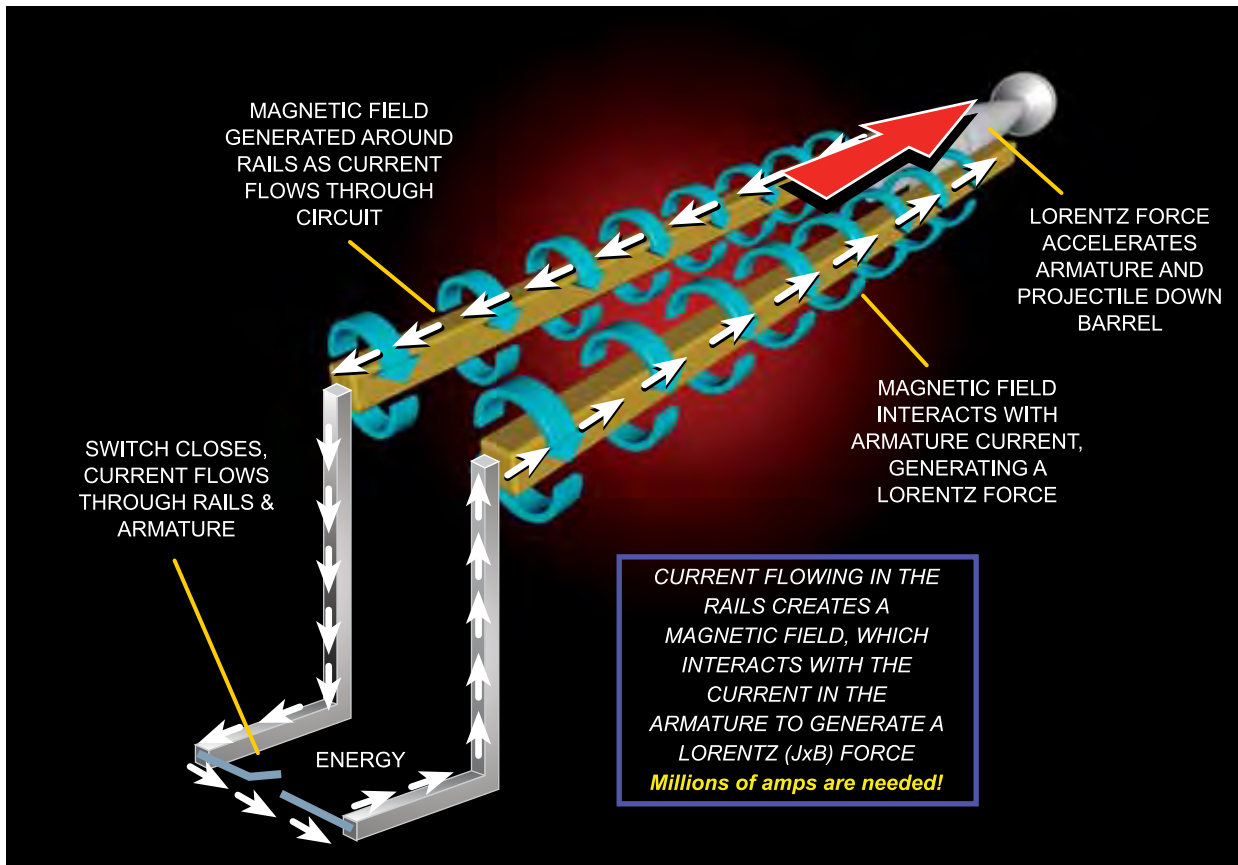

Figure 5. Electromagnetic (EM) Rail Gun Concept

mechanisms that can store about 100 MJ are needed, along with the ability to discharge the energy in milliseconds. To generate useful forces, millions of amps of current are needed—a major challenge and significant loss mechanism. Large capacitor banks with very high-current switches are required. Spark gap switches have historically been the only option, but new high-current solid-state switches are now becoming available. Capacitor energy densities, too, have improved an order of magnitude in the last few decades. Rotating machines have also been considered because they are smaller than equivalent capacitor banks, but extracting the energy quickly, without tearing the machine apart, has been problematic. The launch energy of various projectiles is shown in Figure 6.



Figure 6. Launch Energy of Various Projectiles

A rail gun is probably the most compact form of electric launcher. However, it requires direct electrical contact between the projectile and barrel rails, creating the potential for arcing, melting, and erosion. Coil guns use a series of sequentially fired coils around a “barrel” to push the projectile in stages. This does not require direct electrical contact, so it avoids rail erosion but requires a series of fast timed switches and more space. Linear induction motors are basically unrolled electric motors and have been used on electric trains and roller coasters, typically with magnetic levitating systems to avoid contact erosion. This concept is being developed by the Navy for launching aircraft. The energy to launch an aircraft is similar to a large-caliber projectile—more weight but less speed. The

slower speeds are more suitable for rotating machines since the launch times are seconds rather than microseconds.¹ Electrothermal guns and electrothermal-chemical (ETC) guns use a combination of electricity and chemicals. Electrical energy is used to initiate chemical reactions that can produce lightweight driving gases, like steam, or allow more energetic propellants that are difficult to ignite in a conventional fashion.

Some advantages of electrically driven projectiles include:

- Higher projectile velocity (over conventional explosives)
- Very long range (>100 miles) with lower cost than missiles
- Time-critical delivery (because of shorter time of flight)
- Safer projectile stowage (minimal explosives)
- Potentially adjustable velocity levels, for better accuracy and controllable damage

The potential of having nonexplosive rounds and magazines is very attractive for the Navy. For long-range, large-caliber EM projectiles, the kinetic energy from the projectile velocity is greater than the chemical explosive energy in a conventional round traveling much slower. Therefore, damage can be equivalent even without explosives. System size and lifetime are still behind conventional systems, but getting close.

OUTLOOK

Challenges remain for many electric weapon concepts. These weapon systems appear promising to meet the increasingly important asymmetric threats with low-cost precision rounds. They also can be employed across the energy spectrum for nonlethal targeting. Electric weapon systems will, in many cases, continue to supplement existing kinetic weapon systems in the near term. Despite technology challenges, directed-energy and electric weapons hold great promise in offering the future warfighter unique combat capabilities not currently available.

ENDNOTE

- a. Bremsstrahlung—a type of radiation emitted when high-energy electrons are decelerated. (German for *braking radiation*)

REFERENCE

1. Shope, S. et al., *Long-Range Naval Fire Support with a Coilgun*, Sandia Report 2001-3832, February 2002.



SOLID MODELING OF DIRECTED-ENERGY SYSTEMS

By Joseph F. Sharrow

Not long ago, around the mid-1980s, development of most new mechanical systems—such as automobiles, consumer products, and military devices—was performed manually on a drafting table or drawing board, much like the present-day version shown in Figure 1. These tables and boards performed a necessary function, but they offered little assistance other than for drawing lines. Engineers used them to prepare layouts, or two-dimensional sketches of what they were designing. They then would take these layouts to a draftsman, who would create drawings of each part in the device. The drawings would subsequently be sent to a manufacturing facility.

This layout and drawing preparation process typically would need to be repeated multiple times because mistakes would be made, or design issues would be discovered late in the process. Similarly, the manufacturing process would sometimes require multiple iterations as well because of the inherent limitations in designing three-dimensional (3-D) devices on two-dimensional boards. This less-than-ideal process made it difficult to design and manufacture even mundane products and frequently resulted in things that just didn't work. With the emergence of early computerization, numerical analyses of more complex systems began to be performed. These analyses were conducted to ensure that the systems worked in the real world. For example, engineers might conduct a structural analysis of the forces in a loaded dump-truck bed to make sure that the frame wouldn't bend and fail. Because of the difficulty in performing these analyses, they would often require a specially trained group of structural engineers, expensive software, and large mainframe computers, limiting their use to only the largest, most well-funded companies or organizations.

EMERGENCE OF COMPUTER-AIDED DESIGN (CAD) AND SOLID MODELING

With the availability of smaller scale computers and more economical software in the mid-to-late 1980s, CAD was born, initiating a period of rapid improvement in the design process. This was driven, in part, by the introduction of software packages such as AutoCAD. Initially, these software packages only attempted to automate drawing lines by making wireframe (stick-figure) versions on the computer of what previously had been made by hand on the drafting board. This reduced the difficulty in making changes in the development process, but it still limited the engineer's pallet to a two-dimensional space. What was really needed was a 3-D method of design. Solid modeling



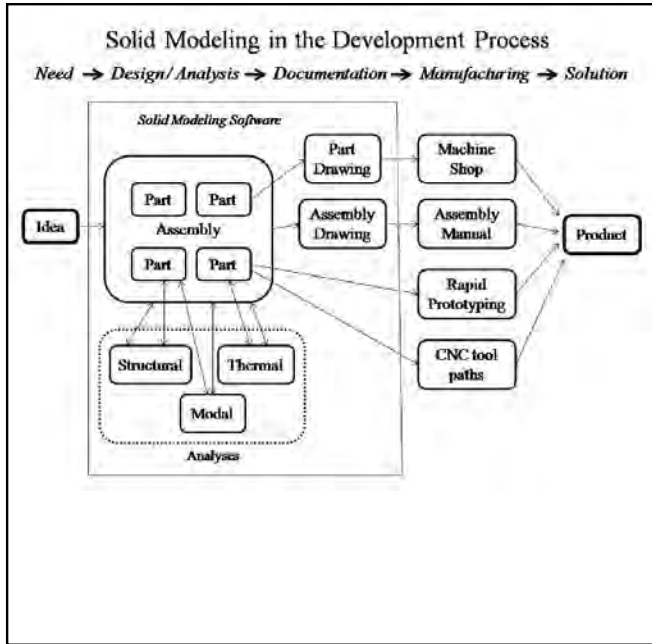

Figure 1. Drawing Board

addressed this need beginning in the late 1980s to early 1990s.

Solid modeling is analogous to taking blocks of clay and cutting and forming them into the shape of a solid part on a computer. These 3-D parts are then put together in an assembly, more accurately representing real-world devices. Though originally used only in a limited way for specialized applications in the aircraft and automobile industries, it wasn't until the 1990s that solid modeling experienced widespread availability and mainstream acceptance due to software packages such as Pro/ENGINEER. Figure 2 summarizes how Pro/ENGINEER and other similar packages fit into the development of new products. The general flow of the process moves from left to right.

Initially, nearly all 3-D solid modeling packages required significant computing and graphics display power, necessitating the use of large graphics workstations running the UNIX operating system. Rapid advances in computing and graphics power have since enabled nearly all packages to run efficiently on personal computers (PCs) and laptops, bringing solid modeling and analysis capability into the mainstream.

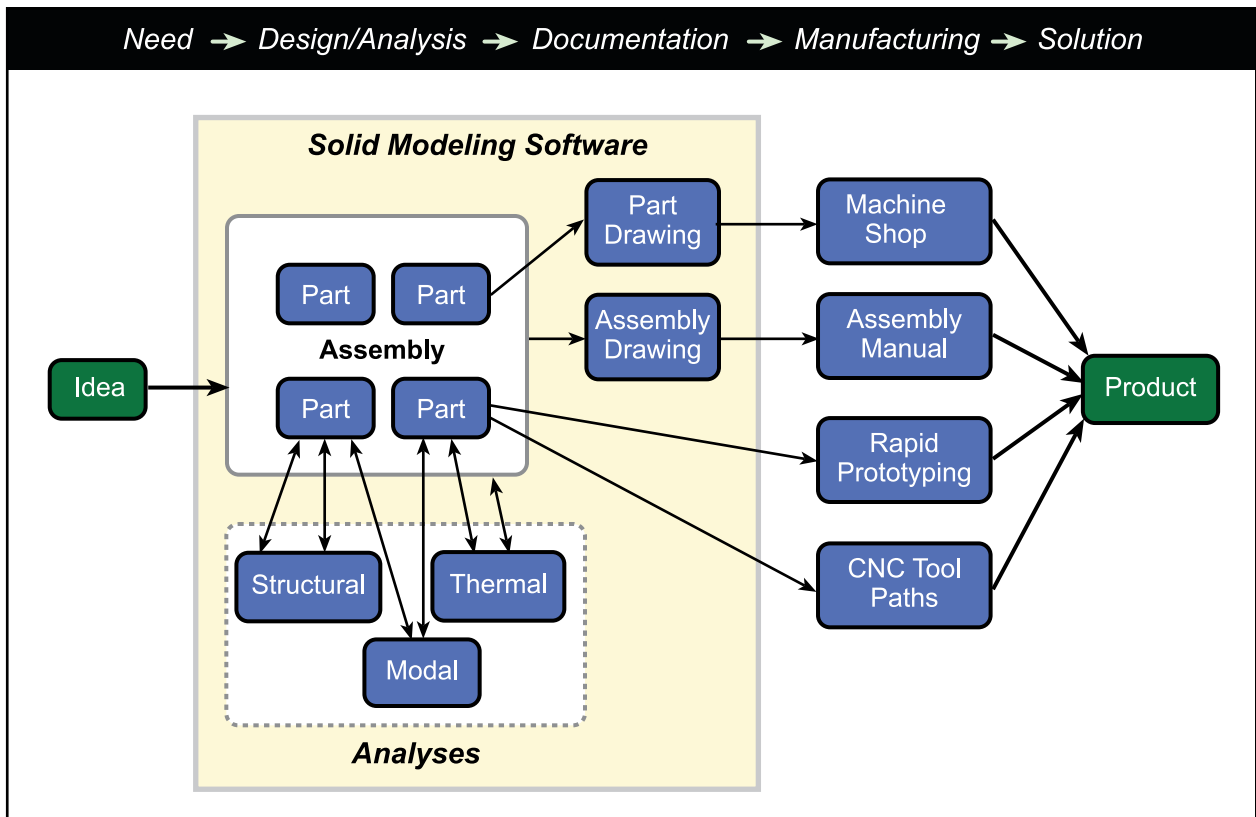
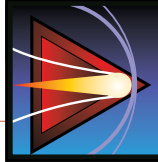

Figure 2. Solid Modeling in the Development Process



SOLID MODELING OF DIRECTED-ENERGY SYSTEMS

Engineers working in the Directed Energy Division at the Naval Surface Warfare Center, Dahlgren Division (NSWCDD), use solid modeling to develop hardware for nearly all of its programs. Both Pro/ENGINEER and SolidWorks are used extensively to develop new products in virtual 3-D space. Additionally, the structural simulation package within Pro/ENGINEER is used to determine stresses and natural frequencies of parts and assemblies. Consequently, these packages have enabled a single mechanical engineer in the Directed Energy Division and a draftsman in the Engagement Systems Department at Dahlgren to perform the design and analysis work that would have required an entire group of engineers and draftsmen just a few years ago. Today, collaboration among many organizations using similar packages has become commonplace. Insofar as solid modeling has become an indispensable tool for development and collaboration, its successful implementation requires proper training and experience before engineers can use it effectively, just as medical surgeons require training in the use of advanced robotic surgical devices before they can be used effectively. Thus, while these high-tech modeling systems not only have reduced the number of personnel needed for design and development, they have enabled the Navy to get significantly more bang for its buck while supporting warfighting needs. An example of how solid modeling is currently being used is discussed below.

NAVY LASER WEAPON SYSTEM (LAWS) BEAM DIRECTOR

The Directed Energy Warfare Office (DEWO) and Directed Energy Division at Dahlgren are currently developing the Navy LaWS for the Naval Sea Systems Command's Directed Energy and Electric Weapon Systems (DE&EWS) Program Office (PMS 405). The program's goal is to take advantage of currently available industrial laser technology and incorporate it into a future naval weapon system. As part of the development process, major subsystems have been integrated with a Kineto Tracking Mount (KTM) into a LaWS beam director. The KTM/beam director was modeled and analyzed using Pro/ENGINEER. Ultimately, the resulting LaWS will be installed on Navy ships on the Close-In Weapon System (CIWS) gun mount. During field testing in June 2009 at the Naval Air Warfare Center, China Lake, California, the prototype KTM/beam director successfully destroyed five unmanned aerial vehicles (UAVs). The actual beam director used in the

China Lake testing is shown in Figure 3; the Pro/ENGINEER assembly model used for development is shown in Figure 4.

The LaWS effort took advantage of many aspects of solid modeling including collaboration, structural and modal analysis, and manufacturing drawing creation. The project required development of new, unique hardware, as well as the integration of electronic models from commercial vendors. The KTM model was provided by L-3 Brashear and was originally designed using Pro/ENGINEER. The beam-directing telescope model was provided by RC Optical Systems, Incorporated, and was originally made in SolidWorks. These models were combined with many new optical and structural components developed by the Directed Energy Division into a single, comprehensive assembly model. This model was instrumental in understanding the interaction of the many components, and its use increased accuracy and precision that would have been impossible with old-fashioned two-dimensional development processes. Figure 5 shows a cross section through the main portion of the beam director, revealing the complexity of the many parts and subassemblies required for such a device. In addition to modeling the mechanical components, the actual laser beams were also included to better understand their path through the various mirrors and optical devices in the beam director, and to better highlight any interference they might have with structural components within the KTM or telescope.

Numerous analyses were performed to make sure that everything worked the way it was intended. One major analysis addressed the telescope mount. To ensure that the beams were stable at range, the mount had to be extremely stiff. The best way to ensure this was to perform a structural analysis using the structural simulation package within Pro/ENGINEER. Figure 6 shows the results of that analysis: a displacement plot in which different colors represent how much the telescope will move when the KTM rotates at its maximum speed. The large cylindrical object simulates the mass of the telescope. The minimum amount of displacement is indicated by blue, and the maximum is shown in red. This analysis verified that the movement of the telescope, relative to the optical components within the optics breadboard, was acceptable and should perform well at the range specified by the program office.

After modeling and analysis were completed, manufacturing drawings of custom parts were created by the Engagement Systems Department to be



Figure 3. LaWS Beam Director



Figure 4. LaWS Beam Director Assembly Model

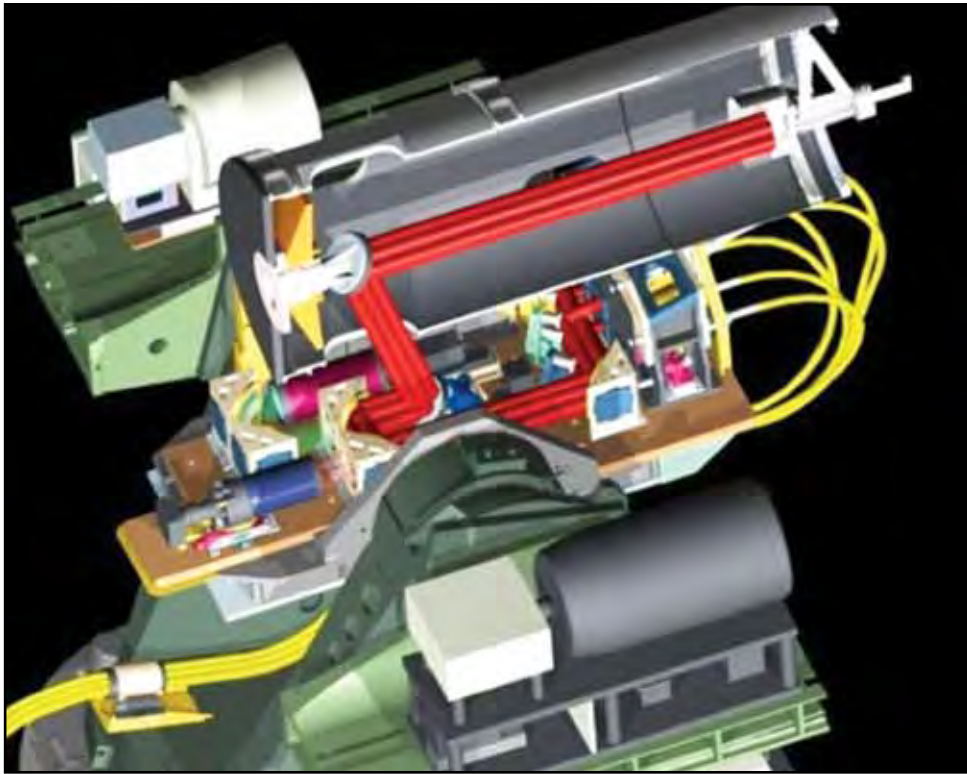
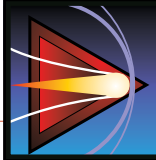

Figure 5. LaWS Beam Director Cutaway

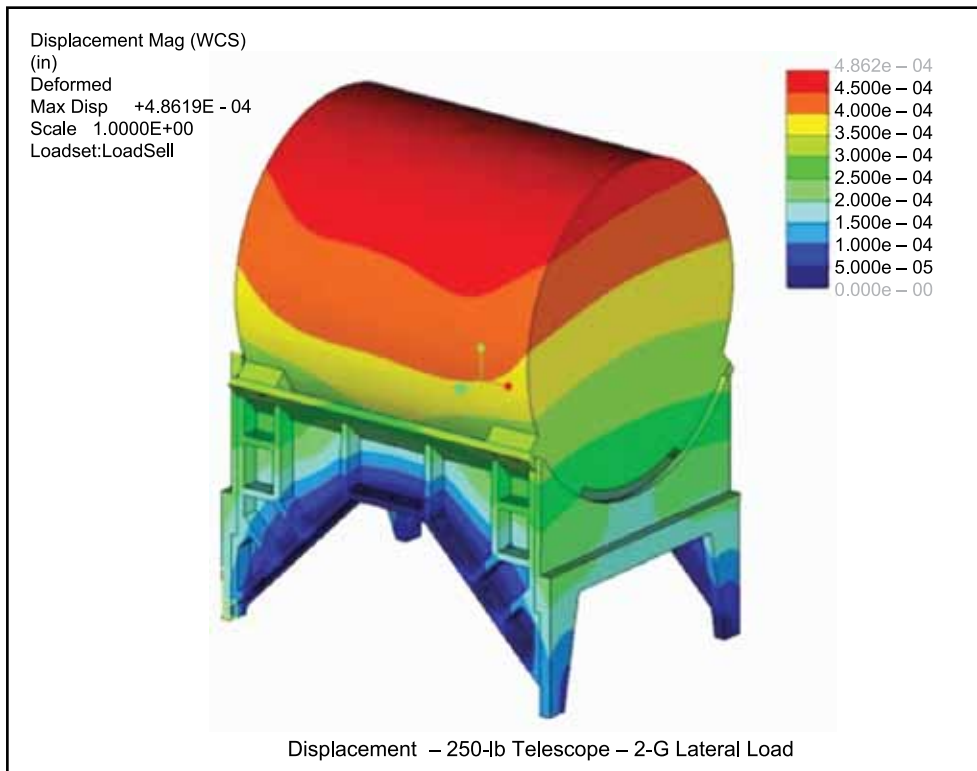

Figure 6. Displacement Plot

sent to manufacturing facilities, such as machine shops. One example is shown in Figure 7, which shows the first sheet of the multisheet drawing needed to manufacture the large plates that support the telescope from the center platform of the KTM. One of these plates is also shown in the displacement plot in Figure 6.

Even though it would be possible for one person to do all of the modeling, analyses, and drawings for a particular program, a more efficient process takes advantage of using the best skills available by collaborating with other experts. Collaboration enables assembly, part, and drawing files to be sent electronically, eliminating the need for collocating personnel. Drawings for the LaWS program, for instance, were made using noncollocated personnel

across base at NSWCCD. They could just as easily have been made using personnel from across the country.

The LaWS program exemplifies how the Directed Energy Division uses solid modeling to enhance the quality and effectiveness of Navy directed-energy capabilities. As a result, warfighters will be better armed with more effective weapons and capabilities for future naval conflicts.

ACKNOWLEDGMENT

The author would like to acknowledge the valuable contributions of the Engagement Systems Department's drafting group in support of numerous DEWO and Directed Energy Division programs.

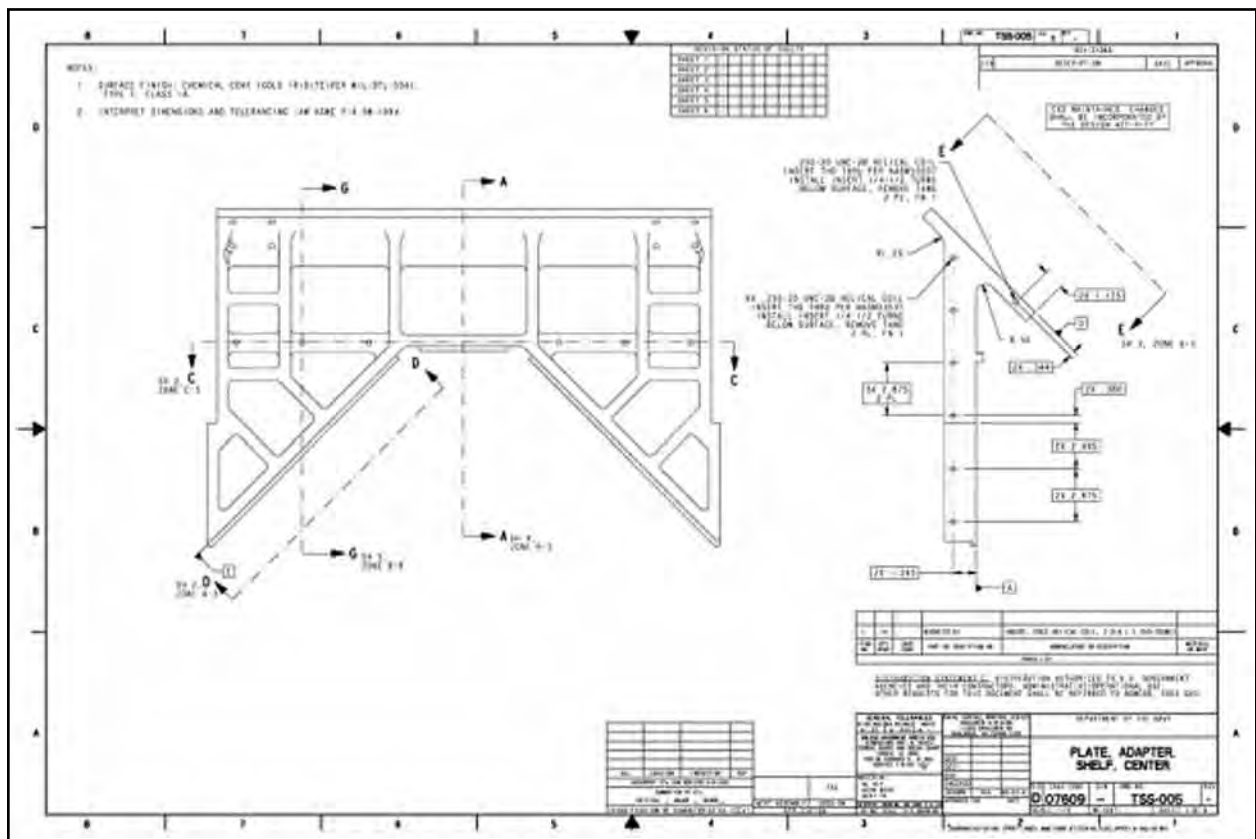
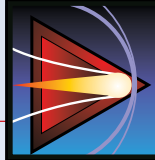

Figure 7. Manufacturing Drawing



A FUNDAMENTAL KEY TO NEXT-GENERATION DIRECTED-ENERGY SYSTEMS

By Directed Energy Division, Electromagnetic and Sensor Systems Department

Imagine an explosive ordnance disposal (EOD) unit on a routine scouting patrol deep in the notorious “Triangle of Death” south of Baghdad, where Marines, Sailors, and Soldiers frequently find themselves exposed to improvised explosive devices (IEDs). Fortunately, this newly outfitted unit is equipped with the latest unmanned, mobile, remote-controlled, radio frequency (RF) transmitter used as a directed-energy weapon (DEW). The integrated system provides comprehensive IED prediction, detection, prevention, and neutralization capabilities. Lightweight, pocket-sized transmitters carried by each warfighter constantly communicate sensor intelligence, key vital signs, critical conditions, and location telemetry to a geostationary satellite (GEOSAT). It intercepts, collects, and retransmits intelligence and situational awareness data simultaneously to any command post in the world and to each member of the unit on patrol. Highly efficient, miniature, switch-mode, RF amplifiers with high-power density (small size and weight with high-power output) enable these visions of future capabilities as their systems’ transmitter backbone.

To civilians, the miniaturization of modern wireless (electromagnetic) devices is considered a mere convenience or luxury, i.e., Blackberries, mobile phones, and high-speed wireless network connections. To the next-generation warfighter, miniaturized, wireless, directed-energy (DE) systems open the door to the realization of a whole new set of effective and efficient wireless modalities. And while the capabilities mentioned in the above scenario are not yet available to warfighters, researchers believe they have uncovered the key to next-generation DE systems leading to the miniaturization of DE devices.

NEXT-GENERATION DE SYSTEM REQUIREMENTS

At the Naval Surface Warfare Center, Dahlgren Division (NSWCDD), key system requirements for effective next-generation DE systems are being researched and developed for applications to counter IEDs, to detect explosively formed penetrators (EFPs), to neutralize explosives, and to predict threat locations. Next-generation DE systems must yield a high probability of mission success and be inherently safe to operate. By design, they must minimize or eliminate the risk of hostile attack or collateral damage especially during screening missions. Considering the DEW example above, practical





080102-N-1132M-006 SHEIK SA'ID, Iraq (2 January 2008) U.S. Army Soldiers attached to 3rd Squadron, 2nd Cavalry Regiment patrol and search for weapons or Improvised Explosive Devices (IEDs) during a clearing mission. (U.S. Navy photo by Mass Communication Specialist 1st Class Sean Mulligan/Released)

next-generation DE systems must be physically characterized by:

- Low mass (weight)
- Small size (volume)
- High-power output with respect to size or high-power density
- High efficiency for extended mission use
- Minimized prime power and cooling support
- Portability
- Mobility
- Configurability

They must also ensure a high probability of mission effectiveness. The DEW must be easily transportable and agile, adapting to the immediate, local military mission requirements in various warfighting environments. Additionally, DE systems must be mechanically robust and able to withstand the shock and vibration of combat missions in rough and rugged environments. The key requirement—efficiency—fundamentally facilitates all required characteristics, including mass and size.

MOVING BEYOND REQUIREMENTS

Scientists at NSWCDD, sponsored by the Office of Naval Research (ONR), are researching and developing key system requirements for effective next-generation DE systems to counter IEDs, to

detect EFPs, to neutralize explosives, and to predict threat locations.

Researchers at NSWCDD are leading the way toward realizing small, lightweight, RF transmitters using high-power, solid-state, switch-mode amplifiers, theoretically 100 percent efficient. These practical switch-mode amplifier realizations are at least 1/100 the volume and weight of any commercially available linear solid-state amplifier of comparable power output. The challenges included assessing what type of active amplifier device and operation would provide the greatest power density (power output per unit volume and mass) with its necessary auxiliary systems, such as prime power generation and cooling of waste heat. Such a device also needed to provide sufficient output power based on required standoff range and IED system-coupling efficiency while also maintaining a manageably-sized, easily transportable system. Researchers initially considered tube-based systems, but large, heavy, direct-current (DC) power supplies are required, and typically 40 percent of the input power is dissipated in heat, which negates any possibility of miniaturization.

Upon a practical review of amplifier-class operations and suitable active amplifier devices, however, research pointed to contemporary switch-mode

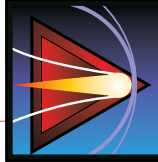

amplifier schemes (e.g., Class-E and Class-F) using solid-state technology—such as the high-electron mobility transistor (HEMT)—as satisfying the high-power density and abusive mechanical requirements for expected worst-case transportation and operation in a rugged environment. To significantly impact reduction of size and weight, practical, high-efficiency thresholds were defined for next-generation DE systems at 90 percent and greater. The key technology enabler to realize amplifier high efficiency in high-power amplifiers up to 60 kW was found in exploiting contemporary switch-mode amplifier architecture with efficient power combining. Particularly, switch-mode schemes in Class-E and Class-F operation as solid-state, active-hybrid planar topology designs were found to be necessary and sufficient for DE applications. These analyses led to a novel, Class-E RF switch-mode amplifier design. A Class-E RF switch-mode amplifier can theoretically operate at 100-percent efficiency. For every input watt supplied, an RF output watt is produced. The conductors and dielectric substrate of the hybrid planar load network and the commercial off-the-shelf (COTS) transistor all exhibit some small degree of power loss, suggesting an estimated practically realized efficiency of 90 percent.

Moreover, the amplifier under research consisted of a novel microwave load network operating with high-power output at ultrahigh frequency (UHF). This research led to the state of the art in Class-E designs leading by hundreds of watts, several hundred megahertz in frequency, and roughly 10 percentage points in efficiency. A common, solid-state, high-power amplifier design technique sums the phase and amplitude of smaller amplifier units to the large values required for DE systems. A practical hardware limitation exists that limits the theoretically infinite number of fixed RF output power units to a finite number. Approximately 60-kW RF output power sets the boundary as the largest hardware realization. By applying spatial power combining in the propagating medium, phased-array antennas can be employed with constructive wave interference in air that would allow sufficient RF power densities on target, based on the number of elements in the array. This technique eliminates the traditional hardware necessary to power combine the smaller power-amplifier elements, realizing a much simplified DE system with enhanced power density in the transmitter, and reduced mass and volume.

The key to ultrahigh efficiency in a switch-mode amplifier, such as Class-E or Class-F, is found in zero-voltage switching (ZVS). Here, the load

network is not only designed to be resonant at and around a particular desired switching frequency, it must simultaneously act to force the voltage across the switch to be zero when current flows and when it switches off; hence, theory suggests that no power is dissipated because the product of current through, and voltage across, the switch is zero. It is this aspect of the design that makes the job of switch-mode amplifier realization difficult. Of course, in practice, a small voltage exists for a very short time during the switching action, resulting in a small amount of input power being dissipated in heat. This theoretical description also assumes that all components are ideal (i.e., no impedance to current flow exists in the switch when turned on). All realistic switches exhibit finite impedance when turned on, which does dissipate some wasted energy, but again, this is very small in modern HEMT devices using the ZVS technique.

Class-E switch-mode amplifier theory development began in the United States during the 1960s, with details published in 1975, although some earlier reports were published in Russia. Lumped element electrical components (RF choke inductors and metal film capacitors) were initially used in lower frequency (3 to 30 MHz) prototypes. As engineers attempted higher frequency designs in the very high frequency (VHF) range, solid-state transistor switch parasitic intrinsic and packaging elements found inside the transistor began to be used as some of the key components necessary for ZVS. These parasitic elements included stray capacitance caused by differences of potential between parts inside the transistor and inductance caused by bond wire length that is used to connect the transistor to accessible terminals in its packaging. At microwave frequencies, these parasitic elements become sensitive, invoking unintended significant changes to load networks designed to operate with the transistors. Intrinsic elements include drain-to-source breakdown voltage capability and peak current capability. As the need for higher frequency operation and higher power increased, constraints of key transistor parameters became difficult to produce in traditional silicon technology:

- High instantaneous transient (peak) current capability through the transistor
- Moderate breakdown potential across the transistor
- Low output capacitance

Only within the past few years have transistor manufacturers produced COTS transistors that meet the required capabilities necessary to operate in switch mode for microwave frequencies and



081107-N-1120L-072 RAMADI, Iraq (7 November 2008) Joint EOD Rapid Response Vehicles (JERRVs) assigned to Naval Mobile Construction Battalion (NMCB) 7's convoy security element are secured following an escort mission from a forward operating base. The Cougar-type JERRVs are employed by coalition forces for escort and logistics missions, and to protect personnel from IEDs. NMCB 7 is deployed to U.S. Forces Central Command to provide contingency construction support to coalition forces in support of Operations Enduring Freedom and Iraqi Freedom. (U.S. Navy photo by Mass Communication Specialist 2nd Class Michael B. Lavender/Released)

high-power output. Selection is still somewhat limited for designers.

New transistor technology known as gallium nitride (GaN) HEMTs—using state-of-the-art manufacturing processes with GaN on silicon carbide materials—now facilitates Class-E high-power amplifier (100-W) designs at ultrahigh frequencies. The design process for switch-mode amplifiers is radically different than linear amplifiers, so engineers have tended to continue using linear amplifier design techniques due to familiarity, rather than advance to the switch-mode designs. Today, the Class-E and Class-F unit power output (greater than 100 W) capability and upper frequency limitation is based on a lack of available HEMTs with the necessary parameter capabilities.

Most recently, transistor manufacturers have limited their investment in the Class-E amplifier solid-state switch market due to no commercial market mandate. An assortment of presently available HEMTs provides a low-power capability in terms of 1- to 10-W output power for Class-E amplifiers in the cell phone market. The need remains to continue

advancing in commercially manufactured HEMTs with key capabilities necessary to realize larger unit power output, hundreds of watts to a thousand watts, for practical implementation in DE systems.

POSSIBLE MULTIPLE APPLICATIONS

Directed-Energy Weapon Systems

Expanding on the vision of the next-generation DEW system mentioned at the beginning of this article, further imagine that EOD scouts detect a laser fluorescence signature of C4 high explosive and chlorine outgasses in the vicinity of an abandoned vehicle 2-km north of their current position. An electronic support measure (ESM) team on board an approaching clearing vehicle initiates RF jamming and electromagnetic surveillance procedures. Electronic specialists also scan the area with ground-surface differential thermography—particularly to detect possible buried IEDs and EFPs or their tiny command wires, crush wires, or pressure plates—while clearing a pathway to the abandoned roadside vehicle.

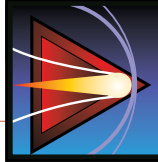

Upon arrival at a 500-m safe distance, the EOD specialists command the RF transmitter's robotic platform, also equipped with sensitive gamma-ray planar and computed tomography (CT) imaging to navigate toward and around the vehicle, interrogating every possible hiding place. It discloses an IED in the fuel tank. The specialist lifts the transmitter arming safety and commands the remote transmitter to radiate a prescribed dose of RF energy directed at a carefully chosen component of the vehicle-borne IED (VBIED) system. Without entering the vehicle, the advanced screening system detects and defuses the deadly IED buried within the rusty, metal vehicle chassis. Within minutes, the suspected VBIED threat is entirely neutralized, with absolutely no wounded warfighters or casualties.



Pictured here is the National Aeronautics and Space Administration/National Oceanic and Atmospheric Administration (NASA/NOAA) Geostationary Operational Environmental Satellite-P (GOES-P) launching from Cape Canaveral Air Force Station, Florida, aboard a Delta IV rocket procured by Boeing Launch Services on 4 March 2010. Built by Boeing Space and Intelligence Systems, GOES-P will provide NOAA and NASA scientists with data to support weather, solar, and space operations, and will enable future science improvements in weather prediction and remote sensing. Additionally, GOES-P will provide data on global climate changes and capability for search and rescue.

Mobile Ad-Hoc Wireless Network (MANET)

Beyond IED detection and neutralization, imagine an expeditionary unit on patrol, with each member equipped with an RF transceiver about the size and weight of a cigarette pack with an ultrahigh-efficient switch-mode amplifier. The miniature transceiver constantly communicates sensor intelligence, key vital signs, critical conditions, and location telemetry to a GEOSAT. This small switch-mode amplifier has the needed output power to reach an altitude of 35786 km, where the GEOSAT intercepts, collects, and retransmits this intelligence and situational awareness data to any command post in the world and to each member of the unit on patrol simultaneously. The expeditionary unit, spread out over a wide area with large interspacing, shares the situational awareness and intelligence data of each other at the speed of light. Thus, near real-time, worldwide communications with ubiquitous secure access from the battlefield is possible in a multiple-input, multiple-output (MIMO) architecture. The same system could provide a soldier-to-soldier MANET.

Next-generation switch-mode RF amplifier designs could also optimize payload weight and volume on board new communication satellites while supplying higher power density and making efficient use of the solar power supply budget. Improved switch-mode amplifier power output, when combined with enhanced antenna design, would minimize Earth-station antenna size requirements. The recently launched satellite shown at left demonstrates an example of the latest antenna technology.

LOOKING FORWARD

Miniaturizing next-generation DE systems opens up a whole new world of applications to support warfighters in ways unimaginable just a few years ago. Reduction of transmitter mass and volume, accompanied with high efficiency, creates a welcome trickle-down effect. Low profile, small, lightweight DE systems means:

- Less vulnerability to attack
- Greater mobility and maneuverability
- Simplified logistics with less fuel-supply demands
- Less impact on the environment

Clandestine operations, too, could be executed with greater ease and simplified logistics support. In the case of MIMO MANETs, miniaturized high-power density transmitters could further expand capabilities for the warfighter, enabling them to carry high-power transmitters to communicate with satellites or other supporting platforms. The

satellite industry itself could benefit from miniaturized switch-mode amplifiers with much higher power density microwave transmitters, resulting in reduced payload mass and volume; this also reduces Earth-station antenna gain and size requirements.

CONCLUSION

NSWCDD is meeting the demanding requirements of next-generation DE systems with Class-E RF transmitter switch-mode amplifiers designed to operate at ultrahigh efficiency, greater than 90 percent. Having discovered the key to next-generation DE systems, researchers at NSWCDD are focusing on the urgent need to counter IED systems with small, lightweight, highly efficient transmitters that use switch-mode amplifiers. Considering the multiplicity of additional applications, all advancements made in amplifier counter-IED applications can be transferred to other applications in the future. Accordingly, while the capabilities suggested in this article might seem somewhat far-fetched, in reality, they are realizable in the near term. It is projected that NSWCDD will soon have its first 250-W UHF amplifier unit prototype ready. These units will fit in the palm of an average-sized adult's hand and can be power combined to the level necessary for platform and mission requirements. A fully realized, fieldable DEW system prototype is possible in just a few years.

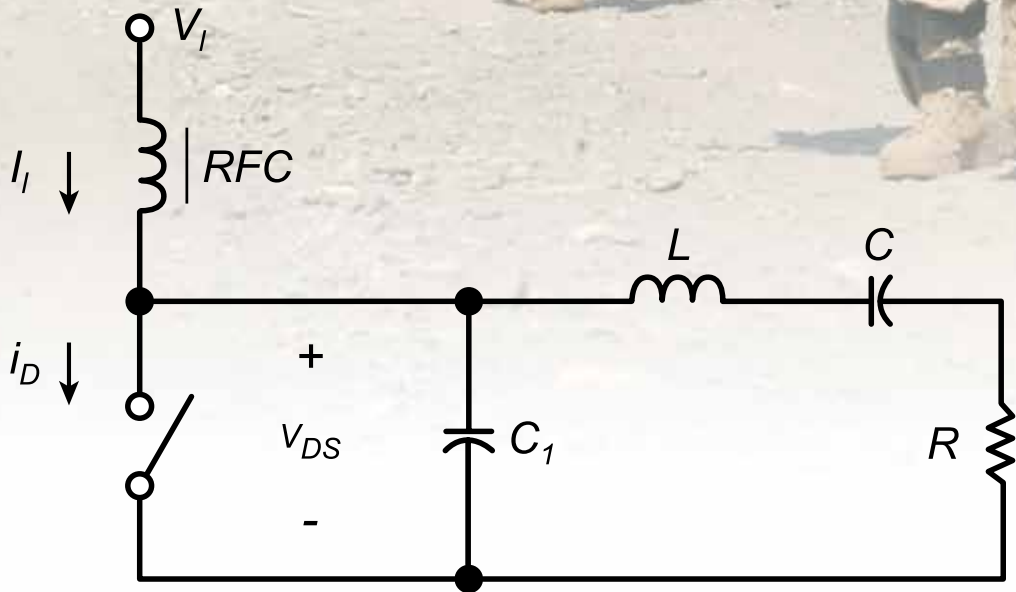



ACTIVE DENIAL ARRAY

By Randy Woods and Matthew Ketner

Active Denial Technology (ADT)—which encompasses the use of millimeter waves as a directed-energy, nonlethal, counterpersonnel weapon—has the potential to provide an important new escalation-of-force capability to U.S. operating forces. ADT projects a focused beam of 95-GHz millimeter waves to induce an intolerable heating sensation on an adversary's skin, repelling the individual with minimal risk of injury. More than a decade of research has established the biological and behavioral effects of ADT for large spot size systems, such as Active Denial System 1 (Figure 1). While the effects of this large spot size system have been successfully established, the technology that produces those effects has the potential to progress in a number of ways, particularly with the development of smaller, lighter, and lower-cost systems.

One research effort focuses on the development of smaller, lighter, and lower cost ADT demonstrators that produce commensurate “ADS-effects,” with effective spot size and power densities on target. In support of this effort, the Joint Non-Lethal Weapons Program (JNLWP) sponsored the Naval Surface Warfare Center, Dahlgren Division (NSWCDD) to develop a “smart target system,” which measures the millimeter-wave beam using fast-response, 95-GHz diode detectors. NSWCDD subsequently developed and tested the W-Band Beam Diagnostic Array to characterize the system's beam with a temporal resolution of 30 Hz and a high spatial resolution of 1 inch.

The current method of measuring the 95-GHz beam is to use carbon-loaded Teflon (CLT) to produce an average power beam image. This method works as the CLT is exposed to the system's beam. The material heats, over a period of seconds, proportional to the magnitude of the radio frequency (RF) field, resulting in an image as shown in Figure 2. After the exposure, the specific heat capacity of the CLT can be used with the temperature increase in the CLT to provide an indication of the total energy deposited in the material. This method produces a good representation of the average RF field; however, any peak variations in the beam are averaged out.

To allow for high temporal-resolution measurements of the 95-GHz beam, a high-density, 95-GHz diode-detector array was commissioned by the Joint Non-Lethal Weapons Directorate (JNLWD), and was designed and built by NSWCDD, with support from Millitech, Inc. The array consists of a center 11×11 matrix (shown in Figure 3) with four removable arms that can be attached (shown in Figure 4), resulting in a measurement area of approximately 1×1 m.



Figure 1. Active Denial System 1

Each element's profile consists of the individual horn antenna from the array, an attenuator, a detector, and a SubMiniature version A (SMA) connection to the digitizer circuitry. This configuration allows for the power received from the antenna to be attenuated and converted to a direct current (DC) output capable of being measured by an analog-to-digital converter. The machined antenna elements provide a uniform effective area for each element, allowing field strength (W/cm^2) to be converted into power received (W or dBm). The aperture antennas also provide an impedance match between free space and the waveguide system. A cross-sectional view of the array element is shown in Figure 5, followed by a signal flow diagram shown in Figure 6.

The basic principle of operation behind the array is that the derivative of the diode detector's power vs. output voltage curve is very

repeatable between detector elements. Therefore, when the detector elements arrived at NSWCCD, each detector element was paired with a variable

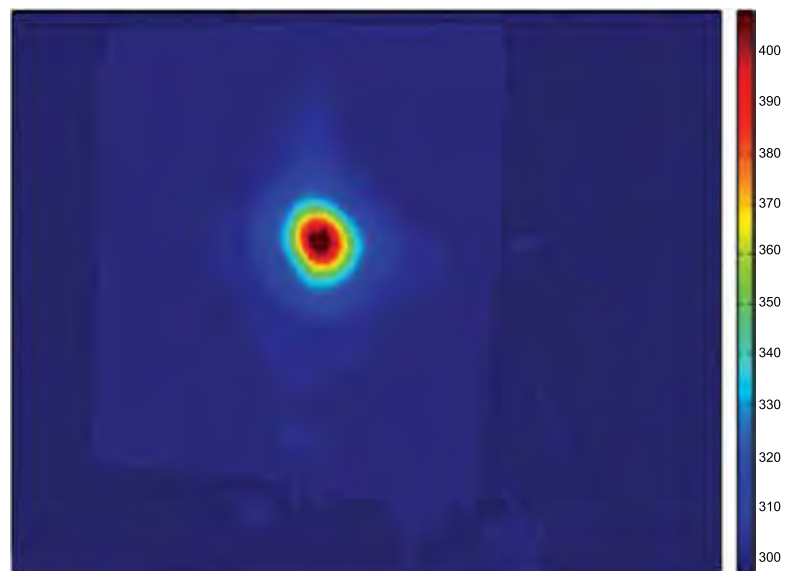

Figure 2. CLT Representation of Small, 95-GHz Spot

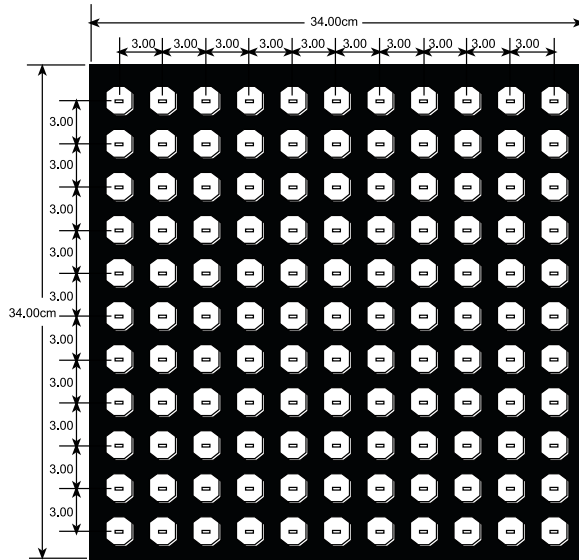
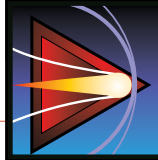

Figure 3. Main Array Face

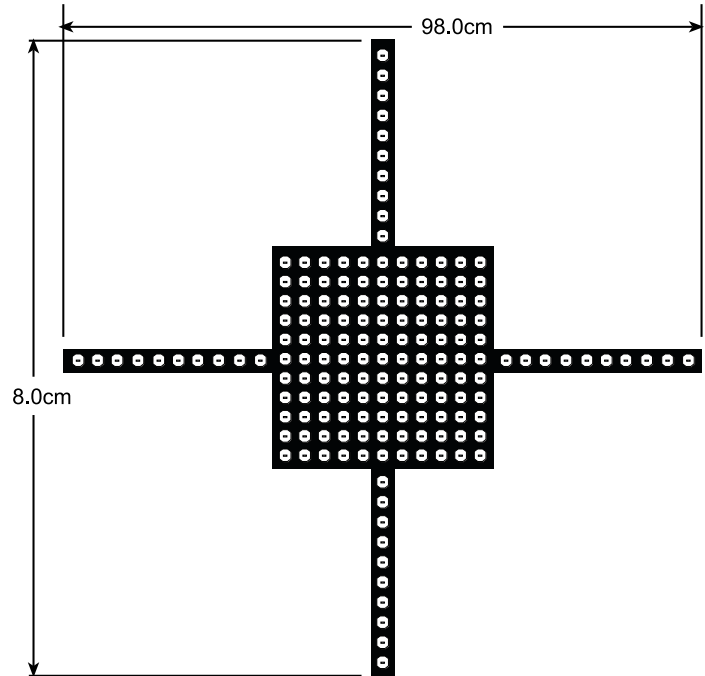

Figure 4. Full W-Band Array

attenuator and calibrated as a single unit. The calibration was accomplished by inserting a known input power of +5 dBm into the input of the attenuator and setting the DC output voltage at a predetermined millivolt (mV) output. This allowed the detector's individual offset voltages to be removed and caused the detectors to behave in a repeatable manner. The attenuator is able to be adjusted by varying the depth that the aluminum nickel card is inserted into the section of waveguide.

The final section of the electrical system converts the DC voltage output from the detectors to a digital signal to send back to the operator station. For this, it was determined that a 16-bit digitizer would be required to enable measuring the

microvolts output by the detectors on the low end of their range, while still allowing the digitizer to measure the full output voltage of 1.8 V for high-input powers. Also, due to the proximity of the operator to the array and overall system flexibility, it was determined that Ethernet communications would provide a sufficient means of reading the system data.

To display the data to the operator, a two-dimensional array is populated and displayed for the user (shown in Figure 7). This allows values to be

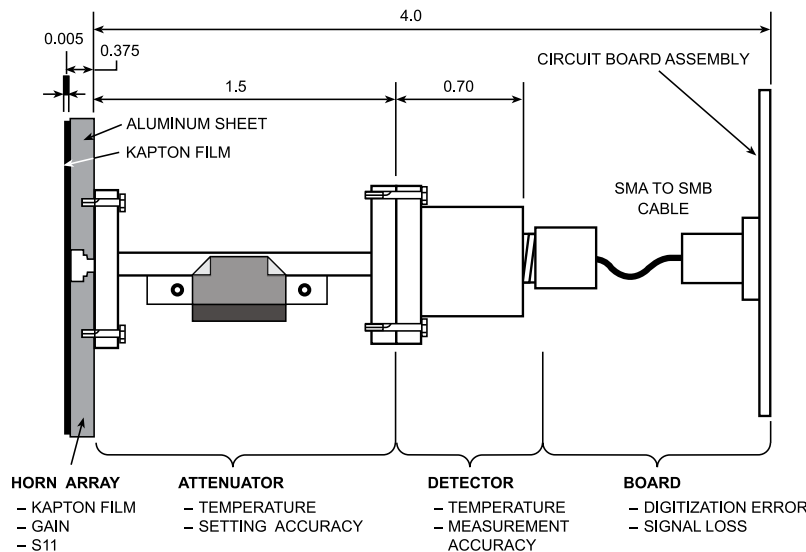

Figure 5. Cross-Sectional View of Array Element

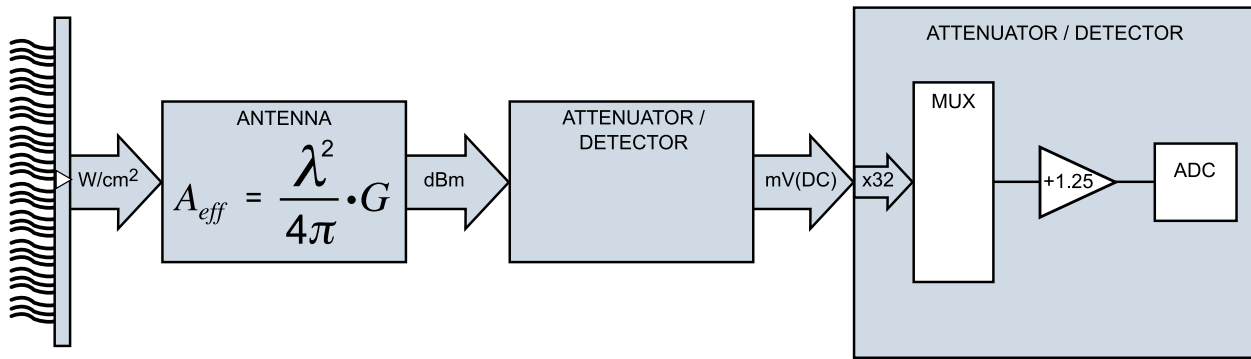

Figure 6. Signal Flow Diagram

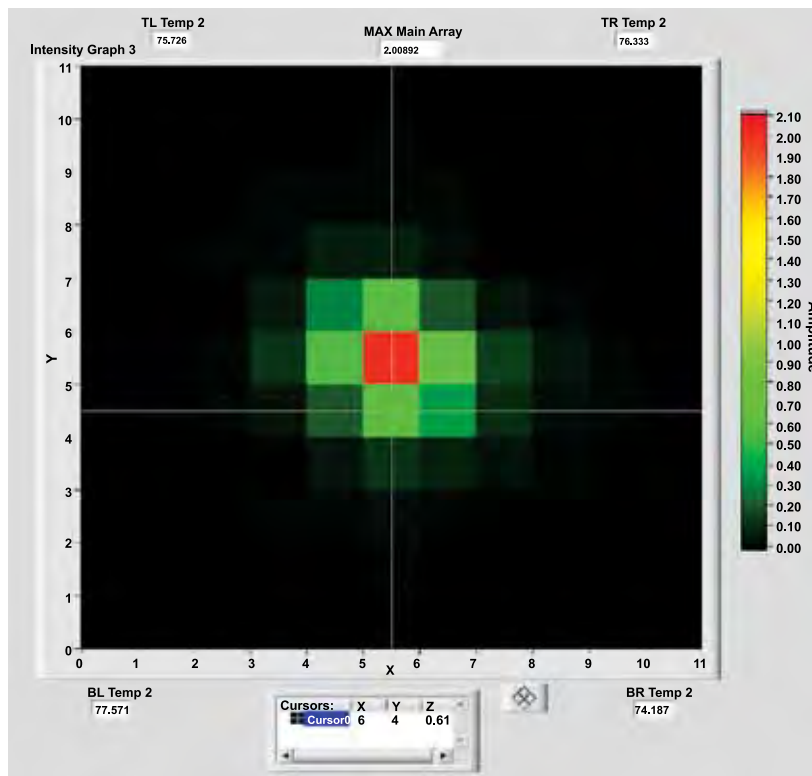

Figure 7. Array's Operator Interface Showing a Small Spot Source

read directly from the display corresponding to the watts per centimeter squared (W/cm^2) present at the array face. Data also is recorded so that it can be viewed later in a player application, such as a video file, or it can be viewed in a spreadsheet application, frame by frame. The data shown in Figure 7 is representative of small-source testing performed recently and very clearly shows the beam profile.

CONCLUSION

NSWCDD engineers successfully met the W-band array's design goals of providing a high temporal-resolution image of 95-GHz beams. The

system has been tested against two active denial systems, providing good agreement with the currently accepted methods, as well as valuable information regarding the system's beam characteristics. These accomplishments will allow future system development to take advantage of this better understanding to possibly reduce system size and increase the effective range. A better understanding of the 95-GHz beam helps to facilitate future ADT development for this much-needed, nonlethal escalation-of-force capability for U.S. warfighters, homeland defenders, and law enforcement personnel.

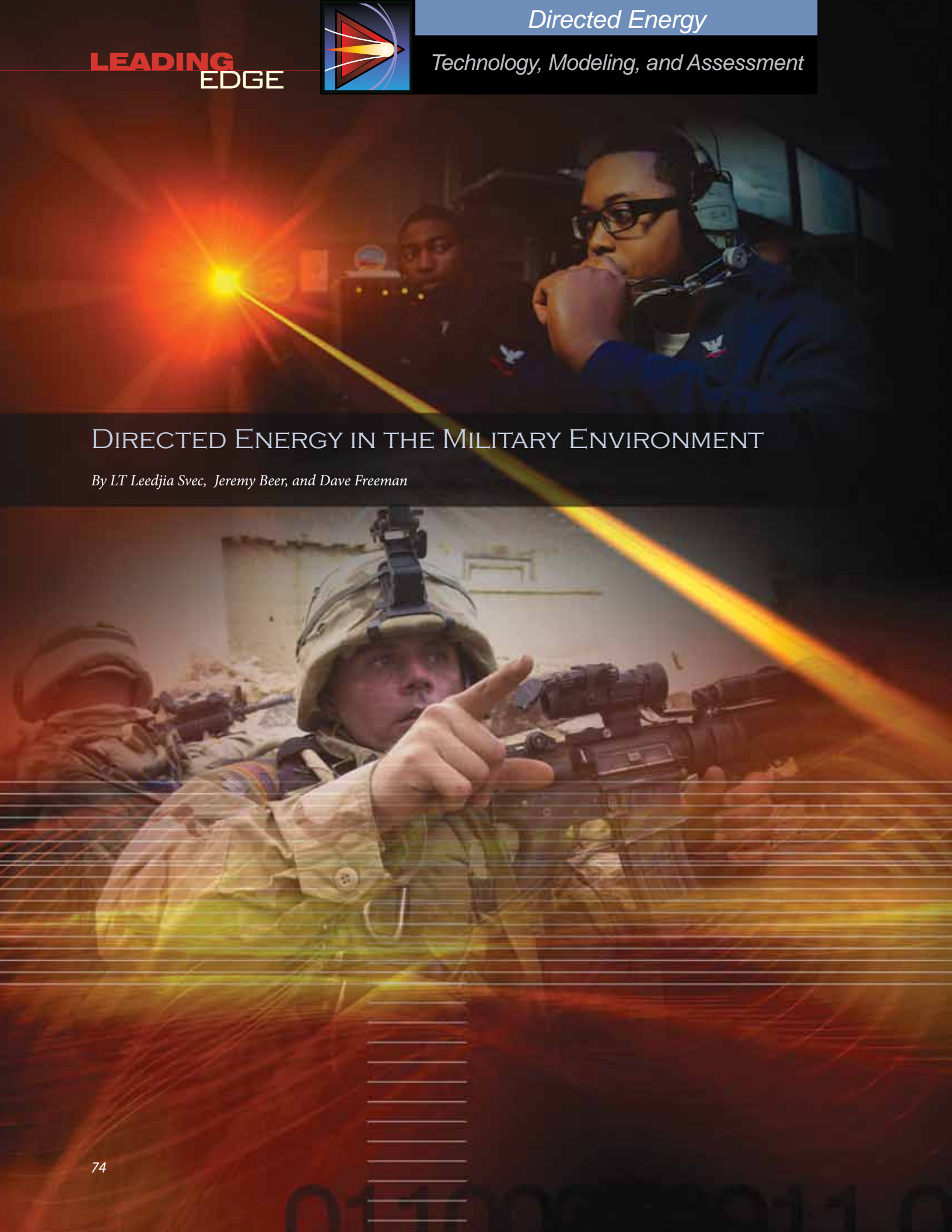

DIRECTED ENERGY IN THE MILITARY ENVIRONMENT

By LT Leedjia Svec, Jeremy Beer, and Dave Freeman



The military operates in the land, air, and maritime environments. In each of these environments, lasers and laser devices are increasingly being seen and used in a variety of ways. Accordingly, the military must protect itself and civilians from the potentially dangerous effects of lasers and other directed-energy devices.

Lasers are being used on the ground to determine the intentions of people who approach checkpoints and to dissuade aircraft from entering restricted airspace. Laser weapons are also being developed for use in the maritime environment. With the use of lasers comes the requirement for eye protection. The eye is particularly sensitive to lasers and its anatomy includes optical components that amplify the power of incoming light. Consequently, the potential for injury or blinding is great.

Naval Medical Research Unit – San Antonio (NAMRU-SA) is poised to lead the way in researching and testing laser glare devices and laser eye protection. The mission of the NAMRU-SA is to conduct medical, dental, and directed-energy biomedical research, which focuses on ways to enhance the health, safety, performance, and operational readiness of Navy and Marine Corps personnel, and addresses their emergent medical and dental problems in routine and combat operations. NAMRU-SA was officially commissioned on

6 May 2009 and is a subordinate command under the Naval Medical Research Center (NMRC) in Silver Spring, Maryland, reporting to Navy Medicine Support Command (NMSC) in Jacksonville, Florida. NAMRU-SA consolidates the Naval Health Research Center Detachment Directed Energy Bioeffects Laboratory, the Naval Institute for Dental and Biomedical Research in Great Lakes, and the NMRC Combat Casualty Care research function. As part of the Base Realignment and Closure (BRAC) 2005, NAMRU-SA has moved to Fort Sam Houston. Two new buildings that have been constructed are the Battlefield Health and Trauma Research Institute and the Tri Service Research Laboratory. A conceptual drawing of the NAMRU-SA Tri-Service Research Laboratory (to house directed-energy research) is shown in Figure 1.

Many factors must be considered when lasers operate in military environments. On the ground, lasers offer a greater likelihood of close contact exposure. In aviation and maritime environments, the mobility of lasers is limited to permanent fixtures on aircraft or ships, so target acquisition can be much more complicated. Often ignored, but just as important and common to all environments, are the psychological factors that need to be explored. These factors include clarifying intentions, communications, and effectiveness. In certain situations,



Figure 1. Naval Medical Research Unit – San Antonio Tri-Service Research Laboratory at Fort Sam Houston, San Antonio, Texas (artist's concept)

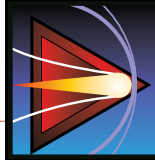

sometimes lasers are coupled with other modalities, such as auditory instructions.

On the ground, laser exposure has been shown to interfere with driving vehicles, making color judgments, and target shooting. In aviation, lasers can interfere with pilot vision, causing afterimages, glare, or temporary ocular injury, with attendant effects on navigation and control. In the maritime environment, lights frequently are used to signal a variety of messages, from direction (left, right, etc.) to more complicated messages such as “man overboard.” More prolific use of lasers underscores the need for laser eye protection, a dynamic area of research, which must respond to changing threat

wavelengths and changing environments. Figure 2 shows NAMRU-SA personnel executing an operational field test at Kennedy Space Center, July 2009.

Recent studies undertaken by NAMRU-SA have investigated the use of laser dazzlers on sailors in small boats.^a In these studies, participants were exposed to the laser glare at different angles and distances, in both day and night conditions. Study protocols were approved in accordance with the Institutional Review Board in compliance with all applicable federal regulations governing the protection of human subjects. Participants were given a survey assessing their subjective response to the laser, as well as a more objective visual eye chart. The



Figure 2. NAMRU-SA personnel execute operational field test at Kennedy Space Center, July 2009, in which a nonlethal laser prototype is evaluated for power delivery (stability and beam propagation) at range and human visual effectiveness aboard a maritime target.

results suggested that participants were most affected by the laser at night when they were looking straight at it (as opposed to many degrees away) and at the closest exposure distances. The most surprising finding, however, was that some participants reported being drawn to the laser rather than away from it, especially at farther distances. Participants remarked that they couldn't tell what the signal was, so they would want to go closer to find out. This illustrates that the assumption (by some)—that distant laser lights will deter and repel innocent mariners—might not always be true. Further research is needed to verify this finding, however, before employing laser glare devices in the maritime environment. Figure 3 shows NAMRU-SA personnel executing operational field tests, which were conducted at Cheatham Annex, Virginia, and Panama City, Florida, in 2008–2009.

These studies also brought the factor of communication to light. Participants remarked that “green is not a threatening color,” and some thought “it could be a signal for help.” Many felt curious about the “blinking light” used in the study and would go closer or try to contact the vessel to determine the intent of the message. Green lasers are used because they are more visually salient; however, they may not be as psychologically salient. Participants remarked that if the signal were paired with another signal, such as an auditory one, then the message of “warning” or “do not come closer” might be clearer.

Lastly, these studies brought to light the matter of effectiveness. Laser glare devices are used to stop or alter the behavior of the recipient, but one study yielded mixed results. At close distances, participants noticed the signal, felt affected by it, and reported that their behavior changed in the manner desired by the person pointing the laser. But at greater distances, behavior might not change. Thus, these findings need to be replicated in different maritime scenarios in order to be truly useful in developing laser glare devices. This particular study

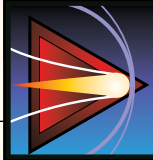

Figure 3. A compact hand-held laser is evaluated for effectiveness in maritime defense against small-boat attacks.

was encouraging regarding the effectiveness and visual usefulness of glare devices, but it brought up new questions about their psychological impact on behavior. Resolving these questions must be an integral goal of technical research and development studies to determine the operational effectiveness of directed-energy devices, not just for the maritime environment, but for all military environments.

ENDNOTE

- a. Results and technical reports are available upon request from the corresponding author or from the NAMRU-SA Public Affairs Officer.



DIRECTED ENERGY USING HIGH-POWER MICROWAVE TECHNOLOGY

By Jacob Walker and Matthew McQuage

The Directed Energy Warfare Office (DEWO) and Directed Energy Division at the Naval Surface Warfare Center, Dahlgren Division (NSWCDD) merge past research and data with continuous innovation in the field of high-power microwave(s) (HPM) to address the critical need for nonlethal, nonkinetic weapons. HPM weapons can be described as nonkinetic devices that radiate electromagnetic energy in the radio frequency (RF) or microwave spectrum. They are designed to disrupt, deny, degrade, damage, or destroy targets. In essence, this is achieved when high-power electromagnetic waves propagate through air and interdict targets by traveling through the exterior layers of structures and coupling energy to critical electronic components. Since effectiveness against a wide range of targets is the goal, HPM has become a collective term for various technologies: wave shapes, source frequencies, and the distribution of varying signal bandwidths. It is the objective of HPM research and assessment, therefore, to address targets for which no engagement option currently exists. NSWCDD is working to identify optimal HPM mission platforms and move relevant technologies into the field.

HPM INITIATIVES

NSWCDD has actively pursued HPM research since the advent of the field in the 1970s. Since then, scientists and engineers have conducted HPM research and development in many areas, including hydrogen spark-gap switching, spiral generators, and related technologies. More currently, the Directed Energy Division developed a variety of high-power wideband RF systems based on pulsed power and Marx generators (Figure 1). In addition to the extensive work accomplished in HPM and RF source development, NSWCDD contributed substantially to the area of counter-HPM vulnerability assessments. Researchers developed site assessment guides and threat brochures, as well as a number of wideband RF sources, to determine the susceptibility of electronic equipment to high-power RF interference. This latter effort involved assessing and exploiting the weaknesses of specified electronic targets to various HPM and RF threats. Data gleaned from these efforts was then used to support optimized prototypes and system designs employing effects-based design methodology. NSWCDD utilized these wideband RF sources to determine the susceptibility of a multitude of military



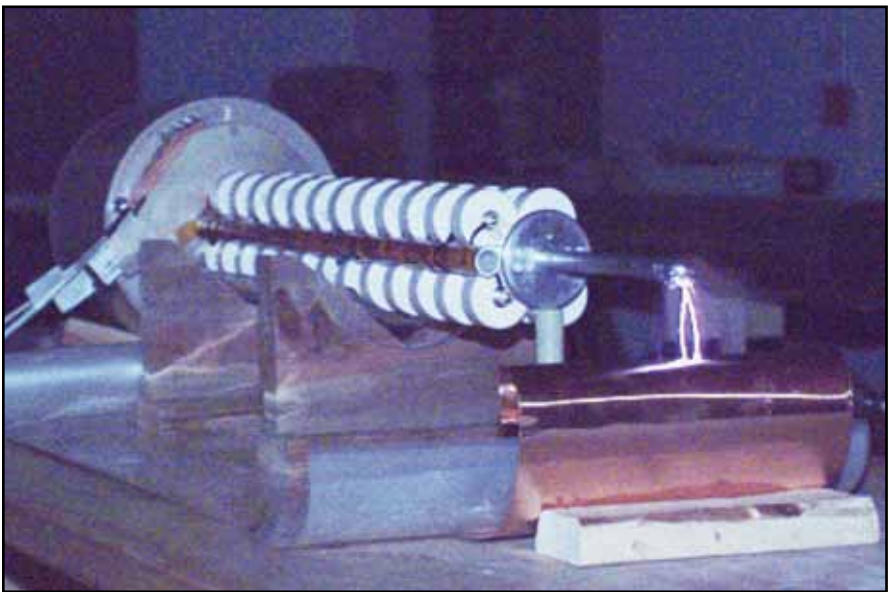
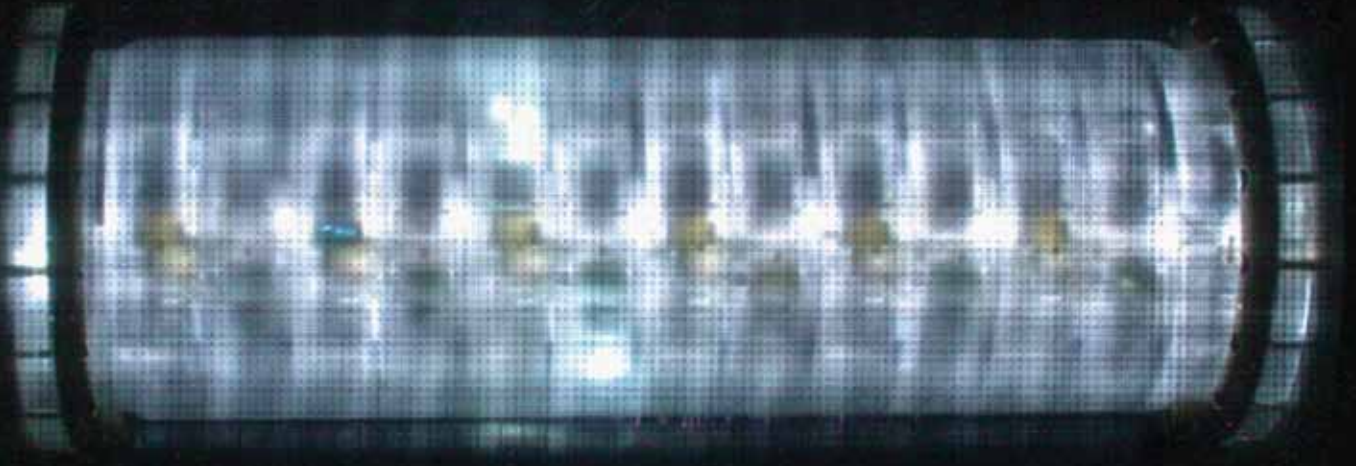
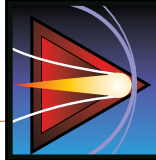

Figure 1. Examples of NSWCCD Marx Generators



and electronic infrastructure equipment to high-power RF interference.

**HPM COUNTERATTACK
OPERATIONAL OVERVIEW**

Research in support of HPM-driven electronic attack increased significantly as the demand for nontraditional warfare emerged. Traditional kinetic weapons often are of limited value in peace-keeping missions, for example, as today's enemies frequently are embedded within civilian populations and structures. This creates the need for novel HPM technologies that minimize

the risk of collateral damage while effectively neutralizing threats. Dahlgren researchers conduct HPM system research and development—as well as lethality and weapon effectiveness assessments—to address this need while developing technologies against a wide variety of electronic targets. These projects leverage NSWCDD's assets, including the Maginot' Open Air Test Site (MOATS), state-of-the-art RF diagnostics, and modeling and simulation tools to identify applications and platforms in which HPM technologies can be employed. Figure 2 shows a computer model of the MOATS facility and a modeling and



(a)

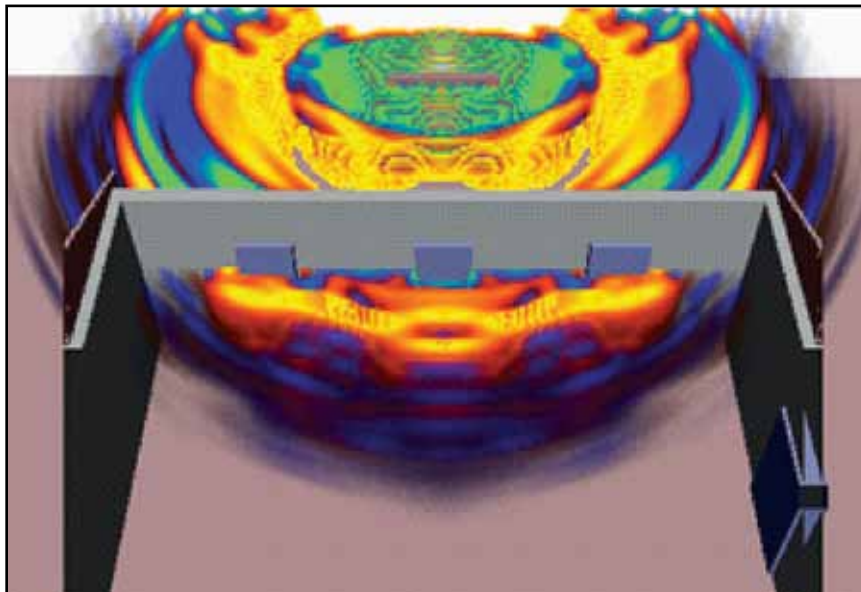

(b)

Figure 2. Modeling and Simulation Depicting (a) NSWCDD Test Facility and (b) Simulation of Radiated RF

simulation graphic depicting the RF emitted by an HPM dipole antenna.

Potential platforms for HPM integration include: man-portable, aerial, vehicle, and vessel-mounted systems. These platforms all provide unique methods for delivery of HPM sources. For example, aerial delivery—which, in many ways, is the most challenging due to size and weight constraints—can increase the effective range of these systems and can engage multiple targets at close range without endangering personnel. Likewise, vehicles and vessel-mounted HPM systems provide a way for law enforcement and the military to stop vehicles in chase scenarios almost as soon as they begin. The goal of all of these projects is to provide military forces with the ability to employ nonkinetic, electronic strike technologies against an adversary's electronics.

The DEWO and Directed Energy Division are uniquely positioned to provide numerous capabilities for in-house development while engaging with the private sector to test and provide feedback on HPM systems developed externally. In the past decade, NSWCDD has evaluated several

HPM systems at Dahlgren to determine their effectiveness against various electronic targets while maintaining the Office of the Secretary of Defense's Tri-Service RF Directed Energy Weapon (DEW) Database. This database contains all effects data collected from directed-energy tests performed within the U.S. Air Force, Army, and Navy.

CONCLUSION

NSWCDD continues to pioneer HPM source development and lethality and integration studies, leading to the demonstration and delivery of prototype capabilities. It also is committed to researching and developing critical subsystems for HPM delivery. By leveraging numerous target assets and sophisticated diagnostic equipment—in conjunction with MOATS—NSWCDD has positioned itself at the forefront of HPM electronic attack, leading the way in the development and delivery of these capabilities to the warfighter.

ACKNOWLEDGMENT

Nancy Muncie, Bowhead, contributed to this article.





LASER COUNTER ROCKET, ARTILLERY, AND MORTAR (C-RAM) EFFORTS

By Michael Libeau

Mortars and rockets are common weapons confronting U.S. troops abroad. Insurgents fire the inexpensive projectiles into populated areas, intending to kill or injure service members and to inflict physical damage. While kinetic solutions like guns and missile interceptors are used to counter rockets and mortars, laser counter rocket, artillery, and mortar (C-RAM) systems present a promising solution to counter these challenging threats in the near future.

Scientists and engineers at the Naval Surface Warfare Center, Dahlgren Division (NSWCDD) have been researching, developing, testing, and evaluating laser C-RAM systems through collaboration, modeling and simulation, and experimentation. The Joint Technology Office (JTO) and the Directed Energy and Electric Weapons Program Office (PMS 405) sponsored the first year of these initiatives in 2007. Consecutive and current work has been sponsored by the Office of Naval Research (ONR) Expeditionary Maneuver Warfare and Combating Terrorism S&T Department.

BACKGROUND

In preparation for the development of a laser C-RAM system, an understanding of the vulnerability of rockets and mortars to laser energy was crucial. Engineers from NSWCDD and the U.S. Army Space and Missile Defense Command (SMDC) collaborated on laser C-RAM efforts. Engineers analyzed the RAM threat and examined a variety of targets, assessing RAM vulnerabilities to laser energy by utilizing theoretical, numerical, and experimental work. They then developed theoretical models that captured the physics of the laser-induced failures of targets containing high explosives (HE). Additionally, NSWCDD engineers enhanced lethality simulations using a tool called the Effectiveness Toolbox to model engagements of RAM targets with laser energy. Figure 1 shows a screen capture from the Effectiveness Toolbox.

The resulting simulations included results from a laser atmospheric propagation model and a thermal model to determine the effect of the laser energy on the target. The simulations also incorporated target trajectories necessary for modeling the changing laser conditions on the target resulting from the engagement of a ballistic target. Subsequent to modeling these effects, live testing was performed. Figure 2 shows the lasing and destruction of a RAM target during live testing.

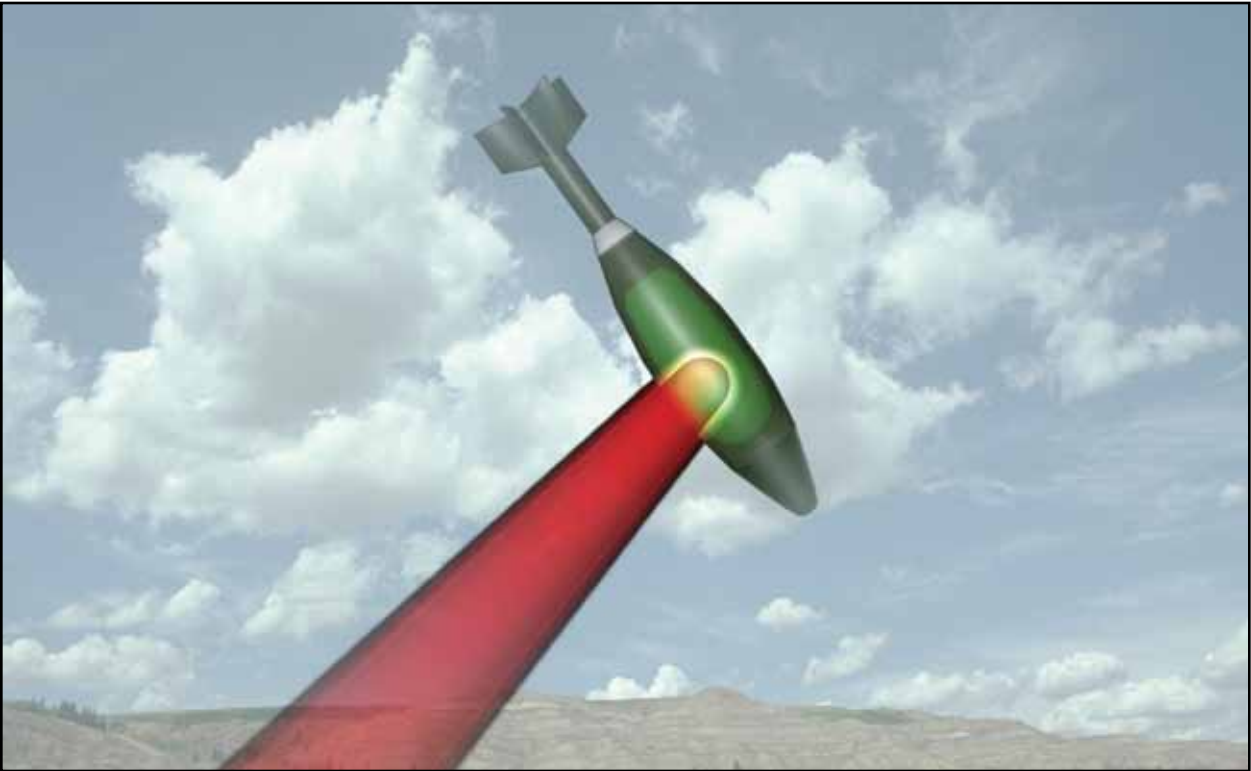

Figure 1. Screen Capture from the Effectiveness Toolbox Showing the Laser Engagement of a Mortar Target

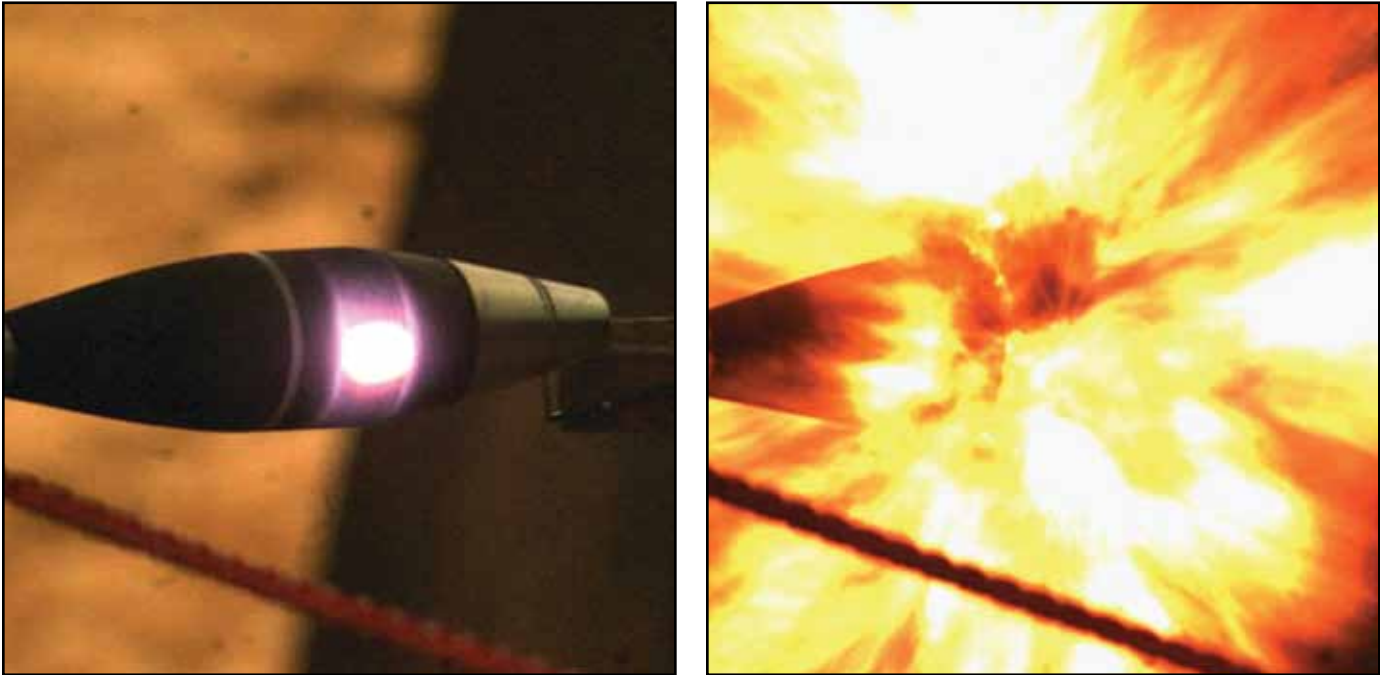
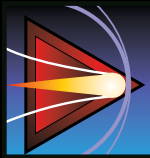

Figure 2. Explosive Target is Destroyed with NSWCCD's Fiber Lasers



NSWCDD engineers conducted two large experimental tests to determine the vulnerability of HE targets to laser energy using NSWCDD's High-Energy Fiber lasers. The first test was conducted jointly with SMDC. During these two tests, over 40 RAM targets were destroyed under different laser conditions, producing significant information on laser lethality. Researchers measured the failure times of multiple targets for different laser powers, spot sizes, incidence angles, and aimpoints. The experimental data yielded by the tests increased engineers' understanding of the vulnerability of targets containing energetic materials. This data was then used to benchmark predictive models.

Future tests are planned with additional HE targets to further the knowledge of RAM vulnerability. These tests are controlled and conducted carefully to ensure that good data is obtained. Accurate measurements of laser power on the target and the resulting target failure times must be made during the tests. To that end, NSWCDD engineers leverage Division-wide expertise in lasers and optics with its long history of explosives testing to achieve meaningful test results. NSWCDD personnel have been instrumental in improving techniques to measure the spatial profile of laser power on a target. The spatial distribution of laser power on a target is critical to understanding the target's failure. Figure 3 shows a laser beam's spatial power distribution measured during a test.

ONGOING LASER C-RAM INITIATIVES

Recent advances in fiber lasers have increased the power outputs of these rugged, solid-state devices. Both government and contractor efforts are examining the application of commercial off-the-shelf (COTS) lasers and other electric lasers for application into advanced weapon systems. The Navy's Laser Weapon System (LaWS) Program, for example, is examining a laser system built around efficient fiber lasers. This is significant because a high-energy fiber laser system offers two critical advantages over gun and missile interceptor C-RAM systems. First, the laser has a great depth of magazine since it requires only electricity for operation. Consequently, unlike a gun system, which has a limited supply of ammunition, a laser system is limited only by its supply of electrical energy. Second, a laser system offers a cost per kill that is significantly lower than alternative systems because only electricity is being expended instead of gun ammunition or a costly missile interceptor. This low cost per kill also better matches the low cost of the RAM target being engaged.

High-Energy Fiber Laser C-RAM systems will provide significant advantages in defeating the RAM threat while augmenting existing C-RAM solutions. More importantly, laser C-RAM systems will help protect members of the armed forces from the inexpensive, yet often deadly threats posed by rockets and mortars.

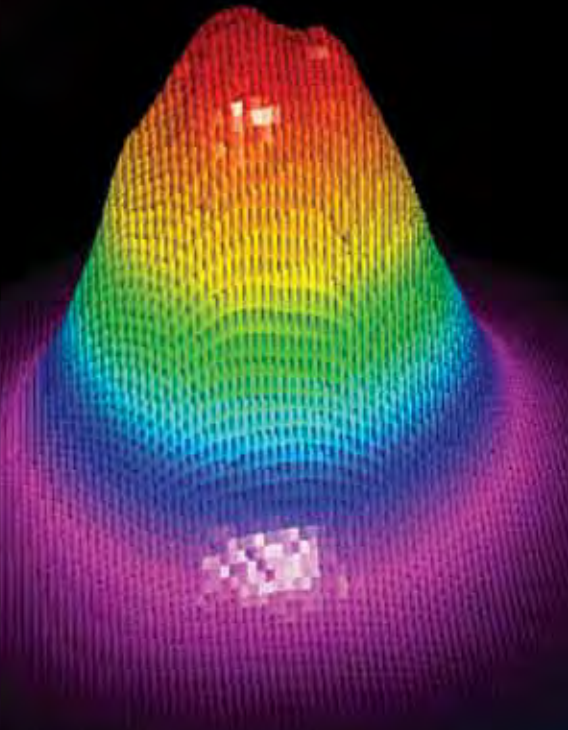
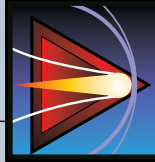

Figure 3. Laser Power Spatial Variation from a C-RAM Test





MULTIFREQUENCY RADIO-FREQUENCY (RF) VEHICLE STOPPER

By Stephen A. Merryman

The widespread use of vehicle-borne improvised explosive devices (VBIEDs) in Iraq and Afghanistan has resulted in large numbers of military and civilian personnel being killed or injured. Consequently, the Joint Non-Lethal Weapons Directorate's (JNLWD) top priority is to identify, investigate, and develop technologies and capabilities to non-lethally stop both vehicles and vessels outside of minimum "keep-out ranges" (i.e., ranges where the rules of engagement would dictate the use of lethal force) and to mitigate the blast effects from a VBIED.

One of these technologies is the multifrequency Radio-Frequency (RF) Vehicle Stopper (RFVS), a high-power microwave (HPM) weapon under development at the Naval Surface Warfare Center, Dahlgren Division (NSWCDD). A prototype RFVS system, designed to meet the mission criteria for fixed-checkpoint protection and compound protection, is slated for completion in FY13. Science and technology (S&T) work continues in parallel to the prototype system's construction to broaden its applicability to include convoy protection and the establishment of a quick safe zone. This article describes the 4-year research effort that resulted in the specification of the RFVS system design. Figure 1 shows an illustration of a candidate RFVS platform with the system set up for fixed-checkpoint protection.

The RFVS system uses high-power magnetron tubes to generate intense RF pulses that interfere with a vehicle's electronics, rendering it temporarily inoperable. The engine cannot be restarted while the RF is on but is readily restarted once the RF is turned off. Thus, the RFVS system allows for the maintenance of a safe keep-out zone in situations that might otherwise require the use of lethal force. The defined measure of success for this system is a demonstrated, effective capability against more than 80% of the candidate target-vehicle-class list, which includes passenger cars and large vehicles.

As a nonlethal capability, the effects to the target vehicle are short term and almost always reversible, so that the vehicle is not stranded, which would burden the warfighter with the task of its removal. Moreover, as with all directed-energy weapons, the RFVS system delivers energy at the speed of light. In contrast with other nonlethal vehicle stopping concepts and systems, however, RFVS does not need to be pre-emplaced and has a limitless magazine.



Figure 1. Illustration of Candidate RFVS System Setup for Checkpoint Protection

BACKGROUND

Using HPM or RF energy to stop an automobile engine is not a new concept; it has been under investigation for some time in private, academic, and military sectors. To that end, the RFVS program leveraged as much historic work as possible while collaborating with academic and military laboratories and while aggressively pursuing contacts in the automobile industry to gain knowledge of vehicle electronic design and function.

In 2005, the JNLWD funded the then-Directed Energy Technology Office (DETO) at NSWCDD to perform an extensive reverberation chamber test series to characterize the vulnerability of a representative cross section of automobiles to a wide range of HPM source frequencies.^a The purposes of the tests were twofold. First, the applicability of the Army's Ground Vehicle Stopper (GVS) data set needed to be established for newer vehicles, and second, a thorough, source-technology independent assessment of vehicle vulnerabilities

needed to be performed. The rationale behind the latter was to establish vehicle vulnerabilities without inadvertently biasing the process. Only after the full assessment was performed would factors such as concept of operations (CONOPS) and system requirements come into play. Figure 2 is a photograph of reverberation chamber testing.

Over the past decade, a significant number of private, academic, and military laboratories have investigated the susceptibility of automobiles to HPM energy. The range in approaches spans the gamut from isolated component testing, through direct injection and radiated testing of electronic control units (ECUs), and continuing through full vehicle radiated testing. Each of the different test methods has its strengths and weaknesses. Testing of isolated ECUs in controlled laboratory conditions is arguably the best way to determine exactly how a specific unit is responding to the RF. However, whether or not the identified susceptibilities continue to hold true when the unit is in place in a

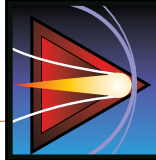

Figure 2. Vehicle on a Dynamometer in the NSWCCD Reverberation Chamber

vehicle, or whether the results apply to other vehicles' ECUs, remains a significant question that limits the applicability of the results.

Full vehicle testing and failure analysis of the ECU can be a daunting task. That said, full vehicle testing affords the advantage of ensuring that the response is commensurate with expectations of genuine engagements. The test approach one chooses to take depends upon resources, test facility availability, and most importantly, the objectives of the program. For the RFVS program, the objectives were to identify an HPM waveform that is effective against a broad class of the candidate target vehicles and to ensure that the identified waveform could be generated with a source that can be packaged in a footprint and cost amenable to military users. To meet the program's objectives, the

RFVS program chose to invest the majority of its resources in full vehicle testing. While the focus of the effects testing portion of the RFVS program has remained on full vehicle testing, both time and resources have been devoted to fostering and maintaining connections with academia and the auto industry. There is concerted effort to keep abreast of the latest trends in automotive technology, to ensure that the current RFVS system design will continue to be effective against future vehicle designs, and to leverage all research that might aid in future RFVS designs.

SYSTEM OPERATION

The majority of current HPM system concepts employ a narrowband, single-frequency HPM source. In contrast, RFVS utilizes multiple HPM

frequencies. The rationale for using multiple frequencies is associated with increased system effectiveness. Electromagnetic (EM) energy can be used to disrupt or damage an electronic target. In order for the energy to affect the electronics, however, it must be able to reach a critical component(s) inside the target. This involves a process referred to as coupling. Different EM waveforms are more or less effective against specific targets depending, in part, on their frequency, as different frequencies couple better or worse depending on varying target geometries. To be specific, each piece of electronics has specific resonance frequencies that most effectively facilitate coupling energy to the target. Unfortunately, these resonant frequencies can be unique to each piece of equipment. Consequently, a single-frequency waveform might be very effective against one target, but less effective against another target. Therefore, a system that utilizes either a sweep of frequencies or multiple frequencies will be more effective against a larger target set. This is not a novel idea, but rather one that has been readily acknowledged within the HPM community for some time and fervently embraced by the RFVS program. Current technology limitations prohibit high-power-swept frequency sources as viable options, leading to the idea of a multifrequency source. The more frequencies that are used, the

more effective the system; however, a trade-off is made with system size and cost as the number of source frequencies is increased.

BRASSBOARD SYSTEM

After completion of the exhaustive vehicle effects characterization testing in 2006, the RFVS program identified the optimal number of frequencies needed to meet mission requirements. It then used this information in the design and construction of the Brassboard System. The purpose in constructing the Brassboard System was to demonstrate the benefit of the multifrequency approach and the ability to meet mission objectives with specified power on target requirements. Construction of the RFVS Brassboard System began in 2007 and was completed in 2008. The Brassboard System was not constructed with specific system footprints in mind. Thus, the antenna and conex used are significantly larger than those in the prototype design. The RFVS team collaborated with a Marine Corps service representative identified by the JNLWD to flesh out the specifics of the mock checkpoint to be used in the RFVS Brassboard System Demonstration. Figure 3 provides a diagram of the checkpoint setup used in the RFVS Brassboard Demonstration. Figure 4 provides photographs of the RFVS Brassboard System.

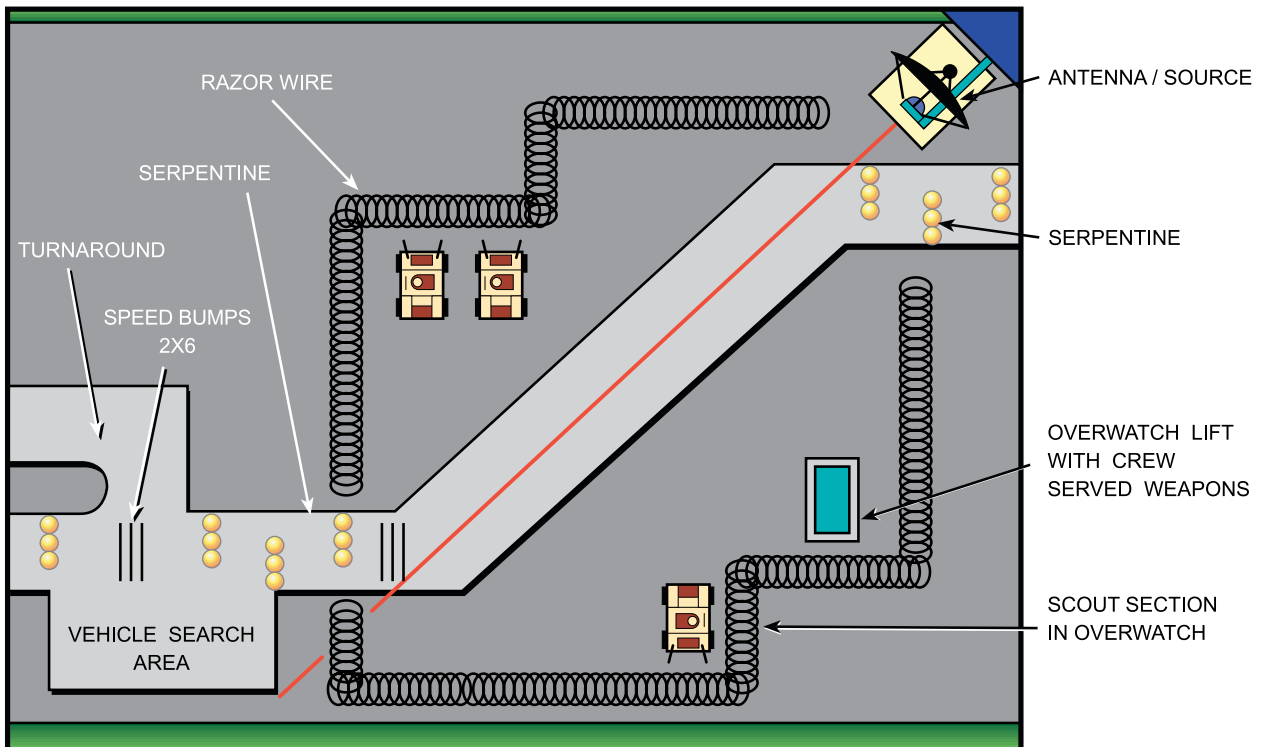
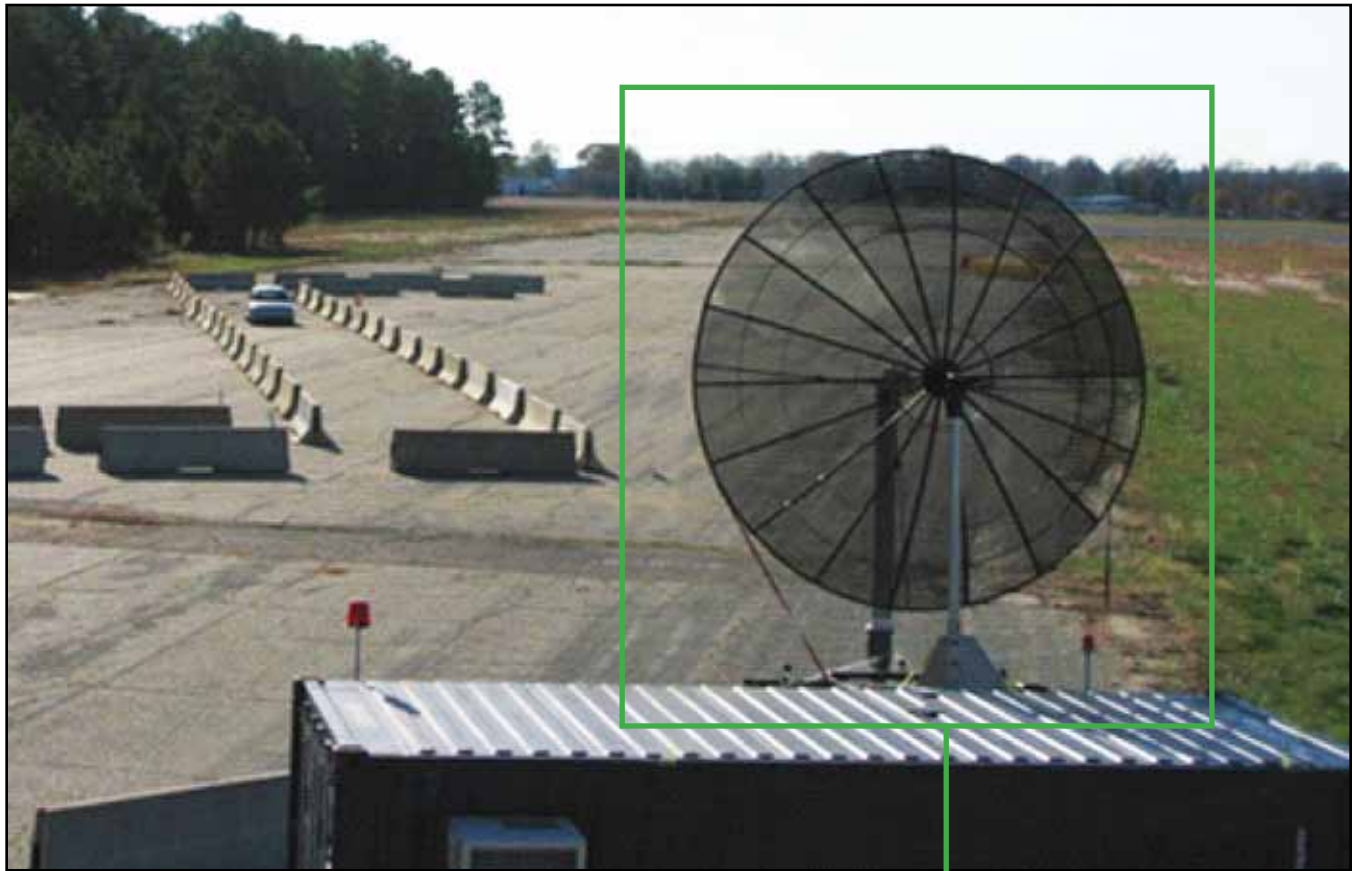
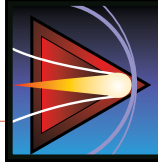

Figure 3. Schematic of Checkpoint Setup



Demonstration Test Setup



Figure 4. Photograph of the RFVS Brassboard System and Demonstration Setup

The Brassboard System Demonstration was conducted in Spring 2008. The Demonstration was a success, and funding for the RFVS prototype was consequently approved. To date, 42 passenger vehicles (cars, pickup trucks, vans, and sport utility vehicles (SUVs)) and 3 large trucks (dump truck and tractors) have been tested as part of the RFVS program.

WAY AHEAD

The JNLWD continues to work with the Directed Energy Warfare Office (DEWO) toward the development of a fieldable multifrequency RFVS system. Once the capability is fully developed,

tested, and certified ready for operational use, warfighters and civilians alike will benefit greatly. Lives will no doubt be saved using the ability to stop vehicles nonlethally and mitigate the blast effects from VBIEDs.

ACKNOWLEDGMENT

Dr. Cynthia Ropiak (SAQ Consulting) contributed to this article.

ENDNOTE

- a. The Directed Energy Technology Office (DETO) was renamed the Directed Energy Warfare Office (DEWO) in August 2009. For reference, see the charter for the DEWO, NSWCDD, 17 August 2009.



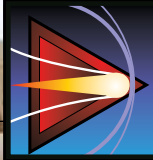

HIGH-POWER ELECTRICAL VEHICLE-STOPPING SYSTEMS

By Jordan Chaparro and Melanie Everton

The military needs devices that can safely and reliably stop or arrest vehicles. The primary concern is security at entry control points and vehicle check points similar to the one shown in Figure 1. In such scenarios, it is desirable to be able to stop unauthorized vehicles at predefined standoff ranges to protect personnel, equipment, and critical infrastructure.

Both the military and civilian law enforcement agencies face similar issues with chase scenarios, where concerns over bringing an offending vehicle to a stop without killing or injuring innocent civilians, or causing collateral damage, often prolongs high-speed pursuits. That said, currently employed nonlethal options for arresting vehicles have significant logistical limitations and carry a high cost per use.

The Naval Surface Warfare Center, Dahlgren Division's Directed Energy Warfare Office (DEWO), under the sponsorship of the Joint Non-Lethal Weapons Directorate (JNLWD), investigated compact systems designed to couple high-power electrical impulses to a target vehicle to stop its engine. Such systems are highly portable, can operate remotely, can be deployed quickly by a two-man team, and can engage hundreds of targets before requiring any significant maintenance.

SYSTEM OVERVIEW

Conceptually, electrical vehicle-stopping systems are fairly simple devices. The systems use several stages of energy compression to take a low-peak power source—like a battery pack—and create very intense, short-duration, oscillating electrical impulses. The block diagram, shown in Figure 2, illustrates the principal components of such a system.

A high-energy density, 300-V lithium battery pack, similar to what might be found in a hybrid vehicle, serves as the prime power source for the device. These batteries are capable of driving the system for hundreds of engagements before requiring recharge.

The direct current bus from the batteries is stepped up to several kilovolts in order to charge a capacitive voltage multiplier, such as a Marx Generator, Spiral Line Generator, or Tesla Transformer. Once triggered, these generators charge a resonant circuit to hundreds of kilovolts which, when switched, generate the desired oscillating waveform. Coupling this electrical pulse to a target may be accomplished by direct electrode contact, by radiating the waveform from a broadband antenna structure, or by a combination of both methods.





Figure 1. An Azerbaijani Soldier Guarding Entry Control Point 1 at the Haditha Dam in Support of Operation Iraqi Freedom

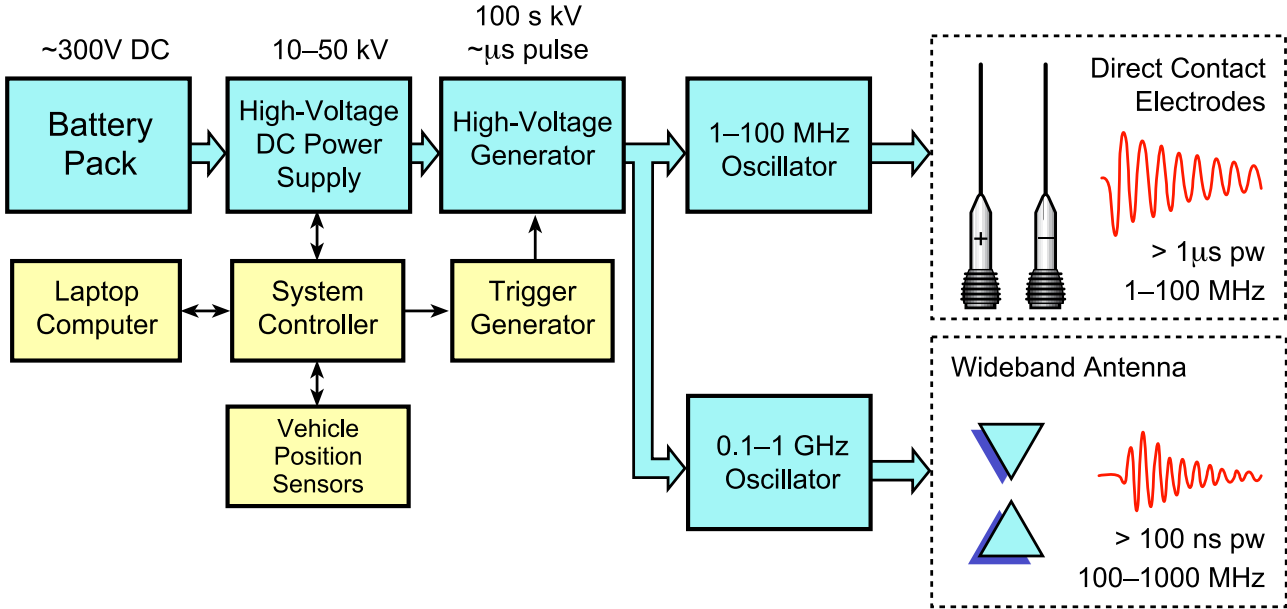
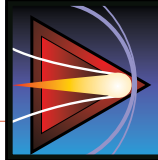

Figure 2. System Block Diagram for Generic Electrical Vehicle-Stopping Systems



The system is monitored and controlled by an integrated system computer. A laptop computer, remotely connected to the system controller through either fiber optic or a wireless network, can be used to arm the system. At this point, motion detection sensors trigger the pulse train upon the targeted vehicle. The laptop can also be used to monitor the system's status, change system parameters, and receive data collected during the last engagement event.

A conceptual rendering of how such a system might look when in use is shown in Figure 3. Traffic would be funneled with barriers to a single lane. When not engaged, the system electrodes would sit flush with the roadway unit, with an exposed height of less than 3 inches. When required, the electrodes could be released to make contact with a vehicle's undercarriage and deliver the electrical impulses.

COMPARISON WITH EXISTING SYSTEMS

Tire spike systems are frequently employed but do not limit the momentum, drive, or control of a

vehicle to an extent that could be useful in any type of control or checkpoint scenario. Consequently, while tire spike systems are primarily used in high-speed pursuit applications, they are limited, in that they cripple the target just enough to allow law enforcement to force the vehicle to a stop.

Restraining nets are most comparable to electrical vehicle stoppers with respect to their intended application and desired effect. Restraining net systems and electrical vehicle stoppers both completely arrest vehicles, although by different means. Restraining nets bind the front axle of the vehicle, causing it to forcibly lose momentum and skid to a stop. Thus, the vehicle operator loses the ability to steer the vehicle, further resulting in a lower potential for collateral damage. Electrical systems stop the engine of the vehicle, leaving the operator with control for the duration of the vehicle's momentum. Physical barrier structures can then be employed to force an affected vehicle to stop in a fairly short distance. Modern vehicles lose power steering when the engine is cut off, such that the maneuverability of the vehicle is limited enough to

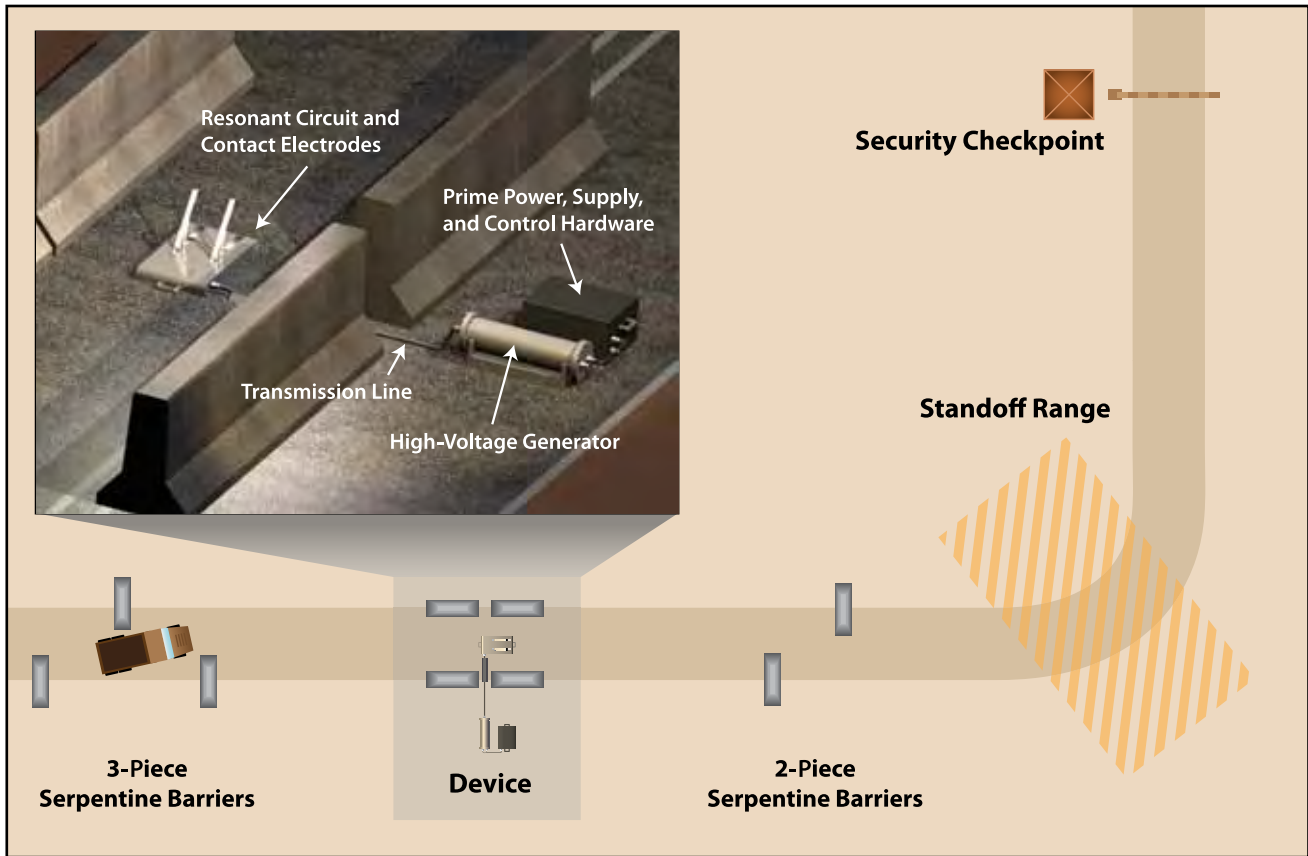

Figure 3. Conceptual Rendering of an Employed Electric Vehicle Stopping System

allow normally nonrestrictive serpentines to be effective at limiting roll-off distances.

One key logistical advantage of electrical vehicle stoppers, compared to restraining nets, is the average cost per engagement. Restraining net systems are one-time use devices that cost several thousand dollars each. Electrical systems initially cost tens of thousands of dollars but can perform thousands of stops within the expected lifetime of the device. Also, there is no requirement to physically reset or reload an electrical system, as with restraining nets. The maintenance required for electrical systems involves the occasional replacement of electrode arms and the inspection of the system connections and pressure levels.

Operationally, both systems have limitations on the types of targets that can be effectively stopped. Restraining nets are limited by vehicle momentum, which can be a product of high speeds or large vehicles. Electrical systems are not limited by vehicle size or speed, but they require additional support from structures—such as serpentines or speed bumps—to force the target to brake and dissipate its momentum once the engine has been stopped.

Both devices typically cause damage to targeted, stopped vehicles. Restraining nets almost always cause tire damage. Less commonly, brake lines, front axles, wheels, and transmissions also might be damaged. Electrical systems typically damage engine controllers, security modules, and

engine sensors. In addition, noncritical parts—such as gauges, radios, and cabin fans—also might be damaged. Moreover, moving affected targets is much less of an issue with electrical stoppers than vehicles stopped by net systems, which must first have the net cut away and freed before the target is moved to the side of the roadway.

SYSTEM REFINEMENT AND LOOK FORWARD

Previous attempts to field electrical vehicle-stopping systems have been hampered by limited success rates on a large population of vehicles. Many models of vehicles are easily affected by any type of large injected current, while others are fairly resistant. Through carefully designed and controlled experiments, and logistical regression modeling techniques, the DEWO team has been able to determine key waveform attributes that scale with stopping effectiveness rates on a representative population of vehicles. Successful stop rates exceeding 90 percent have been achieved on a diverse vehicle test set by engineering system resonators to enhance system performance. The DEWO team, through continued research, testing, and evaluation, is continuing its work to increase the reliability and effectiveness of these systems to make them more compact and to improve their functionality for future military and law enforcement applications.



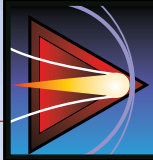

NONLETHAL SMALL-VESSEL STOPPING WITH HIGH-POWER MICROWAVE TECHNOLOGY

By Jacob Walker



The employment of small vessels to attack merchant ships and other seafaring units has emerged as a significant threat to international navigation and safe operations on the high seas. Along with swarm tactics, small vessels have been known to carry improvised explosive devices, help smuggle terrorists and weapons, and serve as attack platforms on the water for larger weapons. While kinetic solutions serve as the decisive option, alternative solutions that employ nonlethal means are being explored. A depiction of a swarm of small vessels ready to attack is shown in Figure 1.

The Naval Surface Warfare Center, Dahlgren Division's (NSWCDD's) Directed Energy Warfare Office (DEWO) is evaluating directed-energy (DE) concepts based on high-power microwave (HPM) technology for nonlethal vessel-stopping applications. Nonlethal weapons are defined by the Department of Defense (DoD) as weapons that are

explicitly designed and primarily employed so as to incapacitate personnel or materiel while minimizing fatalities, permanent injury to personnel, and undesired damage to property and the environment.¹

Several methodologies exist for using nonlethal means to stop small vessels. They include:

- Running-gear or prop entanglement systems
- Exhaust stack blockers
- A sea-anchor vessel-stopping system, which casts a net across the bow of a vessel to impart resistance
- Small-craft disablers, which insert a spear into the hull and deploy a fin that drags in the water, making steering impossible

Prop entanglement systems, exhaust stack blockers, and sea-anchor systems are useful and effective, but all are operationally difficult to deliver when deployment methods rely on positioning them in front of, or directly over, a vessel moving



Figure 1. Depiction of a Small-Vessel Swarm Ready to Attack

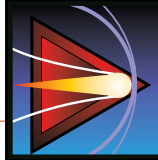

at high speeds. Small-craft disablers also are a formidable vessel-stopping solution and may be easier to deploy, but they cause permanent damage to the vessel in question.

Under the direction of the Joint Non-Lethal Weapons Directorate (JNLWD), the DEWO is in the initial stages of a multiyear effort to evaluate DE concepts for nonlethal vessel-stopping applications. It is currently focusing on HPM technology. This technology uses HPM sources to radiate radio frequency (RF) pulses downrange to interfere with motor-control electronics and significantly impede or stop small-vessel motors with minimal collateral damage. These RF pulses can be generated using different technologies ranging from wideband LC oscillators and microwave tubes (e.g., magnetrons, klystrons, and backward wave oscillators) to emerging solid-state technologies (e.g., nonlinear transmission line and photo-conductive switching). An outboard motor on a test stand is shown in Figure 2.

In comparison to kinetic weapons or other nonlethal systems, HPM avoids gross physical destruction to the vessel while, more importantly, providing zero-to-low risk of human injury. HPM accomplishes this at safe distances using speed of light delivery,

therefore making evasion difficult, if not impossible, with the added benefit of scalable effects ranging from disruption to damage. Despite its numerous advantages, the use of HPM technology as a nonlethal weapon presents challenges as well, including a trade-off between system size and standoff range. This is particularly important when considering the use of HPM systems in different environments.

Upfront HPM source development costs represent one of the biggest challenges. However, long-term savings associated with HPM technology can offset this challenge. For example, prop entanglement systems might be deployed only once before they are rendered useless. HPM sources integrated onto a ship or other military vehicle can be employed in potentially thousands of missions, therefore resulting in a lower cost per single use, bringing overall associated costs of the system down significantly. Priorities for HPM nonlethal weapons include developing a system effective against different types of small vessels.

NSWCDD's Directed Energy Division began HPM susceptibility testing to determine the effectiveness of HPM weapons against relevant outboard engines. This involves testing small vessels in



Figure 2. Outboard Motor Test Stand

a variety of environments, including reverberation and anechoic chambers, and open-air testing. All help identify different, effective waveform parameters such as frequency, pulse width, rise time, and required power or energy on target. They further facilitate the identification of design specifications necessary for an eventual HPM source. This source, once developed, will then be integrated into one of several potential platforms. Candidate concepts of deployment include U.S. Coast Guard and naval vessels in addition to unmanned surface or aerial vessels. Another potential application might be to supplement existing Coast Guard or Navy platforms used for fast-boat interdiction with an HPM vessel-stopping capability. A small-vessel test using an HPM source is shown in Figure 3.

Developing solutions for the growing threat that small vessels pose to navigation and safe operations in the world's oceans is one of JNLWD's top priorities. Using nonlethal HPM weapons to stop vessels will provide the warfighter with a viable option for swarm threat and fast-boat interdiction. DEWO is working diligently to accelerate this technology and provide a DE alternative to kinetic weapons and fulfill this long overdue capability gap.

REFERENCE

1. *Department of Defense Dictionary of Military and Associated Terms*, Joint Publication 1-02, 12 April 2001 (as amended through 19 August 2009).



Figure 3. Small-Vessel Testing Using a High-Power Microwave Source



Directed Energy



We look forward as we provide enterprise-wide technical and strategic leadership for the efficient and effective development, acquisition, and fielding of directed-energy systems for the warfighter.

Dale Sisson

Head, Electromagnetic and
Sensor Systems Department
NSWCDD, Dahlgren, Virginia



Fallen Warriors

Here we honor those who died while serving their country



NSWCDD/MP-09/34

Statement A: Approved for public release; distribution is unlimited