

Fundamentals of Die Casting Design

G. Bar–Meir, Ph. D.

1107 16th Ave S. E.

Minneapolis, MN 55414-2411

This book is licensed under Gnu Free document License or

Permission is granted to make and distribute verbatim copies of this book provided the copyright notice and this permission notice are preserved on all copies.

Permission is granted to process the document source code through T_EX or other formatters and print the results, and distribute the printed document, provided the printed document carries a copying permission notice identical to this one, including the references to where the source code can be found and the official home page.

Permission is granted to copy and distribute modified versions of this book under the conditions for verbatim copying, provided that the entire resulting derived work is distributed under the terms of a permission notice identical to this one.

Permission is granted to copy and distribute translations of this book into another language, under the above conditions for modified versions.

The author would appreciate a notification of modifications, translations, and printed versions. Thank you.

Preface

This book, Fundamental of Die Casting Design, describes the fundamental of design of the die casting process and die mold/runner. It is intended for people who have at least some knowledge of the basics of fundamental science, such as calculus, physics etc. This book will benefit the die casting engineer (the project and process engineers) as well as managers and anyone else who deals with the die casting operations will find this information useful.

The structure of this book is such that many of the chapters should be usable independently. For example, if you need information about, say, pQ² diagram, you can read just chapter 7. I hope this makes the book easier to use as a reference manual. However, this manuscript is first and foremost a text book, and secondly a reference manual only as a lucky coincidence.

I have tried to describe why the theories are the way they are, rather than just listing “seven easy steps” for each task. This means a lot of information is presented which is not necessary for everyone. These explanations have been marked as such and can be skipped.¹ Reading everything will, naturally, increase your understanding of the fundamentals of die casting design.

This work was done on a volunteer basis: I believe professionals working in the die casting design field will benefit from this information and that this is the best way to get the information out to all people in this profession. I also believe that information / “stories” of die casting design must be told. My experience has been that the “cartel” of “scientists”, and in general of the die casting establishment, have controlled what information is shared². Like all volunteer work, there is a limit to how much effort I have been able to put into book and its’ research. Most of my knowledge of die casting was developed in the Twin Cities and Tel–Aviv. It never has been funded. Hence, this knowledge has limits and more research is welcome. This book will be better when **good** research projects are funded and outstanding scientists (such as Prof.

¹At present, the book is not well organized and the marking will be in the next addition.

²As scientist, I feel this book should be dedicated only to die casting design and its issues only. I apologies for dealing with issues which are not science. I feel, however that if those driving the industry don’t change, the die casting industry will change dramatically. Check out your company: has it been sold? or is it bankrupt or in financial troubles?

Eckert of U. of M.) carry it out. Moreover, due to my poor English and time limitation, the explanations are not as good as if I had a few years to perfect them. As you read, you will notice I have not worked out all the details of the explanations/examples in some areas where my research and knowledge have not yet matured. At present, there is no satisfactory theory/model/knowledge in these areas³. I have left some issues which have unsatisfactory explanations/knowledge in the book, however marked with a question mark. I hope to write about these area in the future.

I have tried to make this text of the highest quality possible and am interested in your comments and ideas on how to make it better. Bad language, errors, ideas for new areas to cover, rewritten sections, more fundamental material, more mathematics (or less mathematics); I am interested in all. If you want to be involved in the editing, graphic design, or proofreading, please drop me a line. You may contact me via eMail at "genick@nadca.org".

Several people have helped me with this book, directly or indirectly. I would like to especially thank Prof. R.E.G. Eckert, whose work on dimensionless analysis study of die casting was the inspiration for this book. I would like to acknowledge that some of the material in this book was revised due to George Wilson of Sparta Light Metal, Inc.

The symbol META need to add typographical conventions for blurb here. This is mostly for the author's purposes and also for your amusement. There are also notes in the margin, but those are for the author's purposes only. They will be remove in the next edition.

I encourage anyone with a penchant for writing, editing, graphic ability, L^AT_EX knowledge, and a desire to carry out experiments to join me in improving this book. If you have Internet e-mail access, you can contact me at "genick@nadca.org".

³I have found either major mistakes or problems in the "common" models of these area or no research was done by scientists from other fields.

Would NADCA continue to sponsor erroneous research works?

NADCA, for all practical purposes, controls all the public funding in USA for die casting research. NADCA has supported the researchers who have produced work which violates basic physics laws such as Brevick from Ohio State University (research work about the critical shot sleeve velocity). I have informed NADCA about these research works years ago and to my great astonishment NADCA continues to support these researchers (for example, NADCA is still sponsoring Brevick's research on plunger velocity). Why?

This book lists some of researchers who produce erroneous or/and poor research work, such as Al Miller from Ohio State University, Nguyen from CSIRO and many others. Would NADCA continue support their research? You will be the judge.

Perhaps they will ask you, "How can everybody be wrong and only this newcomer be right?" Ask yourself the following questions and make your own conclusion: Do you know of anyone who knows how to correctly calculate any of the die casting process parameters, such as plunger diameter, gate area etc.? Even better, do you know anyone who know hows to calculate the actual profit (or loss) of their die casting production? Do you know of anyone who **really** uses calculations to get improved casting and is successful?

Consider this: Doehler Jarvis, up to two years ago, was very active in NADCA research. They participated in NADCA committees and also took an active role in the research done by NADCA supported researchers. **Guess what happened to the biggest die casting company in the world?**

Will I Be in Trouble?

Many people have said I will be in trouble because I am telling the truth. Those with a vested interest in the status quo (I hope you, the reader, know who they are) will try to use their power to destroy me. In response, I challenge my opponents to show that they are right. If they can do that, I will stand wherever they want and say that I am wrong and they are right. However, if they cannot prove their models and practices are based on solid scientific principles, nor find errors with my models (and I do not mean typos and English mistakes), then they should accept my results and help the die-casting industry prosper.

People have also suggested that I get life insurance and/or good lawyer because my opponents are very serious and mean business; the careers of several individuals are in jeopardy because of the truths I have exposed. If something does happen to me, then you, the reader, should punish them by supporting science and engineering and promoting the die-casting industry. By doing so, you prevent them from manipulating the industry and gaining additional wealth.

For the sake of my family, I have, in fact, taken out a life insurance policy. If something does happen to me, please send a thank you and work well done card to my family.

The conception of this Book

This book started as a series of articles to answer both specific questions that I have been asked, as well as questions that I was curious about myself. While addressing these questions, I realized that many commonly held "truths" about die-casting were scientifically incorrect. Because of the importance of these results, I have decided to make them available to the wider community of die-casting engineers. However, there is a powerful group of individuals who want to keep their monopoly over "knowledge" in the die-casting industry and to prevent the spread of this information.⁴ Because of this, I have decided that the best way to disseminate this information is to write a book. Please be advised that English is my weak point⁵. This book is my attempt to put this information, and more, in one place.

⁴Please read my correspondence with NADCA editor Paul Bralower and Steve Udvardy. Also, please read the references and my comments on pQ².

⁵I am looking for volunteer(s) to proofread this book

Volunteers

This chapter is dedicated to people who have volunteered to improve this book directly or indirectly. We, the whole the die casting industry, should be thankful to these individuals for their contributions to enhance the quality of this book and the knowledge of the die casting process design.

If you want to contribute to this work and to have your name printed here, please contact me.

Volunteers

John Joansson

Adeline Ong

Robert J. Fermin

Mary Fran Riley

Joy Branlund

Denise Pfeifer

How this book is organized

This book is divided into two parts. The first discusses the basic science required by a die-casting engineer; the second is dedicated to die-casting-specific science. The die-casting specific is divided into several chapters. Each chapter is divided into three sections: section 1 describes the “commonly” believed models; section 2 discusses why this model is wrong or unreasonable; and section 3 shows the correct, or better, way to do the calculations. I have made great efforts to show what existed before science “came” to die casting. I have done this to show the errors in previous models which make them invalid, and to “prove” the validity of science. I hope that, in the second edition, none of this will be needed since science will be accepted and will have gained validity in the die casting community. Please read about my battle to get the information out and how the establishment react to it.

Plea for L^AT_EX usage

Why the smart guys who control the publication in the die casting industry are using poor word processors? Is it only an accident that both the quality of the typesetting of papers in die casting congress and their technical content quality is so low? I believe there is a connection. All the major magazines of the the scientific world using T_EX or L^AT_EX, why? Because it is very easy to use and transfer (via the Internet) and, more importantly, because it produces high quality documents. NADCA continued to produce text on a low quality word processor. Look for yourself; every transaction is ugly.

Linux has liberated the world from the occupation and control of Microsoft OS. We hope to liberate the NADCA Transaction from such a poor quality word processor. T_EX and all (the good ones) supporting programs are free and available every where on the web. There is no reason not to do it. Please join me in improving NADCA's Transaction by supporting the use of L^AT_EX by NADCA.

Abstract

Die-casting engineers have to compete not only with other die-casting companies, but also against other industries such as plastics, and composite materials. Clearly, the "black art" approach, which has been an inseparable part of the engineer's tools, is in need of being replaced by a scientific approach. Excuses that "science has not and never will work" need to be replaced with "science does work". All technologies developed in recent years are described in a clear, simple manner in this book. All the errors of the old models and the violations of physical laws are shown. For example, the "common" pQ^2 diagram violates many physical laws, such as the first and second laws of thermodynamics. Furthermore, the "common" pQ^2 diagram produces trends that are the opposite of reality, which are described in this book.

The die casting engineer's job is to produce maximum profits for the company. In order to achieve this aim, the engineer must design high quality products at a minimum cost. Thus, understanding the economics of the die casting design and process are essential. These are described in mathematical form for the first time in this volume. Many new concepts and ideas are also introduced. For instance, how to minimize the scrap/cost due to the runner system, and what size of die casting machine is appropriate for a specific project.

The die-casting industry is undergoing a revolution, and this book is part of it. One reason (if one reason can describe the situation) companies such as Doehler Jorvis (the biggest die caster in the world) and Shelby are going bankrupt is that they do not know how to calculate and reduce their production costs. It is my hope that die-casters will turn such situations around by using the technologies presented in this book. I believe this is the only way to keep the die casting professionals and the industry itself, from being "left in the dust."



CONTENTS

I	BASIC SCIENCE	1
1	Introduction	3
1.1	The importance of reducing production costs	4
1.2	Designed/Undesigned Scrap/Cost	5
1.3	Linking the Production Cost to the Product Design	6
1.4	Historical Background	6
1.5	Numerical Simulations	8
1.6	“Integral” Models	11
1.7	Conclusion	12
2	Basic Fluid Mechanics	13
2.1	Introduction	13
2.2	What is fluid? Shear stress	14
2.2.1	Thermodynamics and mechanics concepts	14
	Thermodynamics	14
2.2.2	Control Volume, c.v.	15
2.2.3	Energy Equation	16
2.2.4	Momentum Equation	16
2.2.5	Compressible flow	16
3	Dimensional Analysis	17
3.1	Introduction	20
3.2	The processes in die casting	21
3.2.1	Filling the shot sleeve	21
3.2.2	Shot sleeve	22
3.2.3	Runner system	24
3.2.4	Die cavity	26
3.2.5	Intensification period and after	27

3.3	Special topics	28
3.3.1	Is the flow in die casting is turbulent?	28
	Additional note on numerical simulation	30
3.3.2	Dissipation effect on the temperature rise	30
3.3.3	Gravity effects	31
3.4	Estimates of the time scales in die casting	31
3.4.1	Utilizing semi dimensional analysis for characteristic time	31
	Miller's approach	33
	Present approach	34
3.4.2	The ratios of various time scales	36
3.5	Similarity applied to Die cavity	37
3.5.1	Governing equations	37
3.5.2	Design of Experiments	40
3.6	Summary of dimensionless numbers	40
3.7	Summary	42
3.8	Questions	42
4	Fundamentals of Pipe Flow	47
4.1	Introduction	47
4.2	Universality of the loss coefficients	47
4.3	A simple flow in a straight conduit	49
4.3.1	Examples of the calculations	50
4.4	Typical Components in the Runner and Vent Systems	51
4.4.1	bend	51
4.4.2	Y connection	52
4.4.3	Expansion/Contraction	52
4.5	Putting it all to Together	52
4.5.1	Series Connection	52
4.5.2	Parallel Connection	53
5	Flow in Open Channels	55
5.1	Introduction	55
5.2	Typical diagrams	58
5.3	Hydraulic Jump	58
II	DIE CASTING DESIGN	59
6	Runner Design	61
6.1	Introduction	61
6.1.1	Backward Design	61
6.1.2	Connecting runner segments	62
6.1.3	Resistance	63

CONTENTS

7	pQ² Diagram Calculations	67
7.1	Introduction	68
7.2	The “common” pQ ² diagram	68
7.3	The validity of the “common” diagram	74
7.3.1	Is the “common” model valid?	74
7.3.2	Are the trends reasonable?	76
	Plunger area/diameter variation	76
	Gate area variation	77
7.3.3	Variations of the Gate area, A_3	78
7.4	The reformed pQ ² diagram	79
7.4.1	The reform model	79
7.4.2	Examining the solution	81
	The gate area effects	81
	General conclusions from example 7.4.2	85
	The die casting machine characteristic effects	86
	Plunger area/diameter effects	89
	Machine size effect	93
	Precondition effect (wave formation)	94
7.4.3	Poor design effects	94
7.4.4	Transient effects	94
7.5	Design Process	94
7.6	The Intensification Consideration	95
7.7	Summary	96
7.8	Questions	96
8	Critical Slow Plunger Velocity	97
8.1	Introduction	98
8.2	The “common” models	98
8.2.1	Garber’s model	98
8.2.2	Brevick’s Model	101
	The square shot sleeve	101
8.2.3	Brevick’s circular model	102
8.2.4	Miller’s square model	102
8.3	The validity of the “common” models	103
8.3.1	Garber’s model	103
8.3.2	Brevick’s models	103
	square model	103
	Improved Garber’s model	103
8.3.3	Miller’s model	103
8.3.4	EKK’s model (numerical model)	104
8.4	The Reformed Model	104
8.4.1	The reformed model	104
8.4.2	Design process	106
8.5	Summary	107
8.6	Questions	107

9 Venting System Design	109
9.1 Introduction	109
9.2 The "common" models	110
9.2.1 Early (etc.) model	110
9.2.2 Miller's model	111
9.3 General Discussion	112
9.4 The Analysis	113
9.5 Results and Discussion	115
9.6 Summary	118
9.7 Questions	118
10 Clamping Force Calculations	119
III MORE INFO: Appendixes	121
A What The Establishment's Scientists Say	123
A.1 Summary of Referee positions	124
A.2 Referee 1 (from hand written notes)	125
A.3 Referee 2	126
A.4 Referee 3	129
B My Relationship with Die Casting Establishment	135
C Density change effects	151
D Fanno Flow	155
D.1 Introdcion	156
E Reference	159

Part I

BASIC SCIENCE

CHAPTER 1

Introduction

In the recent years many die casting companies have gone bankrupt (Doehler–Jarvis and Shelby to name a few) and many other die casting companies have been sold (St. Paul Metalcraft, Tool Products, OMC etc.). What is/are the reason/s for this situation? Some blame poor management. Others blame bad customers (which is mostly the automobile industry). Perhaps there is something to these claims. Nevertheless one can see that the underlying reasons is the missing knowledge of how to calculate the when profits are made and how to design so that costs will be minimized. To demonstrate how the absurd situation is the fact that there is not even one company today that can calculate the actual price of any product that they are producing. Moreover, if a company is able to produce a specific product, no one in that company looks at the redesign (mold or process) in order to reduce the cost systematically. If there is a company which does such A thing, the author will be more then glad to learn about it.

In order to compete with other industries, the die casting industry **must** reduce cost as much as possible (20% to 40%) and lead time significantly (by 1/2 or more). To achieve these goals, the engineer must learn to connect mold design to the cost of production (charged to the customer) and to use the correct scientific principals involved in the die casting process to reduce/eliminate the guess work. This book is part of the revolution in die casting by which science is replacing the black art of design. For the first time, a link between the cost and the design is spelled out. Many new concepts, based on scientific principles, are introduced. The old models, which plagued by the die casting industry for many decades, are analyzed, their errors are explained and the old models are superseded.

“Science is good, but it is not useful in the floor of our plant!!” George Reed, the former president of SDCE, recently announced in a meeting in the local chapter (16) of NADCA. He does not believe that there is A relationship between “science” and what he does with the die casting machine. He said that because he does not follow NADCA recommendations, he achieves good castings. For instance, he stated that in the conventional recommendation in order to increase the gate velocity, plunger diameter needs to be decreased. He said that

because he does not follow this recommendation, and/or others, that is the reason he succeeds in obtaining good castings. He is right and wrong. He is right not to follow the conventional recommendations since they violate many basic scientific principles. One should expect that models violating scientific principles would produce unrealistic results. When such results occur, this should actually strengthen the idea that science has validity. The fact that models which appear in books today are violating scientific principals and therefore do not work should actually convince him, and others, that science does have validity. Mr. Reed is right (in certain ranges) to increase the diameter in order to increase the gate velocity as will be covered in Chapter 7.

The above example is but one of many of models that are errant and in need of correction. To date, the author has not found so much as a single "commonly" used model that has been correct in its conclusions, trends, and/or assumptions. The wrong models/methods that have plagued the industry are: 1) critical slow plunger velocity, 2) pQ^2 diagram, 3) plunger diameter calculations, 4) runner system design, 5) vent system design, etc¹. These incorrect models are the reasons that "science" does not work. The models presented in this book are here for the purpose of answering the questions of design in a scientific manner which will result in reduced costs and increased product quality.

Once the reasons to why "science" did not work are clear, one should learn the correct models for improving quality, reducing lead time and reducing production cost. The main underlying reason people are in the die casting business is to make money. One has to use science to examine what the components of production cost/scrap are and how to minimize or eliminate each of them to increase profitability. The underlying purpose of this book it to help the die caster to achieve this target.

1.1 The importance of reducing production costs

Contrary to popular belief, a reduction of a few percentage points of the production cost/scrap does not translate into the same percentage of increase in profits. The increase is a more complicated function. To study the relationship further see Figure 1.1 where profits are plotted as a function of the scrap. A linear function describes the relationship when the secondary operations are neglected. The maximum loss occurs when all the material turned out to be scrap and it is referred to as the "investment cost". On the other hand maximum profits occur when all the material becomes products (no scrap of any kind). The breakeven point (BEP) has to exist somewhere between these two extremes. Typically, for the die casting industry, the breakeven point lies within the range of 65%–75% product (or 25%-35% scrap). Typical profits in the die casting industry are about 20%.²

$$\text{relative change in profits\%} = \left(\frac{\text{new product percent} - \text{BEP}}{\text{old product percent} - \text{BEP}} - 1 \right) \times 100 \quad (1.1)$$

Example 1.1

¹The author would like to find/learn about even about a single model presently used in the industry that is correct in any area of the process modeling (understanding).

²If it below 15% the author would expect the owner to consider to invest in the stock exchange. There is a possibility to make more profits this way. Perhaps this is the reason that so many die casting companies sold in these days.

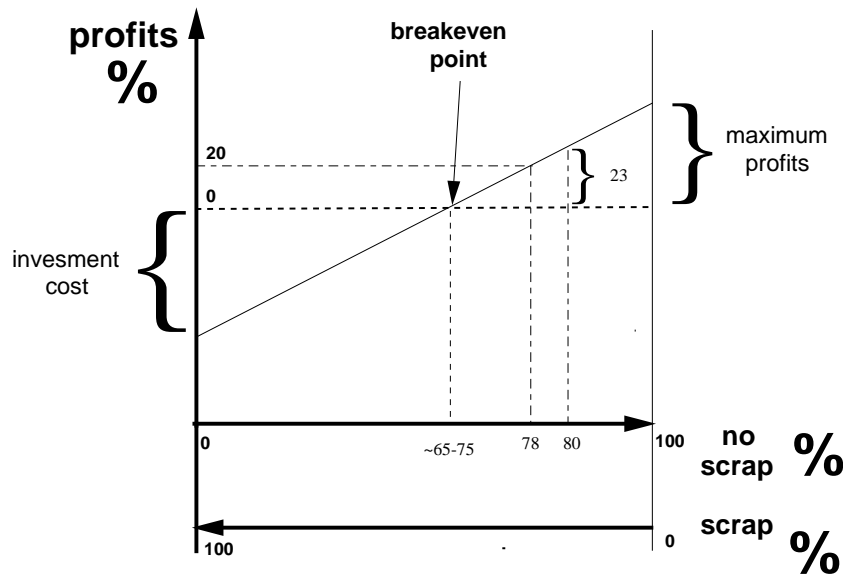

Figure 1.1: The profits as a function of the amount of the scrap

what would be the effect on the profits of a small change (2%) in a amount of scrap for a job with 22% scrap (78% product) and with breakeven point of 65%?

Solution

$$\left(\frac{80 - 65}{78 - 65} - 1 \right) \times 100 = 15.3\%$$

a reduction of 2% in a amount of the scrap to be 20% (80% product) results in increase of more then 15.3% in the profits.

This is a very substantial difference. Therefore a much bigger reduction in scrap will result in much, much bigger profits.

to put figure about this point (relative profits)

1.2 Designed/Undesigned Scrap/Cost

There are many definitions of scrap. The best definition suited to the die casting industry should be defined as all the metal that did not turn-out to be a product. There are two kinds of scrap/cost: 1) those that can be eliminated, and 2) those that can only be minimized. The first kind is referred to here as the undesigned scrap, and the second is referred as designed scrap. What is the difference? It is desired not to have rejection of any part (the rejection should be zero) and, of course it is not designed and this is the undesigned scrap/cost. However, it is impossible to eliminate the runner completely, and it is desirable to minimize its size in such a way that the cost will be minimized. This is minimization of cost and this is the designed

scrap/cost. The die casting engineer must distinguish between these two scrap components in order to be able to determine what should be done and what cannot be done.

Science can make a significant difference; for example, it is possible to calculate the critical slow plunger velocity and thereby eliminating (almost) air entrainment in the shot sleeve in order to minimize the air porosity. This means that air porosity will be reduced and marginal products (even poor products in some cases) are converted into good quality products. In this way, the undesigned scrap is eliminated. This topic will be studied further in Chapter ??.

Two different examples of designed scrap/cost and undesigned scrap/cost have been presented. There is also the possibility that a parameter which reduces the designed scrap/cost will, at the same time, reduce the undesigned scrap/cost. An example of such a parameter is the venting system design. It can easily be shown that there is a critical design below which air/gas is exhausted easily and above which air is trapped. In the latter case, the air/gas pressure builds up and results in a poor casting (large amount of porosity)³. The analysis of the vent system demonstrates that a design much above the critical design and design just above the critical design yielding has almost the same results, – small amount of air entrainment. One can design the vent just above the critical design so the design scrap/cost is reduced to a minimum amount possible. Now both targets have been achieved: less rejections (undesigned scrap) and less vent system volume (designed scrap).

1.3 Linking the Production Cost to the Product Design

It is sound accounting practice to tie the cost of every aspect of production to the cost to be charged to the customer. Unfortunately, the practice today is such that the price of the products are determined by some kind of average based on the part weight plus geometry and not on the actual design and production costs. Furthermore, this idea is also perpetuated by researchers who do not have any design factor (El-Mehalawi, Liu and Miller1997). Here it is advocated to price according to the actual design and production costs. It is believed that better pricing results from such a practice. In today's practice, even after the project is finished, no one calculates the actual cost of production, let alone calculating the actual profits. The consequences of such a practice are clear: it results in no push for better design, and with no idea which jobs make profits and which do not. Furthermore, considerable financial cost is incurred which could easily be eliminated. Several chapters in this book are dedicated to linking the design to the cost (end-price).

1.4 Historical Background

Die casting is relatively speaking a very forgiving process, in which after tinkering with the several variables one can obtain a medium quality casting. For this reason there has not been any real push toward doing good research. Hence, all the major advances in the understanding of the die casting process were not sponsored by any of the die casting institutes/associations. Many of the people in important positions in the die casting industry suffer from what is known as the "Detroit attitude" which is very difficult to change. *"We are making a lot of money so*

³The meaning of the critical design and above and below critical design will be discussed in Chapter 9

Section 1.4. Historical Background

why change?" . Moreover, the controlling personnel on the research funds believe that the die casting is a metallurgical manufacturing process and therefore the research has to be carried out by either Metallurgical Engineers or Industrial Engineers. Furthermore, this come as no surprise – that people-in-charge of the research funding fund their own research. One cannot wonder if there is a relationship between so many erroneous models which have been produced and the personnel controlling the research funding. A highlight of the major points of the progress of the understanding is described herein.

The vent system design requirements were studied by some researchers, for example Suchs, Veinik, and Draper and others. These models, however, are unrealistic and do not provide a realistic picture of the real requirements or of the physical situation since they ignore the major point, the air compressibility. Yet, they provide a beginning in moving the die casting process towards being a real science.

One of the secrets of the black art of design was that there is a range of gate velocity which creates good castings depending on the alloy properties being casted. The existence of a minimum velocity hints that a significant change in the liquid metal flow pattern occurs. Veinik (Veinik1962) linked the gate velocity to the flow pattern (atomization) and provide a qualitative physical explanation for this occurrence. Experimental work (Maier1974) showed that liquid metals, like other liquids, flow in three main patterns: a continuous flow jet, a coarse particle jet, and an atomized particle jet. Other researchers utilized the water analogy method to study flow inside the cavity for example, (Bochvar et al.1946). At present, the (minimum) required gate velocity is supported by experimental evidence which is related to the flow patterns. However, the numerical value is unknown because the experiments were poorly conducted for example, (Stuhrke and Wallace1966) the differential equations that have been "solved" are not typical to die casting⁴.

In the late 70's an Australian group (Davis1975) suggested adopting the pQ^2 diagram for die casting in order to calculate the gate velocity, the gate area and other parameters. As with all the previous models they missed the major points of the calculations. As will be shown in Chapter 7, the Australian's model produce incorrect results and predict trends opposite to reality. This model took root in die casting industry for the last 25 years. Yet, one can only wonder why this well established method (supply and demand theory) which was introduced into fluid mechanics in the early of this century reached the die casting only in the late seventies and was then erroneously implemented.

Until the 1980 there was no model that assisted the understanding air entrapment in the shot sleeve. Garber described the hydraulic jump in the shot sleeve and called it the "wave", probably because he was not familiar with this research area. He also developed erroneous model which took root in the industry in spite of the fact that **it never works**. One can only wonder why the major die casting institutes/associations have not published this fact. Moreover, NADCA and other institutes continue to funnel large sums of money to the researchers (for example, Brevick from Ohio State) who used Garber's model even after they knew that Garber's model is totally wrong.

The turning point of the understanding was when Prof. Eckert, the father of modern heat transfer, introduced the dimensional analysis applied to the die casting process. This established a scientific approach which provided a uniform schemata for uniting experimental work with the

⁴Read about this in Chapter 3.

actual situations in the die casting process. Dimensional analysis demonstrates that the fluid mechanics processes, such as filling of the cavity with liquid metal and evacuation/extraction of the air from the mold, can be dealt when the heat transfer is assumed to be negligible. However, the fluid mechanics has to be taken into account in the calculations of the heat transfer process (the solidification process).

This proved an excellent opportunity for “simple” models to predict the many parameters in the die casting process, which will be discussed more fully in this book. Here two examples of new ideas that mushroomed in the inspiration of prof. Eckert’s work. It has been shown that (Bar-Meir1995b) the net effect of the reactions is negligible.⁵ The development of the critical vent area concept provided the major guidance for 1) the designs to the venting system 2) when the vacuum system needs to be used. In this book, many of the new concepts and models, such as economy of the runner design, plunger diameter calculations, minimum runner design, etc are described for the first time.

1.5 Numerical Simulations

Numerical simulations have been found to be very useful in many areas which lead many researchers attempting to implement them into die casting process. Considerable research work has been carried out on the problem of solidification including fluid flow which is known also as Stefan problems (Hu and Argyropoulos1996). Minaie et al in one of the pioneered work (Minaie, Stelson and Voller1991) use this knowledge and simulated the filling and the solidification of the cavity using finite difference method. Hu et al (Hu et al.1992) used the finite element method to improve the grid problem and to account for atomization of the liquid metal. The atomization model in the last model was based on the mass transfer coefficient. Clearly, this model is in waiting to be replaced by a realistic model to describe the mass transfer⁶. The Enthalpy method was further exploded by Swaminathan and Voller (Swaminathan and Voller1993) and others to study the filling and solidification problem.

While numerical simulation looks very promising, all the methods (finite difference, finite elements, or boundary elements etc) ⁷ suffer from several major drawbacks that prevent from them yielding reasonable results.

- There is no theory (model) that explains the heat transfer between the mold walls and the liquid metal. The lubricant sprayed on the mold change the characteristic of the heat transfer. The difference in the density between the liquid phase and solid phase creates a gap during the solidification process between the mold and the ingate which depends on the geometry. For example, Osborne et al (Osborne et al.1993) showed that a commercial software (MAGMA) required fiddling with the heat transfer coefficient to get the numerical simulation match the experimental results⁸.
- As it was mentioned earlier, it is not clear when the liquid metal flows as a spray and

⁵Contradictory to what was believed at that stage.

⁶One finds that it is the easiest to critic one own work or where he was involved.

⁷Commercial or academic versions.

⁸Actually, they tried to prove that the software is working very well.

Section 1.5. Numerical Simulations

when it flows as continuous liquid. Experimental work has demonstrated that the flow, for large part of the filling time, is atomized (Bar-Meir1995a).

- The pressure in the mold cavity in all the commercial codes are calculated without taking into account the resistance to the air flow out. Thus, built-up pressure in the cavity is poorly estimated and therefore the characteristic flow of the liquid metal in the mold cavity is poorly estimated as well.
- The flow in all the simulations is assumed to be turbulent flow. However, time and space are required to achieved a fully turbulent flow. For example, if the flow at the entrance to a pipe with the typical conditions in die casting is laminar (actually it is a plug flow) it will take a runner with a length of about 10[m] to achieved fully developed flow. With this in mind, clearly some part of the flow is laminar. Additionally, the solidification process is faster compared to the dissipation process in the initial stage so it is also a factor in changing the flow from a turbulent (in case the flow is turbulent) to a laminar flow.
- The liquid metal velocity at the entrance to the runner is assumed in the numerical simulation and not calculated. In reality this velocity has to be calculated utilizing pQ^2 diagram.
- If turbulence is exist in the flow field, what is the model that describes it adequately? Clearly, model such $k - \epsilon$ are based on isentropic homogeneous with mild change in the properties cannot describes situations where the flow changes into two-phase flow (solid-liquid flow) etc.
- The heat extracted from the die is done by cooling liquid (oil or water). In most models (all the commercial models) the mechanism is assumed to be by "regular cooling". In actuality, some part of the heat is removed by boiling heat transfer.
- The governing equations in all the numerical models, I am aware of, neglecting the dissipation term in during the solidification. The dissipation term is the most import term in that case.

One wonders how, with unknown flow pattern (or correct flow pattern), unrealistic pressure in the mold, wrong heat removal mechanism (cooling method), erroneous governing equation in the solidification phase, and inappropriate heat transfer coefficient, a simulation could produce any realistic results. Clearly, much work is need to be done in these areas before any realistic results should be expected from any numerical simulation. Furthermore, to demonstrate this point, there are numerical studies that assume that the flow is turbulent, continuous, no air exist (or no air leaving the cavity) and proves with their experiments that their model simulate "reality" (Kim and Sant1995). On the other hand, other numerical studies assumed that the flow does not have any effect on the solidification and of course have their experiments to back this claim (Davey and Bounds1997). Clearly, this contradiction suggest several options:

- Both of the them are right and the model itself does not matter.
- One is right and the other one is wrong.
- Both of them are wrong.

The third research we mentioned here is an example where the calculations can be shown to be totally wrong and yet the researchers have experimental proofs to back them up. Viswanathan et al (Viswanathan et al.1997) studied a noble process in which the liquid metal is poured into the cavity and direct pressure is applied to the cavity. In their calculations the authors assumed that metal enter to the cavity and fill the whole entrance (gate) to the cavity. Based on this assumption their model predict defects in certain geometry. Now lets look at this model a bit more in critical examination. The assumption of no air flow out by the authors (was “explained” to me privately that air amount is small and therefore not important) is very critical as will be shown here. The volumetric air flow rate into the cavity has to be on average equal to liquid metal flow rate (conservation of volume for constant density). Hence, air velocity has to be approximately infinite to achieve zero vent area. Conversely, if the assumption that the air flows in same velocity as the liquid entering the cavity, liquid metal flow area is a half what is assume in the researchers model. In realty, the flow of the liquid metal is in the two phase region and in this case it is like turning a bottle full of water over and liquid inside flows as “blobs”⁹. In this case the whole calculations do not have much to do with reality since the velocity is not continuous and different from the calculated.

Another example of such study is the model of the flow in the shot sleeve by Backer and Sant from EKK (Backer and Sant1997). The researchers assumed that the flow is turbulent and they justified it because they calculated an found a “jet” with extreme velocity. Unfortunately, all the experimental evidence demonstrate that there is no such jet (Madsen and Svendsen1983). It seems that this jet is results from the “poor” boundary and initial conditions¹⁰. In the presentation, the researchers also stated that results they obtained for laminar and turbulent flow were the same¹¹ while a simple analysis can demonstrate the difference is very large. Also, one can wonder how liquid with zero velocity to be turbulent. With these results one can wonder if the code is of any value or the implementation is at fault.

The bizarre belief that the numerical simulations are a panacea to the all the design problem is very popular in the die casting industry. I am convinced that any model has to describes the physical situation in order to be useful. I cannot see experimental evidence supporting wrong models as a real evidence¹². I would like to see numerical calculations that produce realistic results based on the real physics understanding. Until that point come, I will suggest to be suspicious about any numerical model and its supporting evidence.¹³

⁹Try it your self! fill a bottle and turn it upside and see what happens.

¹⁰The boundary and initial conditions were not spelled out in the paper!! However they were implicitly stated in the presentation.

¹¹So why to use the complicate turbulent model?

¹²Clearly some wrong must be there. For example, see the paper by Murray and colleague in which they use the fact that two unknown companies were using their model to claim that it is correct.

¹³With all this harsh words, I would like to take the opportunity for the record, I do think that work by Davey’s group is a good one. They have inserted more physics (for example the boiling heat transfer) into their models which I hope in the future lead us to have realistic numerical models.

1.6 "Integral" Models

Unfortunately, the numerical simulations of the liquid metal flow and solidification do not yield reasonable results at the present time. This problem has left the die casting engineers with the usage of the "integral approach" method. The most important tool in this approach is the pQ^2 diagram, one of the manifestations of supply and demand theory. In this diagram, an engineer insures that die casting machine ability can fulfill the die mold design requirements; the liquid metal is injected at the right velocity range and the filling time is small enough to prevent premature freezing. One can, with the help of the pQ^2 diagram, and by utilizing experimental values for desired filling time and gate velocities improve the quality of the casting. The gate velocity has to be above certain value to assure atomization and below a critical value to prevent erosion of the mold. This two values are experimental and no reliable theory is available today known to the author (Bar-Meir1995a). The correct model for the pQ^2 diagram has been developed and will be discussed in Chapter 7. A by-product of the above model is the plunger diameter calculations and it is discussed in Chapter 7.

It turns out that many of the design parameters in die casting have a critical point above which good castings are produced and below which poor castings are produced. Furthermore, much above and just above the critical point do not change much but costs much more. This is where the economical concepts plays a significant role. Using these concepts, one can increase the probably significantly and, obtain very quality casting and reduce the leading time. Additionally, the main cost components (machine cost and other) are analyzed and have to be taken into considerations when one chooses to design the process with will be discussed in the Chapter ?? on the economy of the die casting.

Porosity can be divided into two main categories; shrinkage porosity and gas/air entrainment. The porosity due to entrapped gases constitutes a large part of the total porosity. The creation of gas/air entrainment can be attributed to at least four categories: lubricant evaporation (and reaction processes¹⁴), vent locations (last place to be filled), mixing processes, and vent/gate area. The effects of lubricant evaporation have been found to be insignificant. The vent location(s) can be considered partially solved since only qualitative explanation exist. The mixing mechanisms are divided into two zones: the mold, and the shot sleeve. Some mixing processes have been investigated and can be considered solved. The requirement on the vent/gate areas is discussed in Chapter 9. When the mixing processes are very significant in the mold other methods are used and they include: evacuating the cavities (vacuum venting), Pore Free Technique (in zinc and aluminum casting) and squeeze casting. The first two techniques are used to extract the gases/air from the shot sleeve and die cavity before the gases have the opportunity to mix with the liquid metal. The squeeze casting is used to increase the capillary forces and, therefore, to minimize the mixing processes. All these solutions are cumbersome and more expensive and should be avoided if possible.

The mixing processes in the runners, where the liquid metal flows vertically against gravity in a relative large conduit, are considered to be insignificant¹⁵. The enhanced air entrainment in the shot sleeve is attributed to operational conditions for which a blockage of the gate by

¹⁴Some researchers view the chemical reactions (e.g. release of nitrogen during solidification process) as category by itself.

¹⁵Some work has been carried out and hopefully will be published soon.

a liquid metal wave occurs before the air is exhausted. Consequently, the residual air is forced to be mixed into the liquid metal in the shot sleeve. Now with Bar-Meir's formula one can calculate the correct critical slow plunger velocity and this will be discussed in Chapter 8.

1.7 Conclusion

It is an exciting time in the die casting industry because for the first time an engineer can start using real science in the designing the runner/mold and the die casting process. Many models have been corrected and many new techniques have been added. It is the new revolution in the die casting industry.

CHAPTER 2

Basic Fluid Mechanics

2.1 Introduction

My experience shows that many engineers/researchers in die casting are lacking the understanding of the basic fluid mechanics. This is my attempt to introduce this fundamental aspect of science to the die casting community. As someone who grew most of his life around people who are experts in this area, I feel strongly that this knowledge cannot be avoided. The design of the process as well as the properties of casting (especially magnesium alloys) are determined by the fluid mechanics/heat transfer processes. I hope that others will join me to spread this knowledge.

There are numerous books about introductory fluid mechanics¹. I would suggest to readers who want to expand their knowledge to read the book "Fluid Mechanics" by A.G. Hansen, 1967. I found this book to provide a clear illustrative picture of the physics. This chapter is a kind of summary of that book. I add only the most fundamental aspects of the topic known as two phase flow.² I hope that you will find this interesting and you will further continue to read books which are dealing with fluid mechanics.

First we will introduce the nature of fluids and basic concepts from thermodynamics. Later we deal with the integral analyses which will be divided into introduction of the control volume concept and continuity equations. The energy equation will be explained in the next section. Later we will be discussing the momentum equation. Lastly, the chapter will be dealing with the flow of compressible gases. We refrain from dealing with too many topics such as boundary layers, non-viscous flow, machinery flow etc because we believe that they are not essential to understand the rest of this book. Nevertheless, they are important and it is advisable that the reader will

¹I grew on Streeter's and Shames' books, I feel that they are examples of too much material for readers as introductory text books.

²The knowledge on that topic came from Tel-Aviv University. The department of Fluid Mechanics and Heat Transfer where I obtained my M.Sc. That department has a concentration of world-famous experts in this area such as Dr. Y. Taïte, and others. Many of the figures and discussions are borrowed from there.

read on these topics as well.

2.2 What is fluid? Shear stress

Fluid in this book is considered as a substance that “moves” continuously when exposed to a shear stress. The liquid metals are an example of such substance. However, the liquid metals do not have to be in the liquidous phase to be considered liquid. Aluminum at approximately 400°C is continuously deformed when shear stress are applied. The whole semi-solid die casting area deals with materials that “looks” solid but behaves as liquid.

Consider a liquid that resting on the bottom and the top is moving in a velocity, U (see Figure ??). The force required for this operation is proportional to

$$F \propto \frac{UA}{h} \quad (2.1)$$

Or in other words, the shear stress is proportional to

$$\tau \propto \frac{U}{h} \quad (2.2)$$

Under steady state condition and a linear velocity distribution it can be shown that $dU/dy = U/h$ and therefore

$$\tau \propto \frac{dU}{dy} = \mu \frac{dU}{dy} \quad (2.3)$$

This assumption leads as to the Newtonian fluid. In this book we only mentioned the fact that there are fluids that do exhibit non-Newtonian behavior and they are not discussed in this book.

The viscosity is property of liquid and it was found that the ratio of the viscosity to the density is important. This ratio is called kinematic viscosity, and denoted as ν . For liquid metal this property is function of the temperature and sensitive to the pressure.³

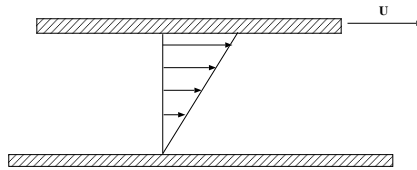

Figure 2.1: A schematic of shear flow

2.2.1 Thermodynamics and mechanics concepts

Thermodynamics

We adopt the concepts of system and control volume. The system is a collection of particles. The particles do not leave the system. The control volume is arbitrary selection of boundaries.

³Here we need a volunteer to explain in more details the properties of liquid metals

Section 2.2. What is fluid? Shear stress

Particls can leave the system and boundaries can move. These two concepts will used extensivley through the book. The first law applied to the non accelarting system can be written as

depend on the coordinate, dis-
cussion?

$$\left(\begin{matrix} \text{original energy} \\ \text{within a sys-} \\ \text{tem} \end{matrix} \right) + \left(\begin{matrix} \text{energy} & \text{re-} \\ \text{cieved by} & \text{the} \\ \text{system} \end{matrix} \right) = \left(\begin{matrix} \text{final energy in} \\ \text{the system} \end{matrix} \right) + \left(\begin{matrix} \text{energy trans-} \\ \text{ferred from} \\ \text{the system} \end{matrix} \right) \quad (2.4)$$

The mathematical representation of equaition 2.4 is given by

$$\frac{V_1^2}{2} + gz_1 + u_1 + q = \frac{V_2^2}{2} + gz_2 + u_2 + w \quad (2.5)$$

Note that it is a very good approximation to assume that the mass is a constant for system. The pressure and the hydrostatic pressure discusion with example vintrury pump

The Newton law of motion to
take from scriven with the in-
tegration

2.2.2 Control Volume, c.v.

The control volume was introduced by L. Euler⁴ In the control volume, c.v we are looking at spesific volume which mass can enter and leave. The simplest c.v. is when the boundry are fixed and it is refered to as the *Non-deformable* c.v.. The conservation of mass to such system can be very good approximated by

$$\frac{d}{dt} \int_{V_{c.v.}} \rho dV = - \int_{S_{c.v.}} \rho V_{rn} dA \quad (2.6)$$

This equation states the change in the volume come from the difference of masses being added through the boundary.

put two examples of simple for mass conservation.

For deformable c.v.

$$\frac{d}{dt} \int_{V_{c.v.}} \rho dV = \int_{V_{c.v.}} \frac{d\rho}{dt} dV + \int_{S_{c.v.}} \rho V_{rn} dA \quad (2.7)$$

Example 2.1

Emptying a tank

put picture of the tank throw empty process

A tank as shown in the picture emptys from the exit. write the mass conservation equations that discribe the physical situation

Solution

The continuity equation 2.7

put another example

⁴a blind man known as the master of calculus, made his living by being a tutor, can you imagine he had eleven kids: where he had the time and energy to develop all the great things he has done.

2.2.3 Energy Equation

Find the time that it will take to empty the tank given in previous example.

2.2.4 Momentum Equation

The second Newton law of motion is written mathematically as

$$\Sigma F = \frac{D}{Dt} mV \quad (2.8)$$

This expression, of course, for fluid particles can be written as

$$\Sigma F = \frac{D}{Dt} \int_{V_{sys}} V \rho dV \quad (2.9)$$

or in more explicitly it can be written as

$$\Sigma F = \frac{d}{dt} \int_{V_{c.v.}} \rho V dV + \int_{A_{c.v.}} \rho V \cdot V_{rn} dA \quad (2.10)$$

2.2.5 Compressible flow

My experience teaching this material is that take more than semester to good student to have good understanding of this complex material. Yet to give very minimal information is seems to me essential to the understanding of the venting design. I made a great effort to discuss the physics with minimum mathematical details. I found Shapiro's book to be excellent source for those who want to know in greater details this material. I will appreciate comments from the readers on how to present this complex issue without boring the reader with extra mathematical/physics stuff.

CHAPTER 3

Dimensional Analysis

*The shear, S , at the ingate is determined by the average velocity, U , of the liquid and by the ingate thickness, t . Dimensional analysis shows that is directly proportional to (U/t) . The constant of proportionality is difficult to determine, ...**

Murray, CSIRO Australia

Contents

3.1	Introduction	20
3.2	The processes in die casting	21
3.2.1	Filling the shot sleeve	21
3.2.2	Shot sleeve	22
3.2.3	Runner system	24
3.2.4	Die cavity	26
3.2.5	Intensification period and after	27
3.3	Special topics	28
3.3.1	Is the flow in die casting is turbulent?	28
	Additional note on numerical simulation	30
3.3.2	Dissipation effect on the temperature rise	30

*This was taken from "The Design of feed systems for thin walled zinc high pressure die castings", Metallurgical and materials transactions B Vol. 27B, February 1996, pp. 115–118. This is an excellent example of poor research. Here, I will change this book approach and I will not discuss specific mistakes which are numerous. I would like only to point out how dimensional analysis can take "cluttered" paper such as this one and turn it into a real valuable. This example will appear in next addition of this book in a form of question to the student. Bytheway, the authors mentioned that in Australia their idea is working. Is the physics laws are really different over there? As the proof to their model, the researchers mentioned two unknown companies as fact that their model is working. What a nice proof! Of course, the problem in the company was exactly as described in the model and solution requires to use the model.

3.3.3 Gravity effects	31
3.4 Estimates of the time scales in die casting	31
3.4.1 Utilizing semi dimensional analysis for characteristic time . . .	31
Miller's approach	33
Present approach	34
3.4.2 The ratios of various time scales	36
3.5 Similarity applied to Die cavity	37
3.5.1 Governing equations	37
3.5.2 Design of Experiments	40
3.6 Summary of dimensionless numbers	40
3.7 Summary	42
3.8 Questions	42

One of the important tools to understand and to design in the die casting process is dimensional analysis. Fifty years ago this method transformed the fluid mechanics/heat transfer into an “uniform” understanding. In this book I am attempting to introduce to the die casting field this established method¹. Experimental studies will be “expended/generalized” as it was done in convective heat transfer. It is hoped that as a result, separate sections for aluminum, zinc and magnesium will not exist in anymore die casting conferences. This chapter is based partially on Dr. Eckert’s book, notes and article on dimensional analysis applied to die casting. Several conclusions are derived from this analysis and they will be presented throughout this chapter. This chapter is intent for a reader who want to know why the formulation in the book is in the dimensionless form. It also can bring a great benefit to researchers who want to built their research on a solid foundation. For those who are dealing with the numerical research/calculation, it can be useful to learn when some parameters should be taken into account and why. Considerable amount of physical explanation is provided in this Chapter.

In dimensional analysis, the number of the effecting parameters is reduced to a minimum by replacing the dimensional parameters by dimensionless parameters. Some researchers point out that the chief advantages of this analysis are “to obtain experimental results with a minimum amount of labor, results in a form having maximum utility” (Hansen1967, pp. 395). The dimensional analysis has several other advantages which include 1)increase of understanding, 2) knowing what is important, and 3)compacting the presentation².

should we include a discussion about advantages of the compact of presentation

Dimensionless parameters are parameters that represent a ratio that do not have a physical dimension. In this chapter only things related to die casting are presented. The experimental study assists to solved problem when the solution of the governing equation can not be solved. To achieve this, we design experiments that are “similar” to the situation that we simulating. This method is called the similarity theory in which the governing differential equations needed to solve are defined and design experiments with the same governing differential equations. This does not necessarily means that we have to conduct experiments exactly as they were in reality. An example how the similarity is applied to the die cavity is given in the section 3.5. Casting in general and die casting in particular, I am not aware of experiments that utilize this method. For example, after the Russians (Bochvar et al.1946) introduced the water analogy method (in casting) in the 40’s all the experiments (known to the author such by Wallace’s group, CSIRO etc) conducted poorly design experiments. For example, experimental study of Gravity Tiled Die Casting (low pressure die casting) performed by Nguyen’s group in 1986 comparing two parameters Re and We . The flow is “like” free falling for which the velocity is a function of the height ($U \sim \sqrt{gH}$). Hence, the equation $Re_{model} = Re_{actual}$ should lead only to $H_{dodel} \equiv H_{actual}$ and not to any function of U_{model}/U_{actual} . The value of U_{model}/U_{actual} is actually constant for constant for height ratio. Many other important parameters which controlling the governing equations are not simulated (Nguyen and Carrig1986). The governing equations in that case include several other important parameters which have not been controlled, monitored and simulated³. Moreover, the Re number is controlled by the flow rate and the characteristics

¹Actually, Prof. E.R.G. Eckert introduced the dimensional analysis to the die casting long before me. I am only his zealous disciple, all the credit should go to him. Of course, all the mistakes are mine and none of Dr. Eckert’s. All the typos in Eckert’s paper were my responsibility (there are many typos) for which I apologize.

²The importance of compact presentation I attribute to Prof. M. Bentwitch who was my mentor during my master studies.

³Besides many conceptual physical mistakes, the authors have a conceptual mathematical mistake. They

of the ladle opening and not as in the pressurized pipe flow as the authors assumed.

3.1 Introduction

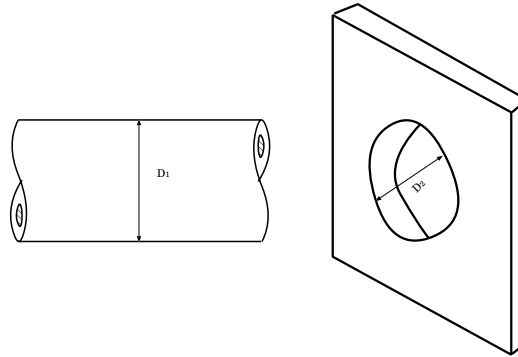

Figure 3.1: Rode in to the hole example

Lets take a trivial example of fitting a rode into a circular hole (see Figure 3.1). To have solve this problem, it is required to know two parameters; one the diameter of the rode and second the diameter of the hole. Actually it is required to have the only one parameter, the ratio of the rode diameter to the hole diameter. The ratio is a dimensionless number and with this number one can say that for a ratio larger than one, the rode will not enter the hole; and ratio smaller than one rode is too small. Only when the ratio is equal to one the rode is said to be fitting. This allows one to draw the situation by using only one coordinate. Furthermore, if one wants to deal with tolerances, the dimensional analysis can easily be extended to say that when the ratio is equal from 0.99 to 1.0 the rode is fitting, and etc. When one will use the two diameters description he will need more than this simple sentence to describe it.

In preceding simplistic example the advantages are minimal. In many real problems, including the die casting process, this approach can remove cluttered views and put the problem in a focus. It also helps to use information from different problems to a 'similar" situation. Throughout the book the reader will notice that the systems/equations are converted to a dimensionless form to augment the understanding.

tried to achieve the same Re and Fr numbers in the experiments as in reality for low pressure die casting. They derived equation for the velocity ratio based on equal Re numbers (model and actual). They have done the same for Fr numbers. Then they equate the velocity ratio based on equal Re to velocity ratio based on equal Fr numbers. However velocity ratio based on equal Re is a constant and does vary with the tunnel dimension (as opposed to distance from the starting point.). The fact that these ratios have the same symbols does not mean that they are really the same. These two ratios are different and cannot be equated.

3.2 The processes in die casting

The die casting process can be broken to many separated processes which are controlled by different parameters. The simplest division of the process for a cold chamber is as the following: 1) filling the shot sleeve, 2) slow plunger velocity, 3) filling the runner system 4) filling the cavity and overflows, and 5) solidification process (also referred as intensification process). This division to such subprocesses results in a clear picture on each process. On the one hand, in processes 1 to 3, we would like to have a minimum heat transfer/solidification to take place for the obvious reason. On the other hand, in the rest of the processes, the solidification is the major concern.

In die casting, the information/conditions down-stream do not travel upstream. For example, the turbulence does not travel from some point at the cavity to the runner and of course to the shot sleeve. This kind of relationship is customarily denoted as a parabolic process (because in mathematics the differential equations describes this kind of cases called parabolic). To large extent it is true in die casting. The pressure in the cavity does not effect the flow in the sleeve or the runner when vent system are well designed. In other words, the design of the pQ^2 diagram is not controlled by down-stream conditions. Another example, the critical slow plunger velocity is not affected by the air/gas flow/pressure in the cavity. In general, the turbulence generated down-stream does not travel up-stream in this process. One has to restrict this characterization to some points. One particularly has to be mentioned here: the poor design of the vent system effects the pressure in the cavity and therefore effects does travel down stream. For example, the pQ^2 diagram calculations are affected by poor vent system design.

3.2.1 Filling the shot sleeve

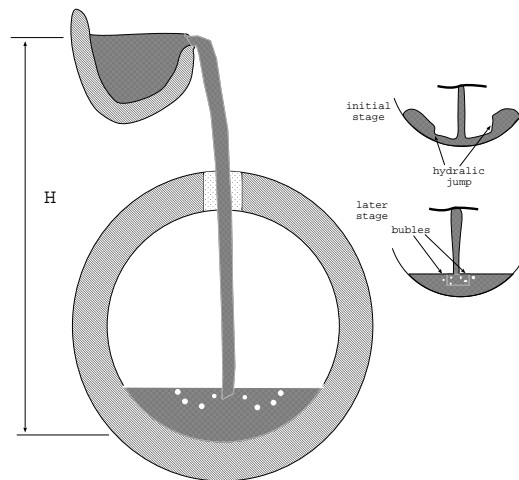

Figure 3.2: Filling of the shot sleeve

The flow from the ladle to the shot sleeve did not receive much attention in the die casting

research⁴ because it is believed that it does not play a significant role. For low pressure die casting, the flow of liquid metal from the ladle through “channel/s” to the die cavity plays an important role⁵. The importance of the understanding of this process can show us how to minimize the heat transfer, layer created on the sleeve (solidification layer), and sleeve protection [a) erosion b) plunger problem].

perhaps more explanations depend on the readers responses

insert the calculations for the time scale for hydraulic jump creation

put estimate on when hydraulic jump disappear.

At first the hydraulic jump is created when the liquid metal enters the sleeve. As the liquid metal level in the sleeve rises, the location of the jump moves closer to the impinging center. At certain point, the jump disappears due to the liquid depth level (the critical depth level). At this stage, air bubbles are entrained in the liquid metal which augment the heat transfer. At present, we have an extremely limited knowledge about the heat transfer during process and of course less about minimization of it.

The heat transfer from the liquid metal to the surroundings is affected by the velocity and the flow patterns since the mechanism of heat transfer is changed from a like natural convection to a like force convection. In addition the liquid metal jet surface is also effected by heat transfer to some degree by change in the properties. As first approximation the radius of the jet changes due to the velocity change. For a laminar flow the velocity goes as $\sim \sqrt{x}$ where x is the distance from the ladle. For a constant flow rate assumption the radius will change as $r \sim 1/\sqrt[4]{x}$. Note that this relationship is not valid vary near the ladle proximity ($r/x \sim 0$ (why?)). The heat transfer increases as a function of x for these two reasons.

to make graph for the estimated h and velocity in that case

a plug flow. why?

A good assumption? show change of density effect?

The heat transfer to the sleeve in the impinging area is the most significant and at present only very limited knowledge is available due complexity.

3.2.2 Shot sleeve

discuss the fluid mechanics during the quieting time. Dissipation problems during solidification. Residual flow in the sleeve and effects on the critical plunger velocity. What is optimum quieting minimum heat transfer and maximum removal of residual flow. open problem!

In this section we examine the solidification effects. One of the assumptions in the analysis of the critical slow plunger velocity was that the solidification process does not play important role (see Figure 3.3). The typical time for heat to penetrate a typical layer in air/gas phase is in order of minutes. Moreover, the density of the air/gas is 3 order magnitude smaller than the liquid metal. Hence, most of the resistance to heat transfer is in the gas phase.

Meta Additionally, it has been shown that the liquid metal surface is continuously replaced by slabs of material below the surface which is known in the scientific literature as the renewal surface theory.

End

Therefore, if we look at the heat transfer from the liquid metal surface to the air as shown in Figure 3.3 (mark as process 1) the air acts as insulator to the liquid metal. The solidified layer thickness can be approximated by looking at the case of a plate with temperature below melting point of the liquid metal when the liquid metal initial temperature is constant and above the freezing point (above the mushy zone and $\frac{t}{R} \ll 1$).

to show the calculations of natural convection between hot surface and air above

perhaps to put form Osizic's paper derivations on pipes to show minimum error? circumference

⁴I have found only very few of papers dealing with this aspect. If you know about research concerning this issue or you would like to work on this topic, please drop me a line.

⁵I have made some elementary estimates of fluid mechanics and heat transfer and I am waiting to finish it and to find a journal without the kind of referees mentioned in Appendix A. Or perhaps it will appear in the

Section 3.2. The processes in die casting

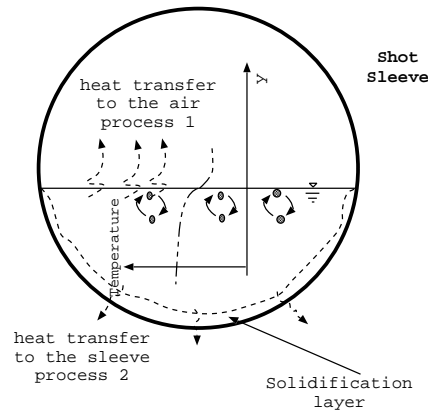

Figure 3.3: Heat transfer processes in the shot sleeve

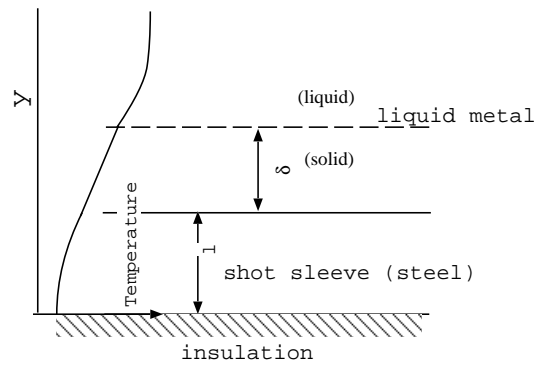

Figure 3.4: Solidification of the shot sleeve time estimates

The governing equation in the sleeve is

$$\rho_d c_{p_d} \frac{\partial T}{\partial t} = k_d \left(\frac{\partial^2 T}{\partial y^2} \right) \quad (3.1)$$

where the subscript d denote the properties should be taken for the sleeve material.

Boundary condition between the sleeve and the air/gas is

$$\left. \frac{\partial T}{\partial n} \right|_{y=0} = 0 \quad (3.2)$$

next addition of this book. If you would like to help me to finish the work on this problem, please drop me a line.

Where n represent the perpendicular direction to the die. Boundary conditions between the liquid metal (solid) and sleeve

$$k_{steel} \left(\frac{\partial T}{\partial y} \right) \Big|_{y=l} = k_{AL} \left(\frac{\partial T}{\partial y} \right) \Big|_{y=l} \quad (3.3)$$

The governing equation for the liquid metal (solid phase)

$$\rho_{lm} c_{p_{lm}} \frac{\partial T}{\partial t} = k_{lm} \left(\frac{\partial^2 T}{\partial y^2} \right) \quad (3.4)$$

where lm denote that the properties should be taken for the liquid metal. We also neglect the dissipation and the velocity due to the change of density and natural convection.

Boundary condition between the phases of the liquid metal is given by

$$v_s \rho_s h_{sf} = k_l \left(\frac{\partial T}{\partial y} \right) \Big|_{y=l+\delta} - k_s \left(\frac{\partial T}{\partial y} \right) \Big|_{y=l+\delta} \sim k \frac{\partial(T_l - T_s)}{\partial y} \Big|_{y=l+\delta} \quad (3.5)$$

- h_{sf} the heat of solidification
- ρ_s liquid metal density at the solid phase
- v_n velocity of the liquid/solid interface
- k conductivity

The governing equation in the liquid phase with neglecting of the natural convection and density change is

$$\rho_l c_{p_l} \frac{\partial T}{\partial t} = k_l \frac{\partial^2 T}{\partial y^2} \quad (3.6)$$

The dissipation function can be assumed to be negligible in this case.

There are three different periods in the heat transfer 1) filling the shot sleeve 2) during the quieting time, and 3) during the plunger movement. In the first period heat transfer is relatively very large (major solidification). At present we don't know much about the fluid mechanics not to say much about the solidification process/heat transfer. The second period can be simplified and analyzed as if we know more the initial velocity profile. A simplified assumption can be made considering the fact that Pr number is very small (large thermal boundary layer compared to fluid mechanics boundary layer). Additionally, it can be assumed that the natural convection effects are marginal. In the last period, the heat transfer is composed from two zones: one) behind the jump and two) ahead of the jump. The heat transfer ahead of the jump is the same as in the second period while the heat transfer behind the jump is like heat transfer in to a plug flow for low Pr number. The heat transfer in such cases have been studied in the past. The reader can refer to, for example, the book "Heat and Mass Transfer" by Eckert and Drake.

3.2.3 Runner system

The flow in the runner system has to be divided into sections 1) flow with free surface 2) filling the cavity when the flow is pressurized (see Figures 3.5 and 3.6). In the first section the

continue with Goodman's derivations perhaps to put a short discussion about the Φ application to this case.

Perhaps modified Goodman's method (the integral method) can be applied.

to check what it is in the new version and put the exact ref put the typical solution, or just the ref

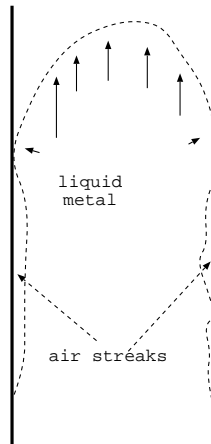

Figure 3.5: Entrance of liquid metal to the runner

gravity affects the air entrainment. A dominate parameter in this case is We number. This phenomenon determines how much metal has to be flushed out. It is well known that the liquid interface cannot be a straight line. Above certain velocity (typical to die casting, high Re number) air leaves streaks of air/gas slabs behind as shown in Figure 3.5. These streaks create a low heat transfer zone at the head of the “jet” and “increases” its velocity. The air entrainment created in this case supposed to be flushed out through the vent system in a proper process design. Unfortunately, at present we know very little about this issue especially as concerned with geometry typical to die casting.

should we insert the proof to this point, no jump in the pressure in the interface?

to insert the calculation of the Fr . We numbers to scales of forces

Meta In the second phase, the flow in the runner system is pressurized and the typical runner length is in order of 0.1[m]. In that case, if we have a large velocity let say 10[m/sec]. The velocity due to gravity is ≈ 2.5 [m/sec]. The Fr number assumes the value $\sim 10^2$ for which gravity play a limited role.

End

The converging nozzle such as the transition into runner system (what a good die casting engineer should design) tents to reduce the turbulence and can even eliminate it. In that view, the liquid metal enters the runner system (almost) as a laminar flow (actually close to a plug flow). For a duct with a typical dimension of 10 [mm] and a mean velocity, $U = 10$ [m/sec], (during the second stage), for aluminum die casting, the Reynolds number is:

$$Re = \frac{Ub}{\nu} \approx 5 \times 10^{-7}$$

which is a supercritical flow. However, the flow is probably laminar flow due to the short time.

Meta Another look at turbulence: The boundary layer is a function of the time (during the filling period) is of order

$$\delta = 12\nu t$$

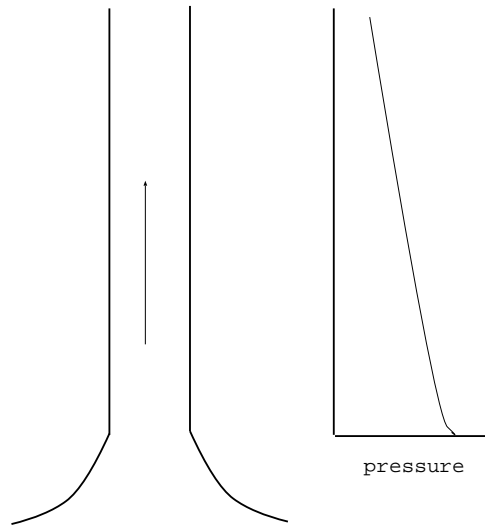

Figure 3.6: Flow in runner when during pressurizing process

The boundary layer in this case can be estimated as⁶ for time of the first phase. Anyhow, the utilizing the time of 0.01[sec] the viscosity of aluminum the boundary layer is of the thickness of 0.25[mm] which indicate that flow is laminar.

End

Meta To include dimensional analysis of this aspect? Similar to Streeter presentation with additional discussion about branching in instantaneous starting flow. Flow switching to turbulence pattern by poor design increase resistance in the middle of the filling process in one branch with the poor design. Branching in runner system is discussed in chapter 4

End

3.2.4 Die cavity

All the numerical simulation of die filling are done almost exclusively assuming that the flow is turbulent and continuous (no two phase flow). In the section 3.3.1 a discussion about the existence of turbulence and what kind of model is appropriate or not are presented. The liquid metal enters the cavity as a non-continuous flow. Actually, it is preferred that the flow will be atomized (spray). While that there is considerable literature about many geometries non available to typical die casting configurations⁷. The flow can be atomized as either in a laminar or turbulent region. The experiments by the author and by others showed that the flow turns into spray in many cases (See Figures 3.7).

insert the ref about the paper about atomization, the experiments about critical entrance velocity

⁶only during the flow in the runner system, no filling of the cavity

⁷I just wonder who were the opposition to this research? perhaps one of the referees as in the Appendix A for the all clues I have received.

Section 3.2. The processes in die casting

In the section 3.4.1 it will be shown that the time for atomization is very fast compared with any other process (filling time scale and, of course, the conduction heat transfer or solidification time scales). Atomization requires to have two streams with a significant velocity difference. Numerous experimental studies had shown that castings obtained when the injected velocity is above certain value are superior. This fact alone is enough to convince us that the preferred flow pattern is a spray flow. Yet, very small number of numerical models exist and used for die casting assuming spray flow (for example the paper by Hu et al (Hu et al.1992).). Experimental work commonly cited as a "proof" of turbulence was conducted in the mid 60's (Stuhrke and Wallace1966) utilizing water analogy⁸. The "white" spats they observed in their experiments are atomization of the water. Because these experiments were poorly conducted (no similarity to die casting process) the observation/information from these studies is very limited. Yet with this limitation in mind, one can conclude that the spray flow does exist.

Experiments Fondse et al (Fondse, Jeijdens and Ooms1983) show that atomization is larger in a laminar flow compared to a turbulent flow in a certain range. This fact further confusing what is the critical velocity needed in die casting. Since the experiments which measure the critical velocity were poorly conducted no reliable information is available on what is the flow pattern and what is the critical velocity⁹.

put the full references

3.2.5 Intensification period and after

The main concern in this phase is to extract heat from the die and to solidify the liquid metal as aptly as possible. The main resistance to the heat flow is in the die and the cooling liquid (oil or water based solution) . The heat transfered to the cooling liquid is via boiling mechanism in some part of the process. However, the characteristic boiling heat transfer time to achieve a steady state is larger than the whole process occurs and the typical equations (steady state) for the preferred situation (heat transfer only in the first mode) are not accurate. Thus, when we have very limited understanding of so many aspects of the process clearly, the effects of each process on other processes is also cluttered.

put reference to the english group
put boiling graph of Q vr. ΔT and to discuss the different mechanisms for steady state and when.

Meta the relationship between the pressure, density, and temperature. Insert the derivations about the void creation in sharp corners during solidification. Insert the other papers about the experiments about this issue.

End

⁸The problems in these experiments were, among other things, the dimensional numbers not simulated such as Re , Geometry etc. and therefore different differential equations not typical to die casting were "solved". The researchers also look at what is known as a "poor design" in which disturbances to flow downstream (this is like putting screen in the flow). However, a good design requires smooth contours.

⁹Beside other problems such as different flow velocity in different gates which never really measured, the pressure in the cavity and quality of the liquid metal entering the cavity (is it in two phase?) never been recorded.

3.3 Special topics

3.3.1 Is the flow in die casting is turbulent?

Transition from laminar to turbulent

It commonly assumed that the flow is turbulent in the shot sleeve, runner system, and the duration of the filling of the cavity. Further, it also assumed that the $k-\epsilon$ model can reasonably represent the turbulence structure. These assumptions are examined herein. We examine the flow in 1) the shot sleeve, 2) the runner system, and 3) the mold cavity. Note, that even if the turbulence is exist in some regions it doesn't necessarily mean that all the flow field is turbulent.

Figure 3.8 exhibits the transition to a turbulent flow for instantaneous starting flow in a circular pipe. The abscissa represents time and the y-axis represents the Re number at which transition to turbulence occurs. The points on the graphs show the transition to a turbulence. This figure demonstrates that a large time is required to turn the flow pattern to a turbulent which measured in several seconds. The figure demonstrates that the transition does not occur below a certain critical Re number (known as the critical Re number for steady state). It also shows that a considerable time has to elapse before transition to turbulence occurs even for a relatively large Reynolds number. The geometry in die casting however is different and therefore it is expected that the transition occurs at different times. Our present knowledge of this area is very limited. Yet, a similar transition delay is expected to occur after the "instantaneous" start-up which probably will be measured in seconds. The flow in die casting in many situations is very short (in order of milliseconds) and therefore it is expected that the transition to a turbulent flow does not occur. After the liquid metal is poured, it is normally repose for sometime in a range of 10's seconds. This fact is known in the scientific literature as the quieting time for which the existed turbulence (if exist) is reduced and after enough time (measured in seconds) is illuminated. Hence, if turbulence was created during the filling process of the shot sleeve is "disappeared". Now we can examine the question, is the flow in the duration of the slow plunger velocity is turbulent (see Figure 3.9).

Clearly, the flow in the substrate (a head the wave) is still (almost zero velocity) and therefore the turbulence does not exist. The Re number behind the wave is above the critical Re number (which is in the range of 2000–3000). The typical time for the wave to travel to the end of the shot sleeve are in the range of a $\sim 10^0$ second. At present there are no experiments on the flow behind the wave¹⁰. The estimation can be done by looking at what is known in the literature about the transition to turbulence in instantaneous starting pipe flow. It has been shown (Wyganski and Champan1973) that the flow changes from a laminar flow to turbulent flow occurs in an abrupt manner for a flow with supercritical Re number. A typical velocity of the propagating front (transition between laminar to turbulent) is about at same velocity as the mean velocity of the flow. Hence, it is reasonable to assume that the turbulence is confined to a small zone in the wave front since the wave is traveling in a faster velocity than the mean velocity. Note that the thickness of the transition layer is a monotone increase function of time (traveling distance). The Re number in the shot sleeve based on the diameter is in a range of $\sim 10^4$ which means that the boundary layer has not developed much. Therefore, the flow can

To discuss the free interface as oppose to solid interface.

should we insert a graph about the relation between the mean velocity and wave velocity in the shot sleeve

¹⁰It has to be said that similar situations are found in two phases flow but they different by the fact the flow in two phase flow is a sinusoidal in some respects.

Section 3.3. Special topics

be assumed as almost a plug flow with the exception of the front region.

what about the solid layer the skimmed to "increase" the plunger head and effects on the flow.

A note on numerical simulations

The most common model for turbulence that used in the die casting industry for simulating the flow in cavity is $k-\epsilon$. This model is based on several assumptions

1. isentropic homogeneous turbulence,
2. constant material properties (or a mild change of the properties),
3. continuous medium (only liquid (or gas), no mixing of the gas, liquid and solid what so ever), and
4. the dissipation does not play a significant role (transition to laminar flow).

The $k-\epsilon$ model is considered reasonable for the cases where these assumptions are not far from reality. It has been shown, and should be expected, that in cases where assumptions are far from reality, the $k-\epsilon$ model produces erroneous results. Clearly, if we cannot determine whether the flow is turbulent and in what zone, the assumption of isentropic homogeneous turbulence is very questionable. Furthermore, if the change to turbulence just occurred, one cannot expect the turbulence to have sufficient time to become isentropic homogeneous. As if this is not enough complication, we have to consider the effects of change of properties as results temperature change. Large changes in the properties such as viscosity have been observed in many alloys especially in the mushy zone.

While the assumption of the continuous medium is a semi reasonable in the shot sleeve and runner, it is far from reality in the die cavity. As discussed previously, the flow is atomized and it is expected to have a large fraction of the air in the liquid metal and conversely some liquid metal drops in the air/gas phase. In such cases, the isentropic homogeneous assumption is very dubious.

For these reasons the assumption of $k-\epsilon$ model seems unreasonable unless good experiments can show that the choice of the turbulence model does not matter for the calculation.

Meta To discuss the effect of the solidification on $k-\epsilon$ model. Different properties in different zones due to large thermal boundary layer.

End

Meta If we know close to nothing regarding what particles size we would preferred to have, how we cannot design the process and the gate.

End

Meta The question whether the flow in die cavity is turbulent or laminar is secondary. Since the two phase flow effects have to be considered such atomization, air/gas entrainment etc.

End

Additional note on numerical simulation

The solution of momentum equation for certain situations may lead to unstable solution. Such case is the two jets with deferent velocity flow into a medium and they are adjoint (see Figure 3.10). The solution of such flow can show that the velocity field can obtain unstable solution for which the flow moderately change to became like wave flow. However, in many cases this flow is turnout to be full with vortexes and such. The reason that this happened is the introduction of instabilities. Numerical calculations intrinsically are introducing instabilities because truncation of the calculations. In many cases, these truncations results over–shooting or under–shooting of the nature instability. In cases where the flow is unstable, a careful study is required to make sure that the solution did not produce an unrealistic solution in which larger or smaller than reality introduced instabilities. An excellent example of such a poor understating is a work made in EKK company (Backer and Sant1997). In that work, the flow in the shot sleeve was analyzed. The nature of the flow is two dimensional which can be seem by all the photos taken by numerous people (staring from the 50's). The presenter of that work explained that they have used 3D calculations because they want to study additionally the instabilities perpendicular to the flow direction. The numerical “instability” in this case are larger than real instabilities and therefore, the numerical results shows phenomena not exist in reality.

Reverse transition from turbulent flow to laminar flow

After the filling the die cavity, during the solidification process and intensification, the attained turbulence (if exist) is reduced and probably eliminated, i.e. the flow is laminar in a large portion of the solidification process. At present we don't comprehend when the transition point/criteria occurs and we must resort to experiments. It is a hope that some real good experiments using the similarity technique, outline in this book, will be performed. So more knowledge can be gained and hopefully will appear in this book.

3.3.2 Dissipation effect on the temperature rise

The large velocities of the liquid metal (particularly at the runner) theoretically can increase the liquid metal temperature. To study this phenomenon lets look at the case where all the kinetic energy is transformed into thermal energy.

$$\frac{U^2}{2} = c_p \Delta T \tag{3.7}$$

This equation leads to the definition of Eckert number

$$Ec = \frac{U^2}{c_p \Delta T} \tag{3.8}$$

When *Ec* number is very large it means that the dissipation plays a significant role and conversely when *Ec* number is small the dissipation effects are minimal.

Meta The effect of temperature on the properties of the liquid metal are considerable in the range of the mushy zone.

End

$\alpha = 2.310^{-7}$

Discuss the characteristic of the value to be inserted into equation 3.8. Put a footnote about squeeze casting.

to put the explanation about the temperature difference only regular die casting

continue the discussion here about the squeeze casting? where small change in the temperature create large change in the material properties. And calculate the *Br* number and discuss the significance

3.3.3 Gravity effects

The gravity has a large effect only when gravity force is large relatively to other forces. A typical velocity ranges generated by the gravity is the same as for a object falling in air. The air effects can be neglected since the air density is very small compared with the liquid metal density. The momentum is the other dominate force in the filling the cavity. Thus, the ratio of the momentum forces to the gravity force, also known as Froude number, determines if the gravity effects are important. The Froude number is defined here as

$$Fr = \frac{U^2}{\ell g} \quad (3.9)$$

Where U is the velocity, ℓ is the characteristic length g is the gravity force. For example, the characteristic pouring length is in order of 0.1[m], in extreme cases the velocity can reach 1.6[m] with characteristic time of 0.1[sec]. The author is not aware of experiments to verify the flow pattern in such cases (low Pr number due to solidification effect)¹¹. Yet, it is reasonable to assume that the liquid metal in such a case is laminar even though the Re number is relatively large ($\sim 10^4$) because of the short time and the short distance. The Re number is defined by the flow rate and the thickness of the exiting typical dimension. Note, the velocity reach its maximum value just before impinging on the sleeve surface.

The gravity has dominate effect on the flow in the shot sleeve since the typical value of the Froude number in that case (especially during the slow plunger velocity period) are in the range of 1. Clearly, any analysis of the flow has to take the gravity into consideration (see Chapter 8).

3.4 Estimates of the time scales in die casting

3.4.1 Utilizing semi dimensional analysis for characteristic time

The characteristic time scales determine the complexity of the problem. For example, if the time for heat transfer/solidification process in the die cavity is much larger than the filling time than the problem can broken into three separate cases 1)the fluid mechanics, the filling process, and 2)the heat transfer and solidification 3) dissipation (maybe considered with solidification). Conversely, the real problem in die filling is that we would like to the heat transfer process to be slower than the filling process to ensure a proper filling. The same can be said about other processes.

filling time

The characteristic time for filling a die cavity is determined by

$$t_f \sim \frac{L}{U} \quad (3.10)$$

¹¹I would like to learn about such experiments. Please drop me a line if you know.

Where L denotes the characteristic length of the die and U denotes the average filling velocity, determined by the pQ^2 diagram, in most practical cases this time typically is in order of 5–100 [millisecond]. Note, this time is not the actual filling time but related to it.

Atomization time

The characteristic time for atomization for a low Re number (large viscosity) is given by

$$t_{a_{viscosity}} = \frac{\nu \ell}{\sigma} \quad (3.11)$$

where ν is the kinematic viscosity, σ is the surface tension, and ℓ is the thickness of the gate. The characteristic time for atomization for large Re number is given by

$$t_{a_{momentum}} = \frac{\rho \ell^2 U}{\sigma} \quad (3.12)$$

The results obtained from these equations are different and the actual atomization time in die casting has to be between these two values.

Conduction time (die mold)

The governing equation the heat transfer for die reads

$$\rho_d c_{p_d} \frac{\partial T_d}{\partial t} = k_d \left(\frac{\partial^2 T_d}{\partial x^2} + \frac{\partial^2 T_d}{\partial y^2} + \frac{\partial^2 T_d}{\partial z^2} \right) \quad (3.13)$$

To obtain the characteristic time we dimensionlessed the governing equation and present it with a group of constants that determine value of the characteristic time by set it to unity. Lets define

$$t'_d = \frac{t}{t_{c_d}}; \quad x'_d = \frac{x}{\tilde{L}}; \quad y'_d = \frac{y}{\tilde{L}}; \quad z'_d = \frac{z}{\tilde{L}}; \quad \theta_d = \frac{T - T_B}{T_M - T_B} \quad (3.14)$$

\tilde{L} the characteristic path of the heat transfer from the die inner surface to the cooling channels

subscript

B boiling temperature of cooling liquid

M liquid metal melting temperature

With these definitions equation (3.13) is transformed to

$$\frac{\partial \theta_d}{\partial t} = \frac{t_{c_d} \alpha_d}{\tilde{L}^2} \left(\frac{\partial^2 \theta_d}{\partial x'^2} + \frac{\partial^2 \theta_d}{\partial y'^2} + \frac{\partial^2 \theta_d}{\partial z'^2} \right) \quad (3.15)$$

which leads into estimate of the characteristic time as

$$t_{c_d} \sim \frac{\tilde{L}^2}{\alpha_d} \quad (3.16)$$

Note the characteristic time is not effected by the definition of the θ_d .

discussion about the typical \tilde{L} estimates and how to calculate it

Conduction time in the liquid metal (solid)

The governing heat equation in the solid phase of the liquid metal is the same as equation (3.13) with changing properties to liquid metal solid phase. The characteristic time for conduction is derived similarly as done previously by introducing the dimensional parameters

$$t' = \frac{t}{t_{c_s}}; \quad x' = \frac{x}{\ell}; \quad y' = \frac{y}{\ell}; \quad z' = \frac{z}{\ell}; \quad \theta_s = \frac{T - T_B}{T_M - T_B} \quad (3.17)$$

where t_{c_s} is the characteristic time for conduction process and, ℓ , denotes the main path of the heat conduction process die cavity. With these definitions, similarly as was done before the characteristic time is given by

$$t_{c_s} \sim \frac{\ell^2}{\alpha_s} \quad (3.18)$$

Note again that α_s has to be taken for properties of the liquid metal in the solid phase. Also note that the solidified length, ℓ , changes during the process and discussing the case where whole die is solidified is not of the interest. Initially the thickness, $\ell = 0$ (or very small). The characteristic time for very thin layers is very small, $t_{c_s} \sim 0$. As the solidified layer increases the characteristic time increase. However, the temperature profile is almost established (if other processes where to remain in the same conditions). Similar situation can be found in a semi infinite slab undergoes solidification with ΔT changes as well as results of increase in the resistance. For the forgoing reasons the characteristic time is very small.

Solidification time

Miller's approach

Following Eckert's work, Miller and his student (Horacio and Miller1997) altered the calculations¹² and based the assumption that the conduction heat transfer characteristic time in die (liquid metal in solid phase) is the same order magnitude as the solidification time. This assumption leads them to conclude that the main resistance to the solidification is in the interface between the die and mold¹³. Hence they conclude that the solidified front moves according to the following

$$\rho h_s v_n = h \Delta T \quad (3.19)$$

¹²Miller and his student calculate the typical forces required for clamping. The calculations Mr. Miller has made show interesting phenomenon in which small casting (2[kg]) requires larger force than heavier casting (20[kg])?! Check it out in their paper page 43 in NADCA Transaction 1997! If the results extrapolated to about 50[kg] casting, no force will be required for clamping. Furthermore, the force for 20 [kg] casting was calculated to be in the range of 4000[N]. In reality this kind of casting will made on 1000 [ton] machine or more (3 order of magnitude larger than Miller calculation suggested). The typical required force should be determined by the plunger force and the machine parts transient characteristics and etc. Guess, how sponsored this research and how much it cost!

¹³Why? What is the logic?

Where here h is the innovative heat transfer coefficient between solid and solid ¹⁴ and v_n is front velocity. Then the filling time is given by the equation

$$t_s = \frac{\rho h_{sl}}{h \Delta T} \ell \quad (3.20)$$

where ℓ designates the half die thickness. As a corollary conclusion one can arrived from this construction is that the filling time is linearly proportional to the die thickness since $\rho h_{sl}/h \Delta T$ is essentially constant (according to Miller). This interesting conclusion contradicts all the previous research about solidification problem (also known as the Stefan problem). The author not aware of any solidification problem to show similar results. Of course, Miller has all the experimental evidence to back it up.

Present approach

Heat balance at the liquid-solid interface yields

$$\rho_s h_{sf} v_n = k \frac{\partial(T_l - T_s)}{\partial n} \quad (3.21)$$

where n is perpendicular to the surface and ρ has to be taken at the solid phase see Appendix C. Additionally, note that in many alloys the density change during the solidification is quite substantial which has a significant effect on the moving of the liquid/solid front. We notice that at the die interface $k_s \partial T / \partial n \cong k_d \partial T / \partial n$ and further assume that temperature gradient in the liquid side, $\partial T / \partial n \sim 0$, negligible compared to other fluxes. Hence, the speed of the solid/liquid front moves

$$v_n = \frac{k}{\rho_s h_{sl}} \frac{\partial T_s - T_l}{\partial n} \sim \frac{k \Delta T_{MB}}{\rho_s h_{sl} \tilde{L}} \quad (3.22)$$

The main resistance to the heat transfer from the die to the mold (cooling liquid) is in the die mold. Hence, the characteristic heat transfer from the mold is proportional to $\Delta T_{MB} / \tilde{L}$ ¹⁵. The characteristic temperature difference is between the melting temperature and the boiling temperature. The time scale for the front can be estimated by

$$t_s = \frac{\ell}{v_s} = \frac{\rho_s h_{sl} \ell^2 \left(\frac{\tilde{L}}{\ell} \right)}{k_d \Delta T_{MB}} \quad (3.23)$$

Note that the solidification time isn't a linear function of the die thickness, ℓ , but a function of $\sim (\ell^2)$ ¹⁶.

¹⁴Anyone have any explanation? This coefficient is commonly used either between solid and liquid, or to represent the resistance between two solids. I do not think, and hope, that they refer that this coefficient represents the resistance between the two solids since it is a minor factor and does not determine the characteristic time.

¹⁵The estimate can be improved by converting the resistances of the die to represented die length and the same for the other resistance into the cooling liquid i.e. $\Sigma 1/h_o + \tilde{L}/k + \dots + 1/h_i$.

¹⁶ \tilde{L} can be represented by ℓ for example see the more simplified assumption leads to pure = ℓ^2 .

Dissipation time

Examples how dissipation is governing the flow can be found abundantly in nature. Since the dissipation characteristic time isn't commonly studied in a "regular" fluid mechanics we first introduce two classical examples of dissipation problems. One problem is dealing with the oscillating manometer and two, "rigid body" brought to a rest in a thin cylinder.

Example 3.1

A liquid in manometer is disturbed from a rest by a distance of H . Assume that the flow is laminar and neglected secondary flows. Describe H as function of time. Defined 3 cases: 1) under damping, 2) critical damping, and 3) over damping. Discuss the physical significance of the critical damping. Compute the critical radius to create the critical damping.

Solution

$$\frac{\partial^2 X}{\partial t^2} + \left(\frac{6\mu}{R^2}\right) \frac{\partial X}{\partial t} + \frac{3g}{2L} X = 0 \quad (3.24)$$

Similarity to spring with damping.

Example 3.2

A thin ($t/D \ll 1$) cylinder full with liquid is rotating in a velocity, ω . The rigid body is brought to a stop. Assuming no secondary flows (Bernard's cell, etc.), describe the flow as a function of time. Utilize the ratio $1 \gg t/D$.

Solution

$$\frac{d^2 X}{dt^2} + \left(\frac{\mu}{\ell^2}\right) \frac{dX}{dt} + X = 0 \quad (3.25)$$

Discuss the case of rapid damping, and the case of the characteristic damping

These examples illustrate that the characteristic time of dissipation can be assessed by $\sim \mu(du/dy)^2$ thus given by ℓ^2/ν . Note the analogy between t_s and t_{diss} , for which ℓ^2 appears in both of them, the characteristic length, ℓ , appears as the typical die thickness.

perhaps the examples are not important?

put Eckert's explanation

put more expanded explanation for this equation

Meta

$$\left(\frac{\partial \theta_l}{\partial t} + u \frac{\partial \theta_l}{\partial x} + v \frac{\partial \theta_l}{\partial y} + w \frac{\partial \theta_l}{\partial z}\right) = \alpha_l \left(\frac{\partial^2 \theta_l}{\partial x^2} + \frac{\partial^2 \theta_l}{\partial y^2} + \frac{\partial^2 \theta_l}{\partial z^2}\right) + \mu \Phi \quad (3.26)$$

Where Φ is the dissipation function is defined as

$$\Phi = 2 \left[\left(\frac{\partial u}{\partial x}\right)^2 + \left(\frac{\partial v}{\partial y}\right)^2 + \left(\frac{\partial w}{\partial z}\right)^2 \right] + \left[\frac{\partial v}{\partial x}\right]^2 + \left[\frac{\partial u}{\partial y}\right]^2 + \left[\frac{\partial w}{\partial y}\right]^2 + \left[\frac{\partial v}{\partial z}\right]^2 + \left[\frac{\partial w}{\partial x}\right]^2 + \left[\frac{\partial u}{\partial z}\right]^2 - \frac{2}{3} \left(\frac{\partial u}{\partial x} + \frac{\partial v}{\partial y} + \frac{\partial w}{\partial z}\right)^2 \quad (3.27)$$

End

is it important to discuss the
2/3?

3.4.2 The ratios of various time scales

Now we can look at several time ratios. The ratio of solidification time to filling time

$$\frac{t_f}{t_s} \sim \frac{Lk_d\Delta T_{MB}}{U\rho_s h_{sl}\ell\tilde{L}} = \frac{Ste}{Pr Re} \left(\frac{\rho_{lm}}{\rho_s}\right) \left(\frac{k_d}{k_{lm}}\right) \left(\frac{L}{\tilde{L}}\right) \quad (3.28)$$

where

$$Re \quad \text{Reynolds number } \frac{U\ell}{\nu_{lm}}$$

$$Ste \quad \text{Stefan number } \frac{c_{p,lm}\Delta T_{MB}}{h_{sl}}$$

Here we augment the discussion on the importance of equation (3.28). The ratio is extremely important since it actually define the required filling time.

$$t_f = C \left(\frac{\rho_{lm}}{\rho_s}\right) \left(\frac{k_d}{k_{lm}}\right) \left(\frac{L}{\tilde{L}}\right) \frac{Ste}{Pr Re} \quad (3.29)$$

At the moment, the “constant”, C , is unknown and its value has to come out from experiments. Furthermore, the “constant” is not really a constant and is a very mild function of the geometry. Note that this equation also different from all the previously proposed filling time equations, since it take into account solidification and filling process into account¹⁷.

discuss the geometry shape
effects on this constant

The ratio of liquid metal conduction characteristic time to characteristic filling time is given by

$$\frac{t_{c,d}}{t_f} \sim \frac{U\tilde{L}^2}{L\alpha} = \frac{U\ell}{\nu} \frac{\nu}{\alpha} \frac{\tilde{L}^2}{L\ell} = Re Pr \frac{\tilde{L}^2}{L\ell} \quad (3.30)$$

The solidification characteristic time to conduction characteristic time is given by

$$\frac{t_s}{t_c} \sim \frac{\rho_s h_{sl}\ell\tilde{L}\alpha_d}{k_d\Delta T_{MB}\tilde{L}^2} = \frac{1}{Ste} \left(\frac{\rho_s}{\rho_d}\right) \left(\frac{c_{p,lm}}{c_{p,d}}\right) \left(\frac{\ell}{\tilde{L}}\right) \quad (3.31)$$

The ratio of the filling time and atomization is

$$\frac{t_{a,viscosity}}{t_f} \approx \frac{\nu\ell U}{\sigma L} = Ca \left(\frac{\ell}{L}\right) \sim 6 \times 10^{-8} \quad (3.32)$$

Note that ℓ , in this case, is the thickness of the gate and not of the die cavity.

$$\frac{t_{a,momentum}}{t_f} \approx \frac{\rho\ell^2 U^2}{\sigma L} = We \left(\frac{\ell}{L}\right) \sim 0.184 \quad (3.33)$$

which means that if atomization occurs, it will be very fast compared to the filling process.

¹⁷I have take the liberty to call this equation Eckert-BarMeir's equation. I would like to have a good experimental work so we can add your name to this equation.

Section 3.5. Similarity applied to Die cavity

The ratio of the dissipation time to solidification time is given by

$$\frac{t_{diss}}{t_s} \sim \frac{\ell^2}{\nu_{lm}} \frac{k_d \Delta T_{MB}}{\rho_s h_{sl} \ell \tilde{L}} = \left(\frac{Ste}{Pr} \right) \left(\frac{k_d}{k_{lm}} \right) \left(\frac{\rho_{lm}}{\rho_s} \right) \left(\frac{\ell}{\tilde{L}} \right) \sim 10^0 \quad (3.34)$$

this equation yields typical values for many situations in the range of 10^0 indicating that the solidification process is as fast as the dissipation. It has to be noted that when the solidification progress, the die thickness decreases. The ratio, ℓ/\tilde{L} , reduced as well. As results the last stage of the solidification can be considered as a pure conduction problem as was done by the “english” group.

3.5 Similarity applied to Die cavity

3.5.1 Governing equations

The filling of the mold cavity can be divided into two periods. In the first period (only fluid mechanics; minimum heat transfer/solidification) and the second period in which the solidification and dissipation occur. We discuss how to conduct experiments in die casting¹⁸. It has to stress that the conditions down-stream have to be understood prior to experiment with the die filling. The liquid metal velocity profile and flow pattern are still poorly understood at this stage. However, in this discussion we will assume that they are known or understood to some degree¹⁹.

The governing equations are given in the preceding sections and now we discuss the boundary conditions. The boundary condition at the solid interface for the gas/air and for the liquid metal are assumed to be “no-slip” condition which reads

$$u_g = v_g = w_g = u_{lm} = v_{lm} = w_{lm} = 0 \quad (3.35)$$

where we use the subscript g indicates the gas phase. It noteworthy to mention that this also applied to the case where liquid metal is mixed with air/gas and both are touching the surface. At the interface between the liquid metal and gas/air pressure jump is expressed as

$$\frac{\sigma}{r_1 + r_2} \approx \Delta p \quad (3.36)$$

where r_1 and r_2 are the principal radii of the free surface curvature, and, σ , is the surface tension between the gas and the liquid metal. The surface geometry is determined by several factors which include the liquid movement²⁰ instabilities etc.

Now to the difficult parts, the velocity at gate has to be determined from the pQ^2 diagram or previous studies on the runner and shot sleeve. The difficulties arise due to fact that we cannot assign a specific constant velocity and assume only liquid flow out. It has to be realized that due to the mixing processes in the shot sleeve and the runner (especially in a poor design

put the numbers of governing equations

is it true for large Ma number discussion

¹⁸In this addition I had only time to discuss how to conduct experiments about the filling of the die. In the future, other zones and different processes will be discussed.

¹⁹Again the die casting process is a parabolic process.

²⁰Note the liquid surface cannot be straight, for unsteady state, because it results in no pressure gradient and therefore no movement.

process and runner system, now commonly used in the industry) some portion at the beginning has a significant part which contains air/gas. There are several possibilities that the conditions can be prescribed. The first possibility is to describe the pressure variation at the entrance. The second possibility is to describe the velocity variation (as a function of time). The velocity is reduced during the filling of the cavity and is a function of the cavity geometry. The change in the velocity is a sharp in the initial part of the filling due to the change from a free jet to an immersed jet. The pressure varies also at the entrance, however, the variations are more mild. Thus, it is better possibility²¹ to consider the pressure prescription. The simplest assumption is constant pressure

here is the parabolic process is gone

just to get the average value and to explain how to get the function later

$$p = P_0 = \frac{1}{2}\rho U_0^2 \tag{3.37}$$

We also assume that the air/gas obeys the ideal gas model.

$$\rho_g = \frac{p}{RT} \tag{3.38}$$

where R is the air/gas constant and T is gas/air temperature. Here we must insert the previous assumption of negligible heat transfer and further assume that the process is polytropic²². We define the dimensionless gas density as

$$\rho' = \frac{\rho}{\rho_0} = \left(\frac{p_0}{p}\right)^{\frac{1}{n}} \tag{3.39}$$

check the subscript is systematic

The subscript 0 denotes the atmospheric condition.

The air/gas flow rate out the cavity is assumed to behave according to the model in Chapter 9. Thus, the knowledge of the vent relative area and $\frac{4fL}{D}$ are important parameters. For cases where the vent is well design (vent area is near the critical area or above the density, ρ_g can be determine as was done by (Bar-Meir1995b)).

To study the controlling parameters the equations are dimensionlessed. The mass conservation for the liquid metal becomes

$$\frac{\partial \rho_{lm}}{\partial t'} + \frac{\partial \rho_{lm} u'_{lm}}{\partial x'} + \frac{\partial \rho_{lm} v'_{lm}}{\partial y'} + \frac{\partial \rho_{lm} w'_{lm}}{\partial z'} = 0 \tag{3.40}$$

where $x' = \frac{x}{\ell}$, $y' = \frac{y}{\ell}$, $z' = \frac{z}{\ell}$, $u' = u/U_0$, $v' = v/U_0$, $w' = w/U_0$ and the dimensionless time is defined as $t' = \frac{tU_0}{\ell}$, where $U_0 = \sqrt{2P_0/\rho}$.

Equation (3.40) can be the same simplified under the assumption of constant density to read

$$\frac{\partial u'_{lm}}{\partial x'} + \frac{\partial v'_{lm}}{\partial y'} + \frac{\partial w'_{lm}}{\partial z'} = 0 \tag{3.41}$$

²¹At this stage, we must reserved ourself to an intelligent guessing.

²²There are several possibilities, I have chose this one only to obtain the main controlling parameters.

Section 3.5. Similarity applied to Die cavity

Please note that we cannot use this simplification for the gas phase. The momentum equation for the liquid metal in the x-coordinate assuming constant density and no body forces reads

$$\begin{aligned} \frac{\partial \rho_{lm} u'_{lm}}{\partial t'} + u' \frac{\partial \rho_{lm} u'_{lm}}{\partial x'} + v' \frac{\partial \rho_{lm} u'_{lm}}{\partial y'} + w' \frac{\partial \rho_{lm} u'_{lm}}{\partial z'} = \\ - \frac{\partial p'_{lm}}{\partial x'} + \frac{1}{Re} \left(\frac{\partial^2 u'_{lm}}{\partial x'^2} + \frac{\partial^2 v'}{\partial y'^2} + \frac{\partial^2 w'}{\partial z'^2} \right) \end{aligned} \quad (3.42)$$

where $Re = U_0 \ell / \nu_{lm}$ and $p' = p / P_0$.

The gas phase continuity equation reads

$$\frac{\partial \rho'_g}{\partial t'} + \frac{\partial \rho'_g u'_g}{\partial x'} + \frac{\partial \rho'_g v'_g}{\partial y'} + \frac{\partial \rho'_g w'_g}{\partial z'} = 0 \quad (3.43)$$

The gas/air momentum equation²³ is transformed into

$$\begin{aligned} \frac{\partial \rho'_g u'_g}{\partial t'} + u' \frac{\partial \rho'_g u'_g}{\partial x'} + v' \frac{\partial \rho'_g u'_g}{\partial y'} + w' \frac{\partial \rho'_g u'_g}{\partial z'} = \\ - \frac{\partial p'_g}{\partial x'} + \underbrace{\frac{\nu_{lm} \rho_{g0}}{\nu_g \rho_{lm}} \frac{1}{Re} \left(\frac{\partial^2 u'_g}{\partial x'^2} + \frac{\partial^2 v'_g}{\partial y'^2} + \frac{\partial^2 w'_g}{\partial z'^2} \right)}_{\sim 0} \end{aligned} \quad (3.44)$$

Note that in this equation additional terms were added, $(\nu_{lm} / \nu_g)(\rho_{g0} / \rho_{lm})$.

The “no-slip” conditions are converted to:

$$u'_g = v'_g = w'_g = u'_{lm} = v'_{lm} = w'_{lm} = 0 \quad (3.45)$$

The surface between the liquid metal and the air satisfy

$$p'(r'_1 + r'_2) = \frac{1}{We} \quad (3.46)$$

where the p' , r'_1 , and r'_2 are defined as $r'_1 = r_1 / \ell$ $r'_2 = r_2 / \ell$

The solution to equations has the form of

$$\begin{aligned} u' &= f_u \left(x', y', z', Re, We, \frac{A}{AC}, \frac{4fL}{D}, n, \frac{\rho_g}{\rho_{lm}}, \frac{\nu_{lm}}{\nu_g} \right) \\ v' &= f_v \left(x', y', z', Re, We, \frac{A}{AC}, \frac{4fL}{D}, n, \frac{\rho_g}{\rho_{lm}}, \frac{\nu_{lm}}{\nu_g} \right) \\ w' &= f_w \left(x', y', z', Re, We, \frac{A}{AC}, \frac{4fL}{D}, n, \frac{\rho_g}{\rho_{lm}}, \frac{\nu_{lm}}{\nu_g} \right) \\ p' &= f_p \left(x', y', z', Re, We, \frac{A}{AC}, \frac{4fL}{D}, n, \frac{\rho_g}{\rho_{lm}}, \frac{\nu_{lm}}{\nu_g} \right) \end{aligned} \quad (3.47)$$

²³In writing this equation it is assumed that viscosity of the air independent of pressure and temperature.

If it will be found that equation (3.44) can be approximated²⁴ by

$$\frac{\partial u'_g}{\partial t'} + u' \frac{\partial u'_g}{\partial x'} + v' \frac{\partial u'_g}{\partial y'} + w' \frac{\partial u'_g}{\partial z'} \approx - \frac{\partial p'_g}{\partial x'} \quad (3.48)$$

then the solution is reduced to

$$\begin{aligned} u' &= f_u \left(x', y', z', Re, We, \frac{A}{AC}, \frac{4fL}{D}, n \right) \\ v' &= f_v \left(x', y', z', Re, We, \frac{A}{AC}, \frac{4fL}{D}, n \right) \\ w' &= f_w \left(x', y', z', Re, We, \frac{A}{AC}, \frac{4fL}{D}, n \right) \\ p' &= f_p \left(x', y', z', Re, We, \frac{A}{AC}, \frac{4fL}{D}, n \right) \end{aligned} \quad (3.49)$$

At this stage we do not know if it the case and it has to come-out from the experiments. The density ratio can play a role because two phase flow characteristic in major part of the filling process.

3.5.2 Design of Experiments

Under Construction ²⁵

3.6 Summary of dimensionless numbers

In this section we summarize all the major dimensionless parameters what effect the die casting process.

Reynolds number

$$Re = \frac{\rho U^2 / \ell}{\nu U / \ell^2} = \frac{\text{inertail Forces}}{\text{viscouse forces}}$$

Reynolds number represent the ratio of the momentum forces to the viscous forces. In die casting Reynolds number play a significant role which determine the flow pattern in the runner and the vent system. The discharge coefficient, C_D , is used in the pQ^2 diagram is determined largely by the Re number through the value of friction coefficient, f , in side the runner.

Eckert number

$$Ec = \frac{1/2\rho U^2}{1/2\rho c_p \Delta T} = \frac{\text{inertial energy}}{\text{termal energy}}$$

Eckert number determines if the role of the momentum energy transferred to thermal energy is significant.

²⁴This topic is controversial in the area of two phase flow.

²⁵see for time being Eckert's paper

Section 3.6. Summary of dimensionless numbers

Brinkman number

$$Br = \frac{\mu U^2 / \ell^2}{k \Delta T / \ell^2} = \frac{\text{heat production by viscous dissipation}}{\text{heat transfer transport by conduction}}$$

Brinkman number is a measure of the importance of the viscous heating relative the conductive heat transfer. This number is important in cases where large velocity changes occurs over short distances such as lubricant flow (perhaps, flow in the gate). In die casting this number has small values indicating that practically the viscous heating is not important.

Mach number

$$Ma = \frac{U}{\sqrt{\frac{\gamma \partial p}{\partial \rho}}}$$

For ideal gas (good assumption for the mixture of the gas leaving the cavity). It becomes

$$Ma \cong \frac{U}{\sqrt{\gamma RT}} = \frac{\text{characteristic velocity}}{\text{gas sound velocity}}$$

Mach number determine the characteristic of flow in the vent system where the air/gas velocity is reaching to the speed of sound. The air is choked at the vent exit and in some cases other locations as well for vacuum venting. In atmospheric venting the flow is not choked for large portion of the process. Moreover, the flow, in well design vent system, is not choked. Yet the air velocity is large enough so that the Mach number has to be taken into account for reasonable calculation of the C_D .

Ozer number

$$Oz = \frac{\frac{C_D^2 P_{max}}{\rho}}{\left(\frac{Q_{max}}{A_3}\right)^2} = \left(\frac{A_3}{Q_{max}}\right)^2 C_D^2 \frac{P_{max}}{\rho} = \frac{\text{effective static pressure energy}}{\text{average kinematic energy}}$$

One of the most important number in the pQ^2 diagram calculation is Ozer number. This number represent the how good the runner is designed.

Froude number

$$Fr = \frac{\rho U^2 / \ell}{\rho g} = \frac{\text{inertial forces}}{\text{gravity forces}}$$

Fr number represent the ratio of the gravity forces to the momentum forces. It is very important in determining the critical slow plunger velocity. This number is determined by the height of the liquid metal in the shot sleeve. The Froude number does not play a significant role in the filling of the cavity.

Capillary number

$$Ca = \frac{\rho U^2 / \ell}{\rho g} = \frac{\text{inertial forces}}{\text{gravity forces}}$$

capillary number (Ca) determine when the flow during the filling the cavity is atomized or is continuous flow (for relatively low Re number).

Weber number

$$We = \frac{1/2 \rho U^2}{1/2 \sigma / \ell} = \frac{\text{inertial forces}}{\text{surface forces}}$$

We number is the other parameter that govern the flow pattern in the die. The flow in die casting is atomized and, therefore, We with combinations of the gate design also determining the drops sizes and distribution.

Critical vent area

$$A_c = \frac{V(0)}{ct_{max} M_{max}}$$

The critical area is the area for which the air/gas is well vented.

3.7 Summary

The dimensional analysis demonstrates that the fluid mechanics process, such as filling of the cavity with liquid metal and evacuation/extraction of the air from the mold, can be dealt when the heat transfer is negligible. This proved an excellent opportunity for simple models to predict many parameters in the die casting process which are discussed in this book. It is recommended for interested readers to read Eckert's book "Analysis of Heat and Mass transfer" to have better and more general understanding of this topic.

put ref to the latest Eckert's book.

3.8 Questions

3.3.1 Calculate the liquid metal velocity in transition for typical shot sleeve, runner.

3.3.1 What is the critical velocity for pipe with diameter of 0.1 [m] when critical Re number is 2300?

Under construction

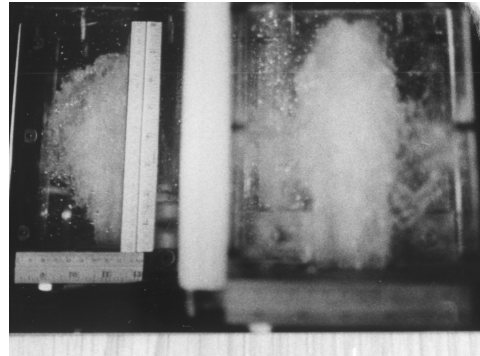

(a)

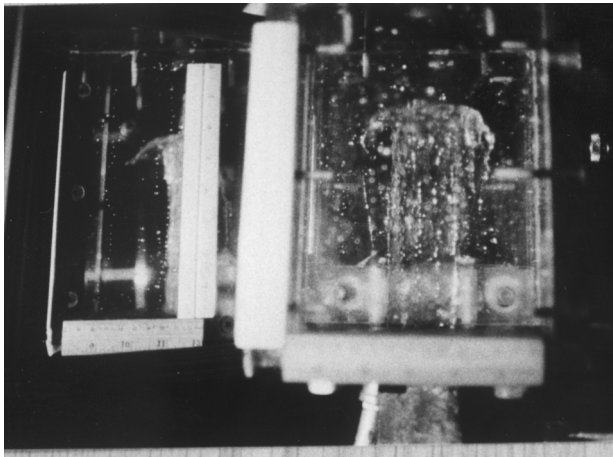

(b)

Figure 3.7: Typical flow pattern in die casting, jet entering into empty cavity

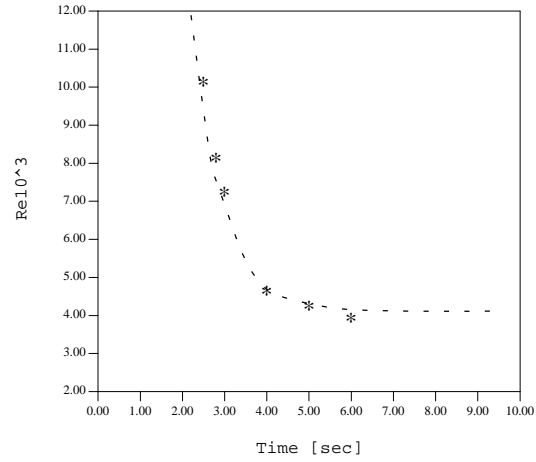

Figure 3.8: Transition to turbulent flow in circular pipe for instantaneous flow after Wygnanski and others by interpolation

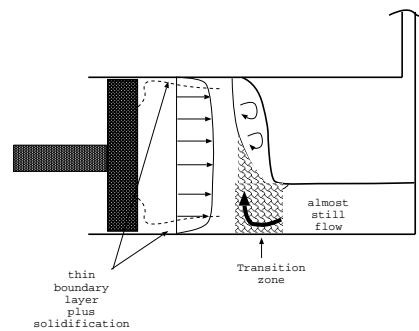

Figure 3.9: Flow pattern in the shot sleeve

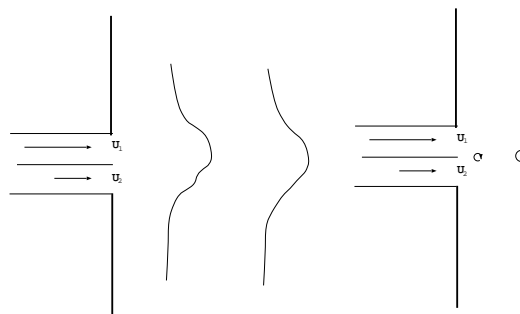

Figure 3.10: Two streams of fluids into a medium

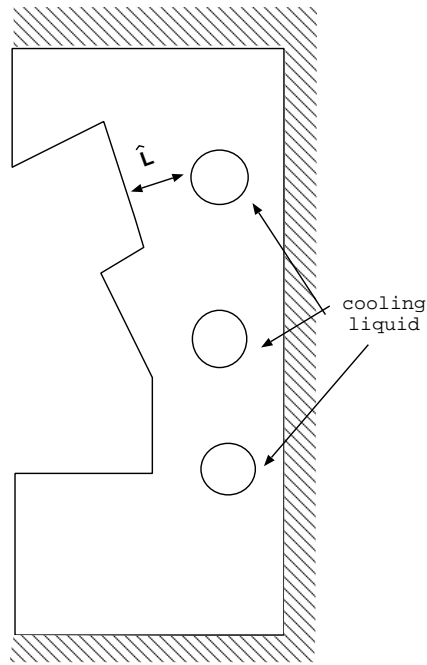

Figure 3.11: Schematic of heat transfer processes in the die

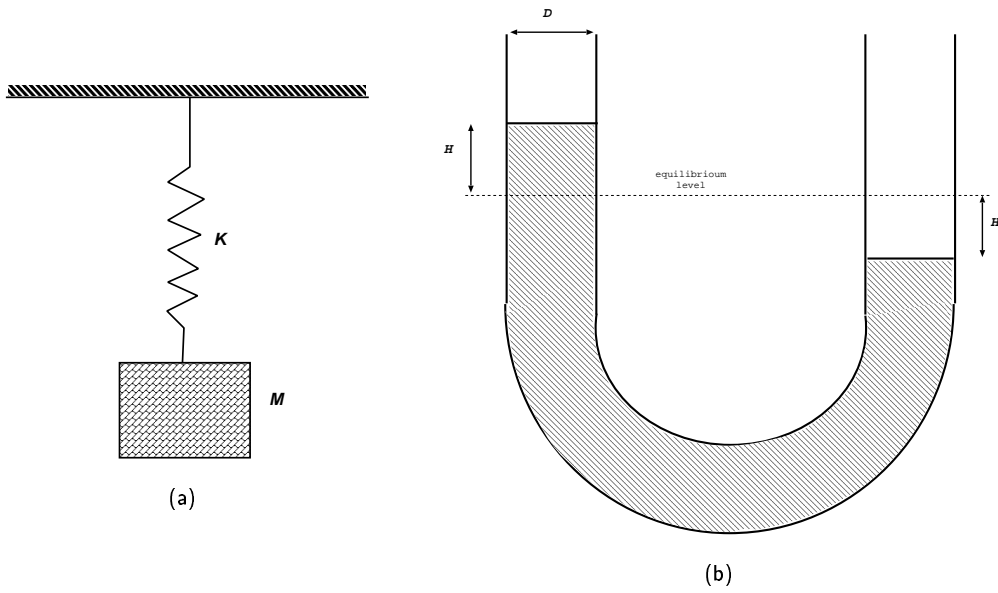

Figure 3.12: The oscillating manometer for the example 3.4.1

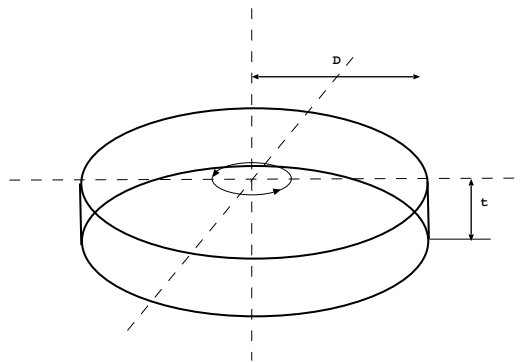

Figure 3.13: Rigid body brought into rest.

CHAPTER 4

Fundamentals of Pipe Flow

Chapter Under construction

4.1 Introduction

The die casting engineer encounters many aspects of network flow. For example, the liquid metal flows in the runner is a network flow. The flow of the air and other gases out of the mold through the vent system is also another example network flow. The pQ^2 diagram also requires intimate knowledge of the network flow. However, most die casting engineers/researchers are unfamiliar with fluid mechanics and furthermore have a limited knowledge and understanding of the network flow. Therefore, this chapter is dedicated to describe a brief introduction to a flow in a network. It is assumed that the reader does not have extensive background in fluid mechanics. However, it is assumed that the reader is familiar with the basic concepts such as pressure and force, work, power. More comprehensive coverage can be found in books dedicated to fluid mechanics and pipe flow (network for pipe). First a discussion on the relevancy of the data found for other liquids to the die casting process is presented. Later a simple flow in a straight pipe/conduit is analyzed. Different components which can appear in network are discussed. Lastly, connection of the components in series and parallel are presented.

Figure 4.1: *Flow in a pipe with an orifice for different liquids*

4.2 Universality of the loss coefficients

Die casting engineers who are not familiar with fluid mechanics ask whether the loss coefficients obtained for other liquids should/could be used for the liquid metal. To answer this question,

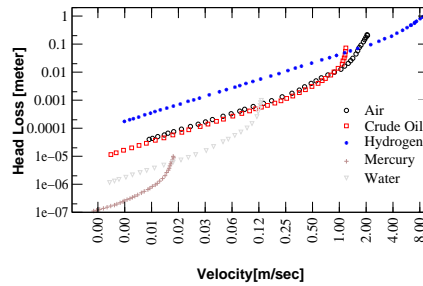

Figure 4.2: The results for the flow in a pipe with orifice

many experiments have been carried out for different liquids flowing in different components in the last 300 years. An example of such experiments is a flow of different liquids in a pipe with an orifice (see Figure 4.1). Different liquids create significant head loss for the same velocity. Moreover, the differences for the different liquids are so significant that the similarity is unclear as shown in Figure 4.2. As the results of the past geniuses work, it can be shown that when results are normalized by Reynolds number (Re) instead of the velocity and when the head loss is replaced by the loss coefficient, $\frac{\Delta H}{U^2/2g}$ one obtains that all the lines are collapsed on to a single line as shown in Figure 4.3. This result indicates that the experimental results obtained for

simplified version of the dimensional analysis. Perhaps to refer to the dim chapter

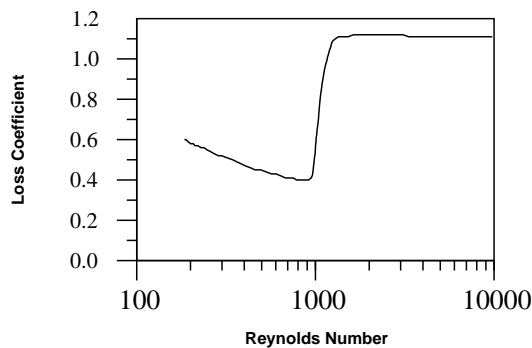

Figure 4.3: The results for the flow in a pipe with orifice

one liquid can be used for another liquid metal provided the other liquid is a Newtonian liquid¹. Researchers shown that the liquid metal behaves as Newtonian liquid if the temperature is above the mushy zone temperature. This example is not correct only for this specific geometry but is correct for all the cases where the results are collapsed into a single line. The parameters which control the problem are found when the results are “collapsed” into a single line. It was found that the resistance to the flow for many components can be calculated (or extracted from experimental data) by knowing the Re number and the geometry of the component. In a way you can think about it as a prof of the dimensional analysis (presented in Chapter ??).

¹Newtonian liquid obeys the following stress law $\tau = \mu \frac{dU}{dy}$

4.3 A simple flow in a straight conduit

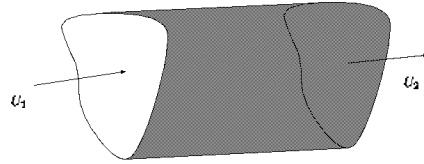

Figure 4.4: General simple conduit description

A simple and most common component is a straight conduit as shown in Figure 4.4. The simplest conduit is a circular pipe which would be studied here first. The entrance problem and the unsteady aspects will be discussed later. The parameters that the die casting engineers interested are the liquid metal velocity, the power to drive this velocity, and the pressure difference occur for the required/desired velocity. What determine these parameters? The velocity is determined by the pressure difference applied on the pipe and the resistance to the flow. The relationship between the pressure difference, the flow rate and the resistance to the flow is given by the experimental equation (4.1). This equation is used because it works². The pressure difference determined by the geometrical parameters and the experimental data which expressed by f^3 which can be obtained from Moody's diagram.

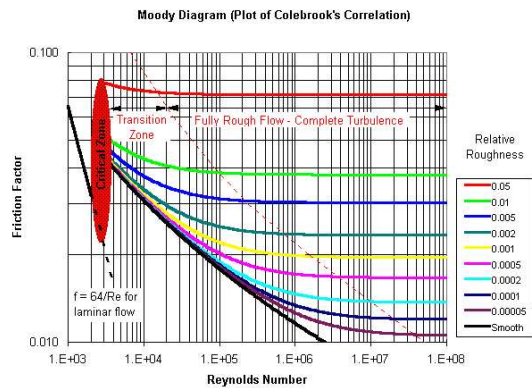

Figure 4.5: Moody's diagram

$$\Delta P = f\rho \frac{L U^2}{D} \frac{1}{2}; \Delta H = f \frac{L U^2}{D} \frac{1}{2g} \quad (4.1)$$

Note, head is energy per unit weight of fluid (i.e. Force x Length/Weight = Length) and it

²Actually there are more reasons but they are out of the scope of this book

³At this stage, we use different definition than one used in Chapter D. The difference is by a factor of 4. Eventually we will adapt one system for the book.

has units of length. Thus, the relationship between the Head (loss) and the pressure (loss) is

$$\Delta P = \frac{\Delta H}{\rho g} \quad (4.2)$$

The resistance coefficient for circular conduit can be defined as

$$K_F = f \frac{L}{D} \quad (4.3)$$

This equation is written for a constant density flow and a constant cross section. The flow rate is expressed as

$$Q = U A \quad (4.4)$$

The cross sectional area of circular is $A = \pi r^2 = \pi D^2/4$, using equation (4.4) and substituting it into equation (4.1) yields

$$\Delta P = f \rho \frac{16 L}{\pi^2 D^3} Q^2 \quad (4.5)$$

The equation (4.5) shows that the required pressure difference, ΔP , is a function of $1/D^3$ which demonstrates the tremendous effect the diameter has on the flow rate. The length, on the other hand, has much less significant effect on the flow rate.

The power which requires to drive this flow is give by

$$P = Q \cdot \mathcal{P} \quad (4.6)$$

These equations are very important in the understanding the economy of runner design, and will be studied in Chapter ?? in more details.

The power in terms of the geometrical parameters and the flow rate is given

$$P = \left\{ \rho \frac{\infty \mathcal{L}}{\pi \epsilon D^3} \right\} Q^3 \quad (4.7)$$

4.3.1 Examples of the calculations

Example 4.1

calculate the pressure loss (difference) for a circular cross section pipe for driving aluminum liquid metal at velocity of 10[m/sec] for a pipe length of 0.5 [m] (like a medium quality runner) with diameter of 5[mm] 10[mm] and 15[mm]

Solution

This is example 4.3.1

Example 4.2

calculate the power required for the above example

Solution

4.4 Typical Components in the Runner and Vent Systems

In the calculations of the runner the die casting engineer encounter beside the straight pipe which was dealt in the previous section but other kind of components. These components include the bend, Y-connection and tangential gate, "regular gate", the extended Y connection and expansion/contraction (including the abrupt expansion/contraction). In this section a general discussion on the good design practice for the different component is presented. A separate chapter is dedicated to the tangential runner due to its complication.

4.4.1 bend

The resistance in the bend is created because a change in the momentum and the flow pattern. Engineers normally convert the bend to equivalent conduit length. This conversion produces adequate results in some cases while in other it might introduce larger error. The knowledge of this accuracy of this conversion is very limited because limited study have been carry out for the characteristic of flows in die casting. From the limited information the author of this book gadered it seem that it is reasonable to carry this conversion for the calculations of liquid metal flow resistance while in the air/liquid metal mixture it far from adequate. Moreover, "hole" of our knowledge of the gas flow in vent system are far more large. Nevertheless, for the engineering purpose at this stage it seem that some of the errors will cancel each other and the end result will be much better.

bad english. change it please

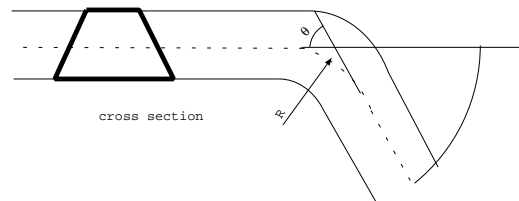

Figure 4.6: A sketch of the bend in die casting

The schematic of a bend commonly used in die casting is shown in Figure 4.6. The resistance of the bend is a function of several parameters: angle, θ , radius, R and the geometry before and after the bend. Commonly, the runner is made with the same geometry before and after the bend. Moreover, we will assume in this discussion that downstream and upstream do not influence that flow in the flow. This assumption is valid when there is no other bend or other change in the flow nearby. In cases that such a change(s) exists more complicated analysis is required.

In the light of the for going discussion, we left with two parameters that control the resistance, the angle, θ , and the radius, R As larger the angle is larger the resistance will be. In the practice today, probably because the way the North American Die Casting Association teaching, excessive angle can be found through the industry. It is recommended never to exceed the straight angle (90^0). Figure 4.7 made from a data taken from several sources. From the Figure it is clear that optimum radius should be around 3

to continue after the figure finished

Figure 4.7: A geometrical description of the resistance in a bend

4.4.2 Y connection

picture of Y connection

The Y-connection represent a split in the runner system. The resistance

4.4.3 Expansion/Contraction

One of the undisable element is the runner system is sudden change in the conduit area. In some instance they are inevodeble. We will discuss how to design and what are the better design options which available for the engineer.

4.5 Putting it all to Together

There are two main kinds of connections; series and parallel. The resistance in the series connection has to be added in a fashion similar to electrical resistance i.e. every resistance has to be added plainly to the total resistance. There are many things that contribute to the resistance besides the regular length, i.e. bends, expansions, contractions etc. All these connections are of series type.

4.5.1 Series Connection

The flow rate in different locations is a function of the temperature. Eckert (Eckert1989) demonstrated that the heat transfer is insignificant in the duration of the filling of the cavity, and therefore the temperature of the liquid metal can be assumed almost constant during the filling period (which in most cases is much less 100 milliseconds). As such, the solidification is insignificant (the liquid metal density changes less than 0.1% in the runner); therefore, the volumetric flow rate can be assumed constant:

$$Q_1 = Q_2 = Q_3 = Q_i \quad (4.8)$$

Clearly, the pressure in the points is different and

$$P_1 \neq P_2 \neq P_3 \neq \Pi \quad (4.9)$$

However the total pressure loss is composed of from all the small pressure loss

$$P_1 - P_{end} = (P_1 - P_2) + (P_2 - P_3) + \dots \quad (4.10)$$

Every single pressure loss can be written as

$$P_{i-1} - \Pi = K_i \frac{U^2}{2} \quad (4.11)$$

There is also resistance due to parallel connection i.e. y connections, y splits and manifolds etc. First, lets look at the series connection (see Figure 4.8). where:

Section 4.5. Putting it all to Together

to add a figure and change it

Figure 4.8: *A connection in series*

K_{bend} the resistance in the bend
 L length of the duct (vent),
 f friction factor, and

4.5.2 Parallel Connection

An example of the resistance of parallel connection (see Figure ??).

The pressure at point 1 is the same for two branches however the total flow rate is the combination

$$Q_{total} = Q_i + Q_j \quad (4.12)$$

between two branches and the loss in the junction is calculated as

To add a figure and check if the old one is good

Figure 4.9: A parallel connection

CHAPTER 5

Flow in Open Channels

5.1 Introduction

One of the branches of the fluid mechanics discussed in Chapter 2. Here we expand this issue further because it is give the basic understanding to the “wave” phenomenon. There are numerous books that dealing with open channel flow and the interested reader can broader his/her knowledge by reading book such as Open-Channel Hydraulics by Ven Te Chow (New York: McGraw-Hill Book Company, Inc. 1959). Here a basic concepts for the non-Fluid Mechanics Engineers are given.

:w

The flow in open channel flow in steady state is balanced by between the gravity forces and mostly by the friction at the channel bed. As one might expect, the friction factor for open channel flow has similar behavior to to one of the pipe flow with transition from laminar flow to the turbulent at about $Re \sim 10^3$. Nevertheless, the open channel flow has several respects the cross section are variable, the surface is at almost constant pressure and the gravity force are important.

to be continue

The flow of a liquid in a channel can be characterized by the specific energy that is associated with it. This specific energy is comprised of two components: the hydrostatic pressure and the liquid velocity¹.

The energy at any point of height in a rectangular channel is

$$e = \frac{\bar{U}^2}{2g} + \frac{P}{\rho} + z \quad (5.1)$$

why? explain

¹The velocity is an average velocity

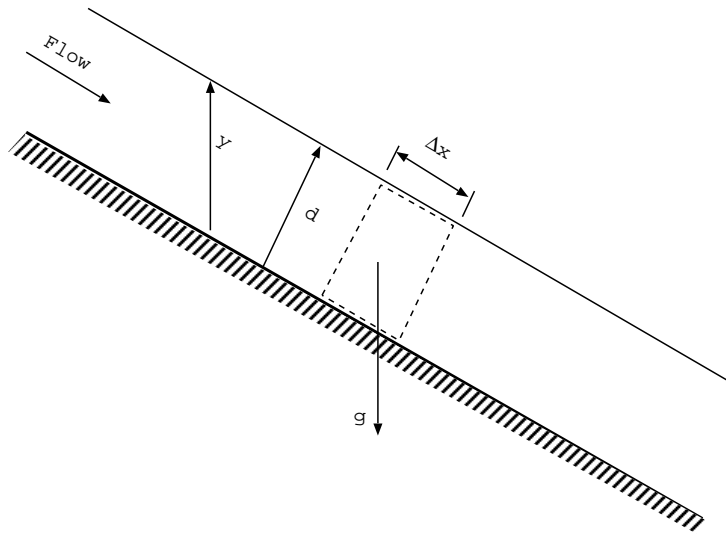

Figure 5.1: Equilibrium of Forces in an open channel

and, since $\frac{P}{\rho} + z = y$ for any point in the cross section (free surface),

$$e = y + \frac{\bar{U}^2}{2g} \quad (5.2)$$

where:

e	specific energy per unit
y	height of the liquid in the channel
g	acceleration of gravity
\bar{U}	average velocity of the liquid

If the velocity of the liquid is increased, the height, y , has to change to keep the same flow rate $Q = qb = by\bar{U}$. For a specific flow rate and cross section, there are many combinations of velocity and height. Plotting these points on a diagram, with the y -coordinate as the height and the x -coordinate as the specific energy, e , creates a parabola on a graph. This line is known as the "specific energy curve". Several conclusions can be drawn from Figure 5.2. First, there is a minimum energy at a specific height known as the "critical height". Second, the energy increases with a decrease in the height when the liquid height is below the critical height. In this case, the main contribution to the energy is due to the increase in the velocity. This flow is known as the "supercritical flow". Third, when the height is above the critical height, the energy increases again. This flow is known as the "subcritical flow", and the energy increase is due to the hydrostatic pressure component.

The minimum point of energy curve happens to be at

$$\bar{U} = \sqrt{gy_c} \quad (5.3)$$

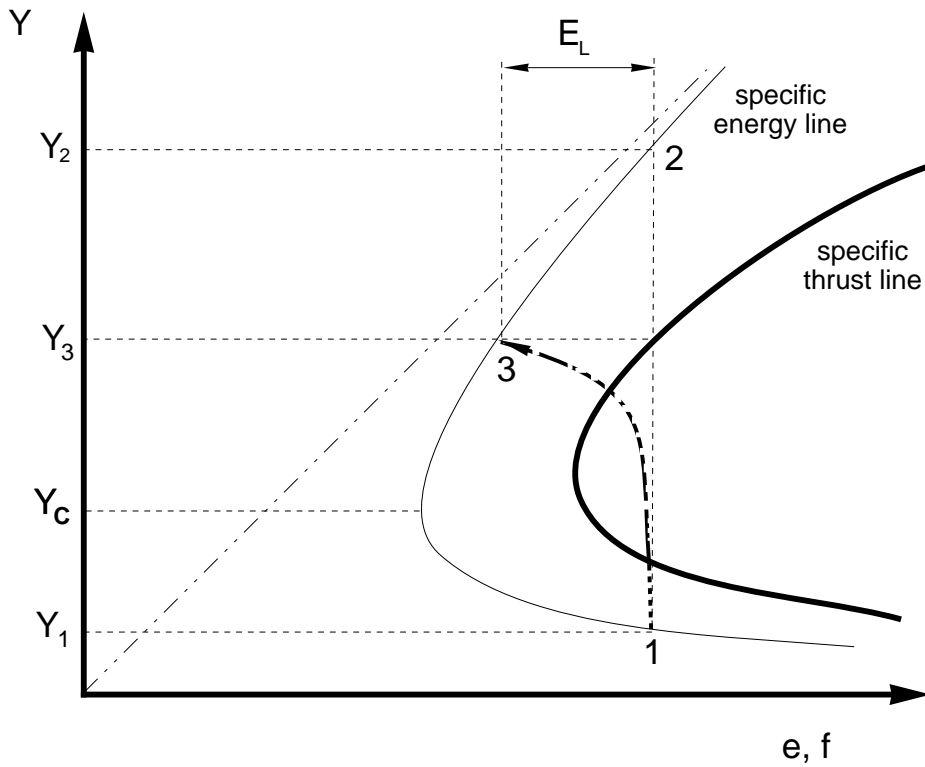

Figure 5.2: Specific Energy and momentum Curves

where the critical height is defined by

$$y_c = \sqrt[3]{\frac{q^2}{g}} \quad (5.4)$$

Thrust is defined as

$$f = \frac{y^2}{2} + y \frac{\bar{U}^2}{g} \quad (5.5)$$

The minimum thrust also happens to be at the same point $\bar{U} = \sqrt{gy}$. Therefore, one can define the dimensionless number as:

$$Fr = \frac{gy_h}{\bar{U}^2} \quad (5.6)$$

Dividing the velocity by \sqrt{gy} provides one with the ability to check if the flow is above or below critical velocity. This quantity is very important, and its significance can be studied from many books on fluid mechanics. The gravity effects are “measured” by the Froude number which is defined by equation (5.6).

5.2 Typical diagrams

5.3 Hydraulic Jump

The flow can change only from a supercritical flow to a subcritical flow, in which the height increases and the velocity decreases. There is no possibility for the flow to go in the reverse direction because of the Second Law of Thermodynamics (the explanation of which is out of the scope of this discussion). If there is no energy loss, the flow moves from point 1 to point 2 in Figure 5.2. In actuality, energy loss occurs in any situation, but sometimes it can be neglected in the calculations. In cases where the flow changes rapidly (such as with the hydraulic jump), the energy loss **must** be taken into account. In these cases, the flow moves from point 1 to point 3 and has energy loss (E_L). In many cases the change in the thrust is negligible, such as the case of the hydraulic jump, and the flow moves from point 1 to point 3 as shown in Figure 5.2.

In 1981, Garber “found” the hydraulic jump in the shot sleeve which he called a “wave”. Garber built a model to describe this wave, utilizing mass conservation and Bernoulli’s equation (energy conservation). This model gives a set of equations relating plunger velocity and wave velocity to other geometrical properties of the shot sleeve. Over 150 years earlier, Bélanger (Bélanger1828) demonstrated that the energy is dissipated, and that energy conservation models cannot be used to solve hydraulic jump. He demonstrated that the dissipation increases with the increase of the liquid velocity before the jump. This conclusion is true for any kind of geometry.

A literature review demonstrates that the hydraulic jump in a circular cross-section (like in a shot sleeve) appears in other cases, for example a flow in a storm sewer systems. An analytical solution that describes the solution is Bar–Meir’s formula and is shown in Figure 8.4.

The energy loss concept manifests itself in several designs, such as in the energy–dissipating devices, in which hydraulic jumps are introduced in order to dissipate energy. The energy–dissipating devices are so common that numerous research works have been performed on them in the last 200 hundreds years. An excellent report by the U.S. Bureau of Reclamation (Branch1958) shows the percentage of energy loss. However, Garber, and later other researchers from Ohio State University (Brevick, Armentrout and Chu1994), failed to know/understand/use this information.

Part II

DIE CASTING DESIGN

CHAPTER 6

Runner Design

Under construction please ignore the rest of the chapter.

6.1 Introduction

In this chapter the design and the different relationship between runner sections are studied herein. The first step in runner design is to divide the mold into several logical sections. The volume of every section has to be calculated. Then the design has to ensure that the gate velocity and the filling time of every section to be as recommended by experimental results. At this stage there is no known reliable theory/model known to the author to predict these values. The values are based heavily on semi-reliable experiments. The Backward Design is discussed. The reader with knowledge in electrical engineering (electrical circuits) will notice in some similarities. However, hydraulic circuits are more complex. Part of the expressions are simplified to have analytical expressions. Yet, in actuality all the terms should be taken into considerations and commercial software such as DiePerfect™ should be used.

6.1.1 Backward Design

Suppose that we have n sections with n gates. We know that volume to be delivered at gate i and is denoted by V_i . The gate velocity has to be in a known range. The filling time has to be in a known function and we recommend to use Eckert/Bar–Meir's formula. For this discussion it is assumed that the filling has to be in known range and the flow rate can be calculated by

$$Q_i = \frac{V_i}{t_i} \tag{6.1}$$

Thus, gate area for the section

$$A_i = \frac{Q_i}{U_{gate}} \tag{6.2}$$

To vent in the picture. To put ref to the picture

Armed with this knowledge, one can start design the runner system.

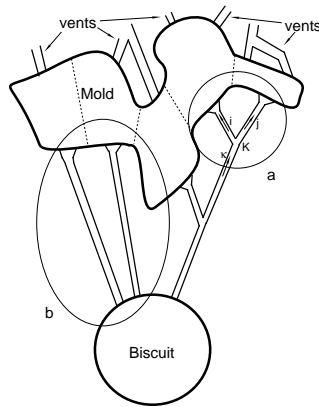

Figure 6.1: A geometry of runner connection

6.1.2 Connecting runner segments

Design of connected runner segments have insure that the flow rate at each segment has to be designed one. In Figure 6.1a branches i and j are connected to branch κ at point K. The pressure drop (difference) on branches i and j has to be the same since the pressure in the mold cavity is the same for both segments. The sum of the flow rates for both branch has to be equal to flow rate in branch κ

$$Q_{\kappa} = Q_i + Q_j \implies Q_j = Q_{\kappa} - Q_i \quad (6.3)$$

The flow rate in every branch is related to the pressure difference by

$$Q_i = \frac{\Delta P}{R_i} \quad (6.4)$$

Where the subscript i in this case also means any branch e.g. i, j and so on. For example, one can write for branch j

$$Q_j = \frac{\Delta P}{R_j} \quad (6.5)$$

Utilizing the mass conservation for point K in which $Q_{\kappa} = Q_i + Q_j$ and the fact that the pressure difference, ΔP , is the same thus we can write

$$Q_k = \frac{\Delta P}{R_i} + \frac{\Delta P}{R_j} = \Delta P \frac{R_i R_j}{R_i + R_j} \quad (6.6)$$

where we can define equalent resistance by

$$\bar{R} = \frac{R_i R_j}{R_i + R_j} \quad (6.7)$$

Section 6.1. Introduction

Lets further manipolte the equations to get some more important relationships. Using equation (??) and equation (??)

$$\Delta P_i = \Delta P_j \implies Q_i R_i = Q_j R_j \quad (6.8)$$

The flow rate in a branch j can be related to flow rate in branch i and corresponding resistances

$$Q_j = \frac{R_i}{R_j} Q_i \quad (6.9)$$

Using equation (??) and equation (??) one can obtain

$$\frac{Q_i}{Q_k} = \frac{R_j}{R_j + R_i} \quad (6.10)$$

Solving for the resistance ratio since the flow rate is known

$$\frac{R_i}{R_j} = \frac{Q_i}{Q_k} - 1 \quad (6.11)$$

6.1.3 Resistance

What does the resistance include? How to achieve resistance ratio in the previous equation (??) will be discussed herein further. The total resistance reads

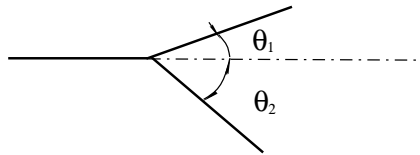

Figure 6.2: y connection

$$R = R_{ii} + R_{\theta} + R_{geometry} + R_{contraction} + R_{ki} + R_{exit} \quad (6.12)$$

The contraction resistance, $R_{contraction}$, is the due the contraction of the gate. The exit resistance, R_{exit} , is due to resistence of the liquid metal in mold cavity. Or in other words, the exit resistance is due the lost of energy of emersed jet. The angle resistance, R_{θ} is due to the change of direction. The R_{ki} is the resistance due to flow in the branch κ on branch i . The geometry resistance $R_{geometry}$, is due to who rounded the connection.

$$\frac{\Delta P}{\rho} = f \frac{L}{H_D} \frac{U^2}{2} \quad (6.13)$$

since $U_i = \frac{Q_i}{A}$

$$\frac{\Delta P}{\rho} = f \frac{L}{H_D} \frac{Q_i^2}{2A^2} \quad (6.14)$$

$$\frac{\Delta P}{\rho} = (C)f \frac{L}{H_D^3} \frac{Q_i^2}{2} \quad (6.15)$$

Lets assume further that $L_i = L_j$, $\frac{Q_i}{Q_j} = \text{known}$

$$f_i = f_j = f \quad (6.16)$$

$$(C)f \frac{L}{H_{D_i}^3} \frac{Q_i^2}{2} = (C)f \frac{L}{H_{D_j}^3} \frac{Q_j^2}{2} \quad (6.17)$$

$$\frac{H_{D_i}}{H_{D_j}} = \left(\frac{Q_i}{Q_j} \right)^{\frac{2}{3}} \quad (6.18)$$

Comparison between scrap between (multi-lines) two lines to one line
first find the diameter equivalent to two lines

$$\Delta P = (C)f \frac{L}{2} \frac{Q_k^2}{H_{D_k}^3} = (C)f \frac{L}{2} \frac{(Q_i + Q_j)^2}{H_{D_k}^3} \quad (6.19)$$

$$Q_i^2 = \frac{\Delta P}{f} \frac{2}{L} H_{D_i}^3 \quad (6.20)$$

subtitling in to

$$\overline{H_{D_k}} = \sqrt[3]{(H_{D_i}^3 + H_{D_j}^3)} \quad (6.21)$$

Now we know the relationship between the hydraulic radius. Let see what is the scrap difference between them.

put drawing of the trapezoid

let scrap denoted by η

converting the equation

$$H_{Di} = \sqrt[3/2]{\frac{\eta_i}{constL}} \quad (6.22)$$

the ratio of the scrap is

$$\frac{\eta_i + \eta_j}{\eta_k} = \frac{(H_{Di} + 2 + H_{Dj}^2)}{H_{Dk}^2} \quad (6.23)$$

and now lets write H_{Dk} in term of the two other

$$\frac{(H_{Di}^2 + H_{Dj}^2)}{(H_{Di}^3 + H_{Dj}^3)^{2/3}} \quad (6.24)$$

CHAPTER 7

PQ² Diagram Calculations

In conclusion, it's just a plain sloppy piece of work.

Referee II, see In the appendix A

Contents

7.1	Introduction	68
7.2	The “common” pQ² diagram	68
7.3	The validity of the “common” diagram	74
7.3.1	Is the “common” model valid?	74
7.3.2	Are the trends reasonable?	76
	Plunger area/diameter variation	76
	Gate area variation	77
	Energy conservation (power supply machine characteristic)	77
	Energy conservation (power supply)	77
	Energy conservation (dissipation problem)	77
	Mass conservation (strike)	78
	Mass conservation (hydraulic pump):	78
7.3.3	Variations of the Gate area, A_3	78
7.4	The reformed pQ² diagram	79
7.4.1	The reform model	79
7.4.2	Examining the solution	81
	The gate area effects	81
	Q_{max} effect	81
	$(A_3/A_1)^2$ effects	81
	K_F effects	82
	The combined effects	83
	General conclusions from example 7.4.2	85

The die casting machine characteristic effects	86
Plunger area/diameter effects	89
Machine size effect	93
Precondition effect (wave formation)	94
7.4.3 Poor design effects	94
7.4.4 Transient effects	94
7.5 Design Process	94
7.6 The Intensification Consideration	95
7.7 Summary	96
7.8 Questions	96

7.1 Introduction

The pQ² diagram is the most common calculation, if any at all, are used by most die casting engineers. The importance of this diagram can be demonstrated by the fact that tens of millions of dollars have been invested by NADCA, NSF, and other major institutes here and abroad in the pQ² diagram research. The pQ² diagram is one of the manifestations of supply and demand theory which was developed by Alfred Marshall (1842–1924) in the turn of the century. It was first introduced to the die casting industry in the late'70s (Davis1975). In this diagram, an engineer insures that die casting machine ability can fulfill the die mold design requirements; the liquid metal is injected at the right velocity range and the filling time is small enough to prevent premature freezing. One can, with the help of the pQ² diagram, and by utilizing experimental values for desired filling time and gate velocities improve the quality of the casting.

perhaps put this section in general discussion

In the die casting process (see Figure 7.1), a liquid metal is poured into the shot sleeve where it is propelled by the plunger through the runner and the gate into the mold. The gate thickness is very narrow compared with the averaged mold thickness and the runner thickness to insure that breakage point of the scrap occurs at that gate location. A solution of increasing the discharge coefficient, C_D, (larger conduits) results in a larger scrap. A careful design of the runner and the gate is required.

First, the “common” pQ² diagram¹ is introduced. The errors of this model are analyzed. Later, the reformed model is described. Effects of different variables is studied and questions for students are given in the end of the chapter.

7.2 The “common” pQ² diagram

The injection phase is (normally) separated into three main stages which are: slow part, fast part and the intensification (see Figure 7.2). In the slow part the plunger moves in the critical velocity to prevent wave formation and therefore expels maximum air/gas before the liquid metal enters the cavity. In the fast part the cavity supposed to be filled in such way to prevent

¹as this model is described in NADCA's books

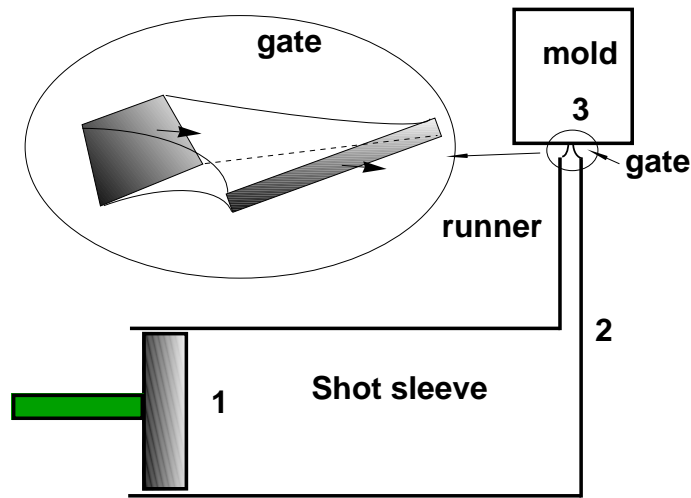

Figure 7.1: Schematic of typical die casting machine

premature freezing and to obtain the right filling pattern. The intensification part is to fill the cavity with additional material to compensate for the shrinkage porosity during the solidification process. The pQ^2 diagram deals with the second part of the filling phase.

In the pQ^2 diagram, the solution is determined by finding the intersecting point of the runner/mold characteristic line with the pump (die casting machine) characteristic line. The intersecting point sometime referred to as the operational point. The machine characteristic line is assumed to be understood to some degree and it requires finding experimentally two coefficients. The runner/mold characteristic line requires knowledge on the efficiency/discharge coefficient, C_D , thus it is an essential parameter in the calculations. Until now, C_D has been evaluated either experimentally, to be assigned to specific runner, or by the liquid metal properties ($C_D \propto \rho$) (Cocks1986) which is de facto the method used today and referred herein as the “common” pQ^2 diagram². Furthermore, C_D is assumed constant regardless to any change in any of the machine/operation parameters during the calculation. The experimental approach is arduous and expensive, requiring the building of the actual mold for each attempt with average cost of \$5,000–\$10,000 and is rarely used in the industry³. A short discussion about this issue is presented in the Appendix A comments to referee 2.

Herein the “common” model (constant C_D) is constructed. The assumptions made in the construction of the model as following

1. C_D assumed to be constant and depends only the metal. For example, NADCA recommend different values for aluminum, zinc and magnesium alloys.

²Another method has been suggested in the literature in which the C_D is evaluated based on the volume to be filled (Cocks and Wall1983). The author does not know of anyone who use this method and therefore is not discussed in this book. Nevertheless, this method is as “good” as the “common” method.

³if you now of anyone who use this technique please tell me about it.

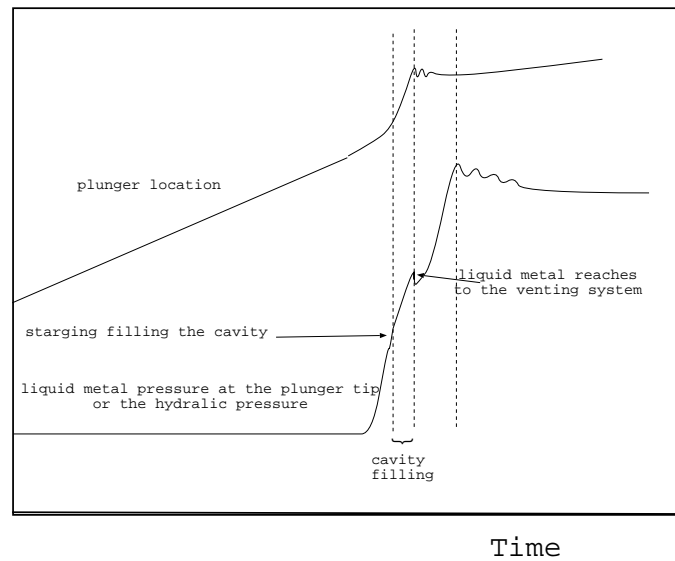

Figure 7.2: A typical trace on a cold chamber machine

2. Many terms in Bernoulli's equation can be neglected.
3. The liquid metal is reached to gate.
4. No air/gas is present in the liquid metal.
5. No solidification occurs during the filling.
6. The main resistance to the metal flow is in the runner.
7. A linear relationship between the pressure, P_1 and flow rate (squared), Q^2 .

According to the last assumption, the liquid metal pressure at the plunger tip, P_1 , can be written as

$$P_1 = P_{max} \left[1 - \left(\frac{Q}{Q_{max}} \right)^2 \right] \quad (7.1)$$

Where:

- P_1 the pressure at the plunger tip
 Q the flow rate
 P_{max} maximum pressure which can be attained by the die casting machine in the shot sleeve
 Q_{max} maximum flow rate which can be attained in the shot sleeve

The P_{max} and Q_{max} values to be determined for every set of the die casting machine and the shot sleeve. The P_{max} value can be calculated using a static force balance. The

Section 7.2. The “common” pQ² diagram

determination of Q_{max} value is done by measuring the velocity of the plunger when the shot sleeve is empty. The maximum velocity combined with the shot sleeve cross-sectional area yield the maximum flow rate,

$$Q_i = A \times U_i \quad (7.2)$$

where i represent any possible subscription e.g. $i = max$

Thus, the first line can be drawn on pQ² diagram as it shown by the line denoted as 1 in Figure 7.3. The line starts from a higher pressure (P_{max}) to a maximum flow rate (squared). A new combination of the same die casting machine and a different plunger diameter creates a different line. A smaller plunger diameter has a larger maximum pressure (P_{max}) and different maximum flow rate as shown by the line denoted as 2.

The maximum flow rate is a function of the maximum plunger velocity and the plunger diameter (area). The plunger area is a obvious function of the plunger diameter, $A = \pi D^2/4$. However, the maximum plunger velocity is a far-more complex function. The force that can be extracted from a die casting machine is essentially the same for different plunger diameters. The change in the resistance as results of changing the plunger (diameter) depends on the conditions of the plunger. The “dry” friction will be same what different due to change plunger weight, even if the plunger conditions where the same. Yet, some researchers claim that plunger velocity is almost invariant in regard to the plunger diameter⁴. Nevertheless, this piece of information has no bearing on the derivation in this model or reformed one, since we do not use it.

A simplified force balance on the rode yields (see more details in section 7.4.2 page 89)

$$P_{max} = P_B \left(\frac{D_B}{D_1} \right)^2 = \frac{P_B}{D_1^2} D_B^2 \quad (7.3)$$

where subscript B denotes the actuator.

Example 7.1

What is the pressure at the plunger tip when the pressure at the actuator is 10 [bars] with diameter of 0.1[m] and with a plunger diameter, D_1 , of 0.05[m]?

Solution

Substituting the data into equation (7.3) yields

$$P_1 = 10 \times \left(\frac{0.1}{0.05} \right)^2 = 4.0 [MPa]$$

In the “common” pQ² diagram C_D is defined as

$$C_D = \sqrt{\frac{1}{1 + K_F}} = constant \quad (7.4)$$

⁴More research is need on this aspect.

++ read the comment made by referee II to the paper on pQ² on page 126.

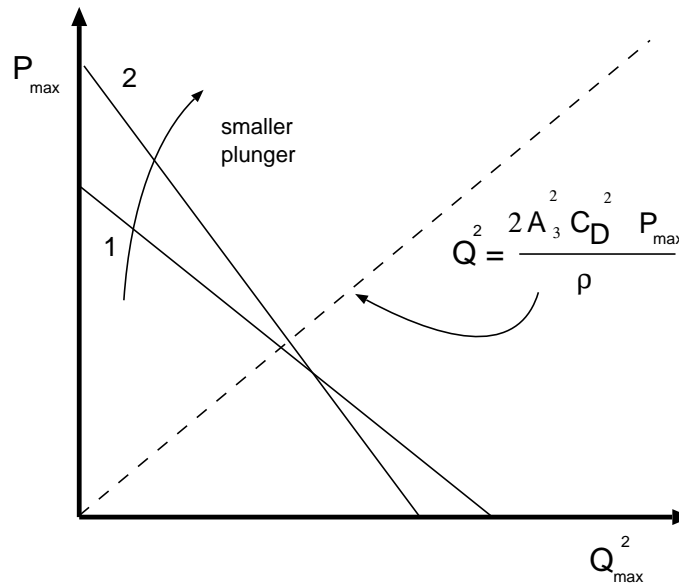

Figure 7.3: The “common” pQ^2 version

Note, therefore K_F is also defined as a constant for every metal⁵. Utilizing Bernoulli’s equation⁶.

$$U_3 = C_D \sqrt{\frac{2P_1}{\rho}} \tag{7.5}$$

The flow rate at the gate can be expressed as

$$Q_3 = A_3 C_D \sqrt{\frac{2P_1}{\rho}} \tag{7.6}$$

The flow rate in different locations is a function of the temperature. However, Eckert (Eckert1989)⁷ demonstrated that the heat transfer is insignificant in the duration of the filling of the cavity, and therefore the temperature of the liquid metal can be assumed almost constant during the filling period (which in most cases is much less 100 milliseconds). As such, the solidification is insignificant (the liquid metal density changes less than 0.1% in the runner); therefore, the volumetric flow rate can be assumed constant:

$$Q_1 = Q_2 = Q_3 = Q \tag{7.7}$$

to make question about mass balance

⁵The author would like to learn who came-out with this “clever” idea.

⁶for more details see section 7.4 page 79.

⁷read more about it in Chapter 3.

Section 7.2. The “common” pQ^2 diagram

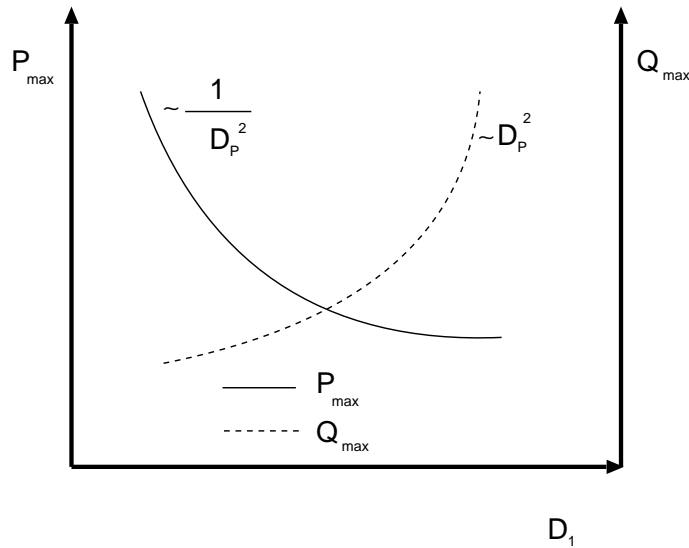

Figure 7.4: P_{max} and Q_{max} as a function of the plunger diameter according to “common” model.

Hence, we have two equations (7.1) and (7.6) with two unknowns (Q and P_1) for which the solution is

$$P_1 = \frac{P_{max}}{1 - \frac{2C_D^2 P_{max} A_3^2}{\rho Q_{max}^2}} \quad (7.8)$$

Example 7.2

What is the pressure at plunger tip (metal side), the flow rate and gate velocity when the following are given: liquid metal material is aluminum, $P_{max} = [5] \text{MPa}$, $Q_{max} = 0.016 [\text{m}^3/\text{sec}]$ and the gate area $3 \times 10^{-5} [\text{m}^2]$? Use NADCA's recommended value of $C_D = 0.55$ ($K_F \approx 3.3$).

Solution

Utilizing equation (7.8)

$$P_1 = \frac{5}{1 - \frac{2 \times (0.55)^2 \times 5 \times (3 \times 10^{-5})^2}{2350 \times 0.016^2}}$$

the gate velocity can be obtained by utilizing equation (7.5)

$$U_3 = 0.55 \sqrt{\frac{2 \times P_1}{2350}}$$

The flow rate can be obtained by utilizing equation (7.2)

$$Q = \quad \times 3 \times 10^{-5}$$

Example 7.3

Repeat previous example with C_D ranging from 0.4 to 0.9 draw a diagram

Solution

under construction

insert a discussion in regards to the trends

insert the calculation with respect to $\frac{dU_3}{dA_1}$ and $\frac{dP_1}{dA_1}$

7.3 The validity of the “common” diagram

In the construction of the “common” model, two main assumptions were made: one C_D is a constant which depends only on the liquid metal material, and two) many terms in the energy equation (Bernoulli's equation) can be neglected. Unfortunately, the examination of the validity of these assumptions was missing in all the previous studies. Here, the question when the “common” model valid or perhaps whether the “common” model valid at all is examined. Some argue that even if the model is wrong and do not stand on sound scientific principles, it still has a value if it produces reasonable trends. Therefore, this model should produce reasonable results and trends when varying any parameter in order to have any value. Part of the examination is done by varying parameters and checking to see what happen to trends.

7.3.1 Is the “common” model valid?

Is the mass balance really satisfied in the “common” model? Lets examine this point. Equation (7.7) states that the mass (volume, under constant density) balance is exist.

$$A_1 U_1 = A_3 U_3 \quad (7.9)$$

So, what is the condition on C_D to satisfy this condition? Can C_D be a constant as stated in assumption 1? To study this point let derive an expression for C_D . Utilizing equation (7.5) yields

$$A_1 U_1 = A_3 C_D \sqrt{\frac{P_1}{\rho}} \quad (7.10)$$

From the machine characteristic, equation (7.1), it can be shown that

$$U_1 = U_{max} \sqrt{P_{max} - P_1} \quad (7.11)$$

Substituting equation (7.11) into equation (7.10) yield,

$$A_1 U_{max} \sqrt{P_{max} - P_1} = A_3 C_D \sqrt{\frac{P_1}{\rho}} \quad (7.12)$$

It can be shown that equation (7.12) can be transformed into

$$C_D = \frac{A_1}{A_3} \frac{U_{max} \sqrt{\rho}}{\sqrt{P_{max} - P_1}} \quad (7.13)$$

Section 7.3. The validity of the “common” diagram

According to the “common” model U_{max} , and P_{max} are independent of the gate area, A_3 . The term $A_3 \sqrt{\frac{P_1}{P_{max}-P_1}}$ is not a constant and is a function of A_3 (possibly other parameters). To maintain the mass balance C_D must be a function at least of the gate area, A_3 . Since the “common” pQ^2 diagram assumes that C_D is a constant it diametrically opposite the mass conservation principle. Moreover, in the “common” model, a major assumption is that the value of C_D depends on the metal, therefore, the mass balance is probably never achieved in many cases. This violation demonstrates, once for all, that the “common” pQ^2 diagram is erroneous.

Example 7.4

Use the information from example 7.2 and check what happened to the flow rate at two location (1) gate 2) plunger tip) when discharge coefficient is varied $C_D= 0.4-0.9$

Solution

under construction

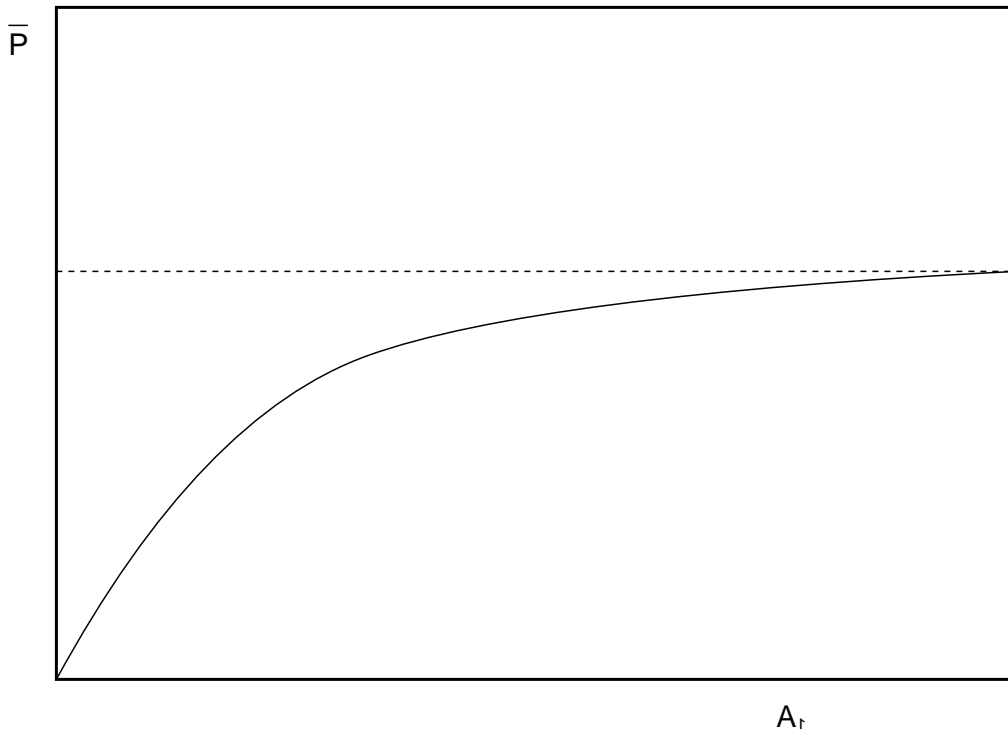
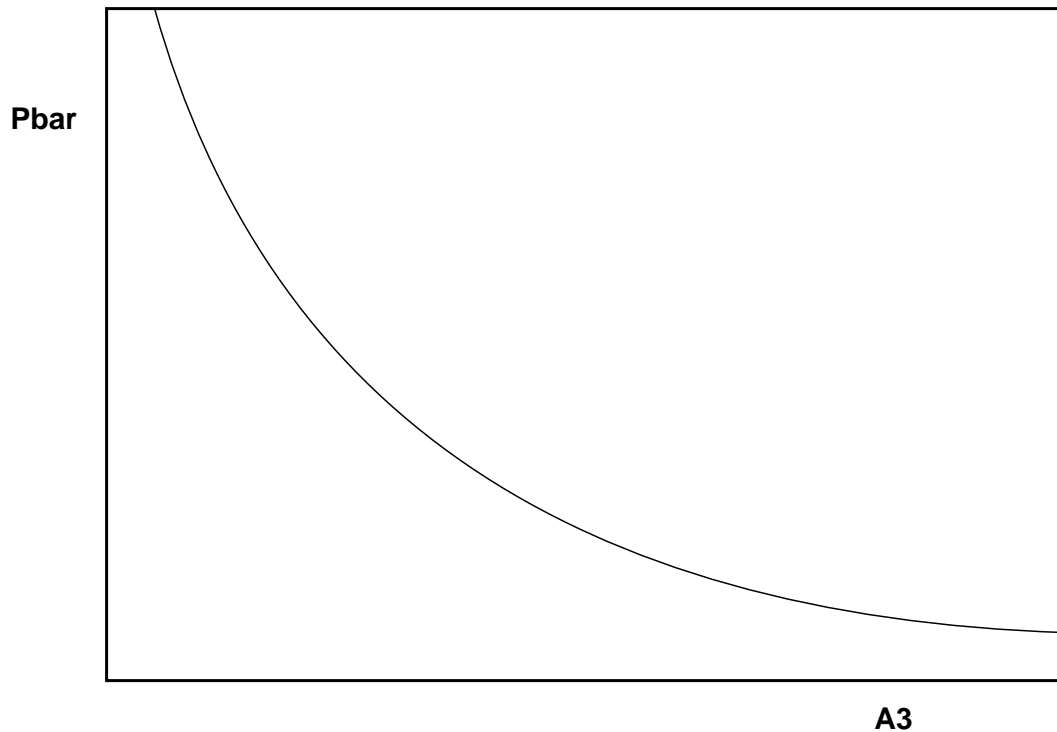

Figure 7.5: \bar{P} as A_1 to be relocated

Figure 7.6: \bar{P} as A_3 to be relocated

7.3.2 Are the trends reasonable?

Now second part, are the trends predicted by the “common” model are resumable (correct)? To examine that, we vary the plunger diameter, (A_1 or D_1) and the gate area, A_3 to see if any violation of the physics laws occurs as results. The comparison between the real trends and the “common” trends is discussed in the following section.

Plunger area/diameter variation

First, the effect of plunger diameter size variation is examined. In section 7.2 it was shown that $P_{max} \propto 1/D_1^2$. Equation (7.8) demonstrates that P_1 increases with an increase of P_{max} ⁸.

The value P_{max} can attained is an infinite value (according to the “common” model) therefore P_1 is infinite as well. The gate velocity, U_3 , increases as the plunger diameter decreases as shown in Figure 7.7. Armed with this knowledge now, several cases can be examined if the

⁸It also demonstrates that the value of \bar{P} never can exceed

$$\left[\frac{P_1}{P_{max}} \right]_{max} = \frac{\rho}{2} \left(\frac{Q_{max}}{C_D A_3} \right)^2 \quad (7.14)$$

Section 7.3. The validity of the “common” diagram

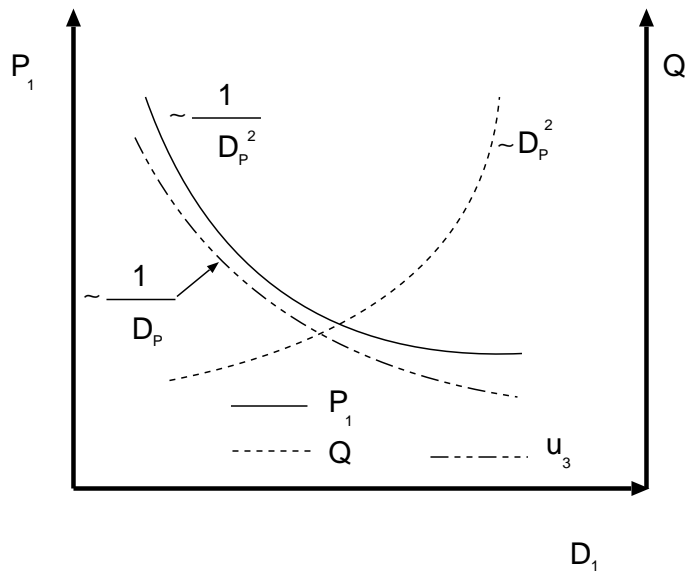

Figure 7.7: pressure at the plunger tip, P_1 , the flow rate, Q , and the gate velocity, U_3 as a function of plunger diameter, A_1

trends are realistic.

Gate area variation

Energy conservation (power supply machine characteristic) Let's assume that mass conservation is fulfilled, and, hence the plunger velocity can approach infinity, $U_1 \rightarrow \infty$ when $D_1 \rightarrow 0$ (under constant Q_{max}). The hydraulic piston also has to move with the same velocity, U_1 . Yet, according to the machine characteristic the driving pressure, approaches zero ($P_{B1} - P_{B2}) \rightarrow 0$. Therefore, the energy supply to the system is approaching zero. Yet, energy obtained from the system is infinite since jet is inject in infinite velocity and finite flow rate. This cannot exist in our world or perhaps one can proof the opposite.

Energy conservation (power supply) Assuming that the mass balance requirement is obtained, the pressure at plunger tip, P_1 and gate velocity, U_3 , increase (and can reach infinity, (when $P_1 \rightarrow \infty$ then $U_3 \rightarrow \infty$) when the plunger diameter is reduced. Therefore, the energy supply to the system has to be infinity (assuming a constant energy dissipation, actually the dissipation increases with plunger diameter in most ranges) However, the energy supply to the system (c.v. only the liquid metal) system would be $P_{B1}A_{B1}U_1$ (finite amount) and the energy the system provide plus would be infinity (infinite gate velocity) plus dissipation.

to make a question in regards to dissipation and velocity

Energy conservation (dissipation problem) A different way to look at this situation is check what happen to physical quantities. For example, the resistance to the liquid metal flow increases when the gate velocity velocity is increased. As smaller the plunger diameter the

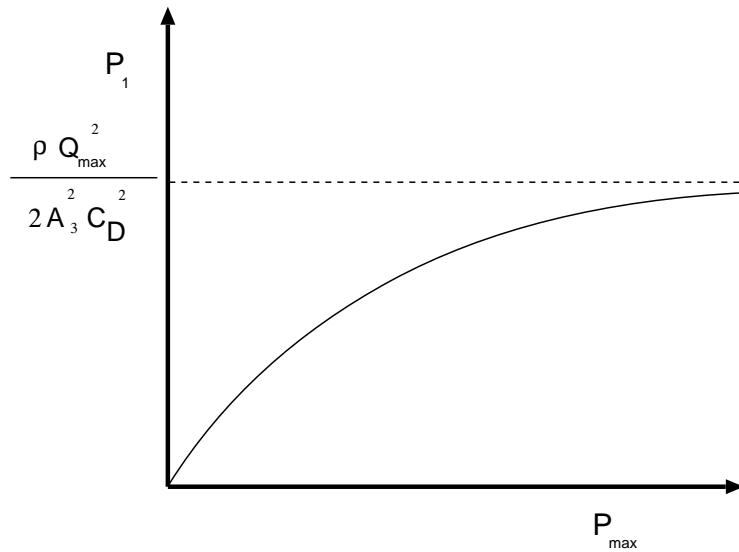

Figure 7.8: P_1 as a function of P_{max}

larger the gate velocity and the larger the resistance. However, the energy supply to the system has a maximum ability. Hence, this trend from this respect is unrealistic.

Mass conservation (strike) According to the “common” model, the gate velocity decreases when the plunger diameter increases. Conversely, the gate velocity increases when the plunger diameter decreases⁹. According to equation (7.2) the liquid metal flow rate at the gate increases as well. However, according to the “common” pQ^2 diagram, the plunger can move only in a finite velocity lets say in the extreme case U_{max} ¹⁰. Therefore, the flow rate at the plunger tip decreases. Clearly, these diametrically opposing trends cannot coexist. Either the “common” pQ^2 diagram wrong or the mass balance concept is wrong, take your pick.

Mass conservation (hydraulic pump): The mass balance also has to exist in hydraulic pump (obviously). If the plunger velocity have to be infinite to maintain mass balance in the metal side, the mass flow rate at the hydraulic side of the rode also have to be infinite. However, the pump has maximum capacity for flow rate. Hence, mass balance can be obtained.

to put table with different trends as a function of A_3 and may be with a figure.

7.3.3 Variations of the Gate area, A_3

under construction

⁹check again Figure 7.4

¹⁰this is the velocity attained when the shot sleeve is empty

7.4 The reformed pQ^2 diagram

The method based on the liquid metal properties is with disagreement with commonly agreed on in fluid mechanics (Pao1961, pp. 235-299). It is commonly agreed that C_D is a function of Reynolds number and the geometry of the runner design. The author (Bar-Meir and Winkler1994) suggested adopting an approach where the C_D is calculated by utilizing data of flow resistance of various parts (segments) of the runner. The available data in the literature demonstrates that a typical value of C_D can change as much as 100% or more just by changing the gate area (like valve opening). Thus, the assumption of a constant C_D , which is used in "common" pQ^2 calculations¹¹, is not valid. Here a systematic derivation of the pQ^2 diagram is given. The approach adapted in this book is that everything (if possible) should be presented in dimensionless form.

7.4.1 The reform model

Equation (7.1) can be transformed into dimensionless from as

$$\bar{Q} = \sqrt{1 - \bar{P}} \quad (7.15)$$

Where:

\bar{P} reduced pressure, P_1/P_{max}
 \bar{Q} reduced flow rate, Q_1/Q_{max}

Eckert (Eckert1989) also demonstrated that the gravity effects are negligible¹². Assuming steady state¹³ and utilizing Bernoulli's equation between point (1) on plunger tip and point (3) at the gate area (see Figure 7.1) yields

$$\frac{P_1}{\rho} + \frac{U_1^2}{2} = \frac{P_3}{\rho} + \frac{U_3^2}{2} + h_{1,3} \quad (7.16)$$

where:

U velocity of the liquid metal
 ρ the liquid metal density
 $h_{1,3}$ energy loss between plunger tip and gate exit
 subscript
 1 plunger tip
 2 entrance to runner system
 3 gate

It has been shown that the pressure in the cavity can be assumed to be about atmospheric (for air venting or vacuum venting) providing vents are properly designed Bar-Meir at el (Bar-Meir, Eckert and Goldstein1996; Bar-Meir, Eckert and Goldstein1997)¹⁴. This assumption is

¹¹or as it is suggested by the referee II

¹²see for more details chapter 3

¹³read in the section 7.4.4 on the transition period of the pQ^2

¹⁴Read a more detailed discussion in Chapter 9

not valid when the vents are poorly designed. When they are poorly designed, the ratio of the vent area to critical vent area determines the build up pressure, P_3 , which can be calculated as it is done in Bar–Meir et al (Bar–Meir, Eckert and Goldstein1997). However, this is not a desirable situation since a considerable gas/air porosity is created and should be avoided. It also has been shown that the chemical reactions do not play a significant role during the filling of the cavity and can be neglected (Bar–Meir1995b).

The resistance in the mold to liquid metal flow depends on the geometry of the part to be produced. If this resistance is significant, it has to be taken into account calculating the total resistance in the runner. In many geometries, the liquid metal path in the mold is short, then the resistance is insignificant compared to the resistance in the runner and can be ignored. Hence, the pressure at the gate, P_3 , can be neglected. Thus, equation (7.16) is reduced to

$$\frac{P_1}{\rho} + \frac{U_1^2}{2} = \frac{U_3^2}{2} + h_{1,3} \quad (7.17)$$

The energy loss, $h_{1,3}$, can be expressed in terms of the gate velocity as

$$h_{1,3} = K_F \frac{U_3^2}{2} \quad (7.18)$$

where K_F is the resistance coefficient, representing a specific runner design and specific gate area.

Combining equations (7.7), (7.17) and (7.18) and rearranging yields

$$U_3 = C_D \sqrt{\frac{2P_1}{\rho}} \quad (7.19)$$

where

$$C_D = f(A_3, A_1) = \sqrt{\frac{1}{1 - \left(\frac{A_3}{A_1}\right)^2 + K_F}} \quad (7.20)$$

Converting equation (7.19) into a dimensionless form yields

$$\bar{Q} = \sqrt{2Oz\bar{P}} \quad (7.21)$$

When the Ozer Number is defined as

$$Oz = \frac{\frac{C_D^2 P_{max}}{\rho}}{\left(\frac{Q_{max}}{A_3}\right)^2} = \left(\frac{A_3}{Q_{max}}\right)^2 C_D^2 \frac{P_{max}}{\rho} \quad (7.22)$$

The significance of the Oz number is that this is the ratio of the "effective" maximum energy of the hydrostatic pressure to the maximum kinetic energy. Note that the Ozer number is not a parameter that can be calculated a priori since the C_D is varying with the operation point.

¹⁵ For practical reasons the gate area, A_3 cannot be extremely large. On the other hand, the gate area can be relatively small $A_3 \sim 0$ in this case Ozer number $A_3 A_3^n$ where n is a number larger than 2 ($n > 2$).

¹⁵It should be margin-note and so please ignore this footnote.

Section 7.4. The reformed pQ^2 diagram

Solving equations (7.21) with (7.15) for \bar{P} , and taking only the possible physical solution, yields

$$\bar{P} = \frac{1}{1 + 2 Oz} \quad (7.23)$$

which is the dimensionless form of equation (7.8).

7.4.2 Examining the solution

This solution provide a powerful tool to examine various parameters and their effects on the design. The important factors that every engineer has to find from these calculations are: gate area, plunger diameters, the machine size, and machine performance etc¹⁶. These issues are explored further in the following sections.

The gate area effects

Gate area affects the reduced pressure, \bar{P} , in two ways: via the Ozer number which include two terms: one, (A_3/Q_{max}) and, two, discharge coefficient C_D . The discharge coefficient, C_D is also affected by the gate area affects through two different terms in the definition (equation 7.20), one, $(A_3/A_1)^2$ and two by K_F .

Q_{max} effect is almost invariant with respect to the gate area up to small gate area sizes¹⁷. Hence this part is somewhat clear and no discussion is need.

perhaps to put discussion pending on the readers response.

$(A_3/A_1)^2$ effects Lets look at at the definition of C_D equation (7.20). For illustration purposes let assume that K_F is not a function of gate area, $K_F(A_3) = const$. A small perturbation of the gate area results in Taylor series,

$$\begin{aligned} \Delta C_D &= C_D(A_3 + \Delta A_3) - C_D(A_3) & (7.24) \\ &= \frac{1}{\sqrt{1 - \frac{A_3^2}{A_1^2} + K_F}} + \frac{A_3 \Delta A_3}{A_1^2 \left(1 - \frac{A_3^2}{A_1^2} + K_F\right)^{\frac{3}{2}}} + \\ &\quad \left(\frac{3 A_3^2}{A_1^4 \left(1 - \frac{A_3^2}{A_1^2} + K_F\right)^2} + \frac{1}{A_1^2 \left(1 - \frac{A_3^2}{A_1^2} + K_F\right)} \right) \Delta A_3^2 \\ &\quad \frac{2 \sqrt{1 - \frac{A_3^2}{A_1^2} + K_F}}{2 \sqrt{1 - \frac{A_3^2}{A_1^2} + K_F}} + O(\Delta A_3)^3 \end{aligned}$$

how Ozer number behaves as a function of the gate area?

$$Oz = \frac{P_{max}}{\rho Q_{max}^2} \frac{A_3}{1 - \left(\frac{A_3}{A_1}\right)^2 + K_F}$$

¹⁶The machine size also limited by a second parameter known as the clamping forces to be discussed in Chapter 10

¹⁷This is reasonable speculation about this point. More study is well come

In this case equation (7.8) still hold but C_D has to be reevaluated.

Example 7.5

repeat the example 7.2 with $K_F = 3.3$

Solution

First calculate the discharge coefficient, C_D for various gate area starting from $2.4 \cdot 10^{-6} [m^2]$ to $3 \cdot 10^{-4} [m^2]$ using equation 7.20.

This example demonstrate the very limited importance of the inclusion of the term $(A_3/A_1)^2$ into the calculations.

K_F effects The change in the gate area increases the resistance to the flow via several contributing factors which include: the change in the flow cross section, change in the direction of the flow, frictional loss due to flow through the gate length, and the loss due to the abrupt expansion after the gate. The loss due to the abrupt expansion is a major contributor and its value changes during the filling process. The liquid metal enters the mold cavity in the initial stage as a “free jet” and sometime later it turns into an immersed jet which happens in many geometries within 5%-20% of the filling. The change in the flow pattern is believed to be gradual and is a function of the mold geometry. A geometry with many changes in the direction of the flow and/or a narrow mold (relatively thin walls) will have the change to immersed jet earlier. Many sources provide information on K_F for various parts of the designs of the runner and gate. Utilizing this information produces the gate velocity as a function of the given geometry. To study further this point consider a case where K_F is a simple function of the gate area. When A_3 is very large then the effect on K_F are relatively small. Conversely,

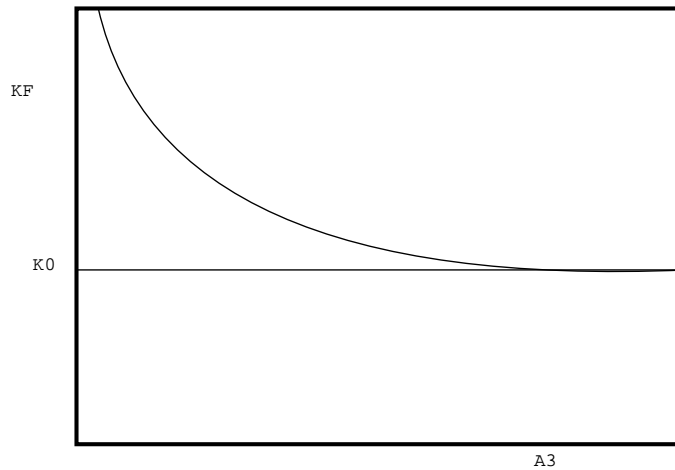

Figure 7.9: K_F as a function of gate area, A_3

when $A_3 \rightarrow 0$ the resistance, $K_F \rightarrow \infty$. The simplest function, shown in Figure 7.9, that represent such behavior is

$$K_F = C_1 + \frac{C_2}{A_3} \tag{7.25}$$

Section 7.4. The reformed pQ^2 diagram

C_1 and C_2 are constants and can be calculated (approximated) for a specific geometry. The value of C_1 determine the value of the resistance where A_3 effect is minimum and C_2 determine the range (point) where A_3 plays a significant effect. In practical, it is found that C_2 is in the range where gate area are desired and therefore program such as DiePerfect™ are important to calculated the actual resistance.

Example 7.6

Under construction

create a question with respect to the function 7.25

Solution

Under construction

The combined effects Consequently, a very small area ratio results in a very large resistance, and when $\frac{A_3}{A_1} \rightarrow 0$ therefore the resistance $\rightarrow \infty$ resulting in a zero gate velocity (like a closed valve). Conversely, for a large area ratio, the resistance is insensitive to variations of the gate area and the velocity is reduced with increase the gate area. Therefore a maximum gate velocity must exist, and can be found by

$$\frac{dU_3}{dA_3} = 0 \quad (7.26)$$

which can be solved numerically. The solution of equation (7.26) requires full information on the die casting machine.

A general complicated runner design configuration can be converted into a straight conduit with trapezoidal cross-section, provided that it was proportionally designed to create equal gate velocity for different gate locations¹⁸. The trapezoidal shape is commonly used because of the simplicity, thermal, and for cost reasons.

leave it for now, better presentation needed

Example 7.7

To illustrate only the effects of the gate area change two examples are presented: one, a constant pressure is applied to the runner, two, a constant power is applied to the runner. The resistance to the flow in the shot sleeve is small compared to resistance in the runner, hence, the resistance in the shot sleeve can be neglected. The die casting machine performance characteristics are isolated, and the gate area effects on the the gate velocity can be examined. Typical dimensions of the design are presented in Figure 7.10. The short conduit of 0.25[m] represents an excellent runner design and the longest conduit of 1.50[m] represents a very poor design. The calculations were carried for aluminum alloy with a density of 2385[kg/m³] and a kinematic viscosity of 0.544 × 10⁻⁶[m²/sec] and runner surface roughness of 0.01 [mm]. For the constant pressure case the liquid metal pressure at the runner entrance is assumed to be 1.2[MPa] and for the constant power case the power loss is [1Kw].

¹⁸read about poor design effect on pQ^2 diagram

Solution

The gate velocity is exhibited as a function of the ratio of the gate area to the conduit area as shown in Figure 7.11 for a constant pressure and in Figure 7.12 for a constant power.

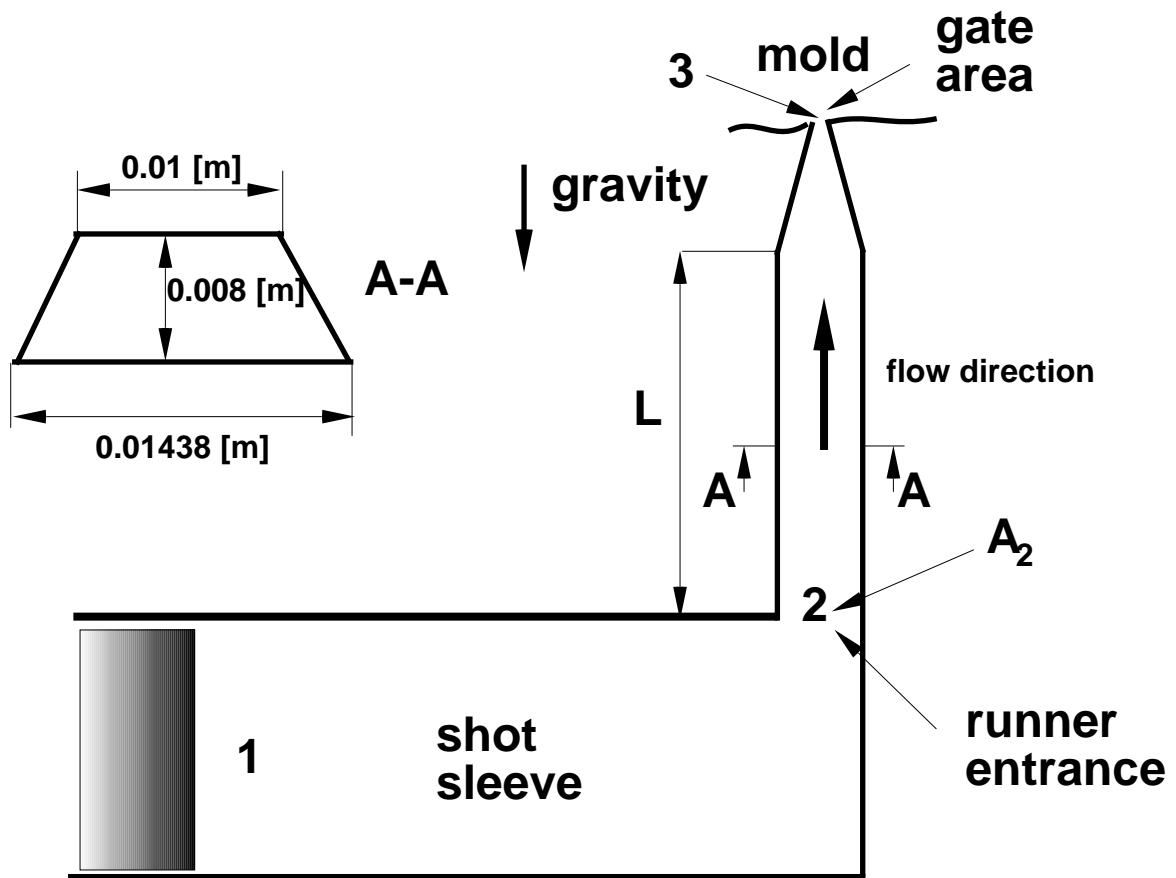

Figure 7.10: Design and dimensions of the runner for the example 7.4.2. The length, L , represents different runner design qualities. The gate design is made of straight lines to the gate area, creating a symmetrical gate.

Figure 7.11: Gate velocities as a function of the area ratio for constant pressure.

Figure 7.12: Gate velocities as a function of the area ratio for constant power.

General conclusions from example 7.4.2

For the constant pressure case the “common”¹⁹ assumption yields a constant velocity even for a zero gate area.

The solid line in Figure 7.11 represents the gate velocity calculated based on the common assumption of constant C_D while the other lines are based on calculations which take into account the runner geometry and the Re number. The results for constant C_D represent “averaged” of the other results. The calculations of the velocity based on a constant C_D value are unrealistic. It overestimates the velocity for large gate area and underestimates for the area ratio below $\sim 80\%$ for the short runner and 35% for the long runner. Figure 7.11 exhibits that there is a clear maximum gate velocity which depends on the runner design (here represented by the conduit length). The maximum indicates that the preferred situation is to be on the “right hand side branch” because of shorter filling time. The gate velocity is doubled for the excellent design compared with the gate velocity obtained from the poor design. This indicates that the runner design is more important than the specific characteristic of the die casting machine performance. Operating the die casting machine in the “right hand side” results in smaller requirements on the die casting machine because of a smaller filling time, and therefore will require a smaller die casting machine.

For the constant power case, the gate velocity as a function of the area ratio is shown in Figure 7.12. The common assumption of constant C_D yields the gate velocity $U_3 \propto A_1/A_3$ shown by the solid line. Again, the common assumption produces unrealistic results, with the gate velocity approaching infinity as the area ratio approaches zero. Obviously, the results with a constant C_D overestimates the gate velocity for large area ratios and underestimates it for small area ratios. The other lines describe the calculated gate velocity based on the runner geometry. As before, a clear maximum can also be observed. For large area ratios, the gate velocity with an excellent design is almost doubled compared to the values obtained with a poor design. However, when the area ratio approaches zero, the gate velocity is insensitive to the runner length and attains a maximum value at almost the same point.

In conclusion, this part has been shown that the use of the “common” pQ^2 diagram with the assumption of a constant C_D may lead to very serious errors. Using the pQ^2 diagram, the engineer has to take into account the effects of the variation of the gate area on the discharge coefficient, C_D , value. The two examples given in here do not represent the characteristics of the die casting machine. However, more detailed calculations shows that the constant pressure is in control when the plunger is small compared to the other machine dimensions and when the runner system is very poorly designed. Otherwise, the combination of the pressure and power limitations results in the characteristics of the die casting machine which has to be solved.

¹⁹As it is written in NADCA's books

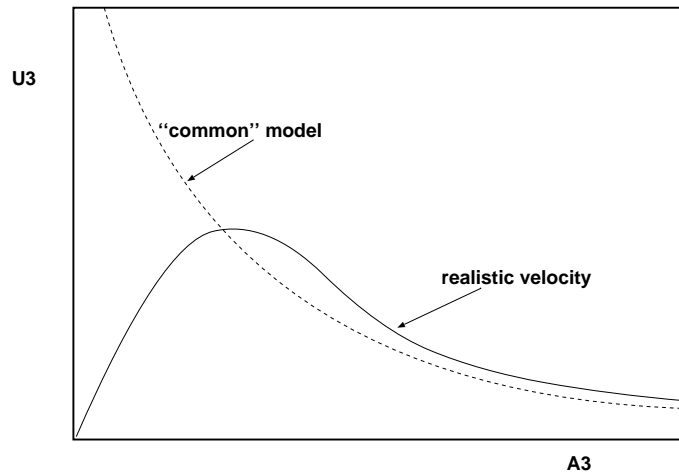
Figure 7.13: U_3 as a function of gate area, A_3

The die casting machine characteristic effects

There are two type of operation of the die casting machine, one) the die machine is operated directly by hydraulic pump (mostly on the old machines). two) utilizing the non continuous demand for the power, the power is stored in a container and released when need (mostly on the newer machines). The container is normally a large tank contain nitrogen and hydraulic liquid²⁰. The effects of the tank size and gas/liquid ratio on the pressure and flow rate can easily be derived.

Meta The power supply from the tank with can consider almost as a constant pressure but the line to actuator is with variable resistance which is a function of the liquid velocity. The resistance can be consider, for a certain range, as a linear function of the velocity square, " U_B^2 ". Hence, the famous a assumption of the "common" die casting machine $p \propto Q^2$.

End

The characteristic of the various pumps have been studied extensively in the past (Fairbanks1959). The die casting machine is a pump with some improvements which are patented by different manufactures. The new configurations, such as double pushing cylinders, change somewhat the characteristics of the die casting machines. First let discuss some general characteristic of a pump (issues like empelor, speed are out of the scope of this discussion). A pump is mechanical devise that transfers and electrical power (mostly) into "hydraulic" power. A typical characteristic of a pump are described in Figure 7.14.

insert the discussion about pump characteristic with the figure from the red folder notes

²⁰This similar to operation of water system in a ship, many of the characteristics are the same. Furthermore, the same differential equations are governing the situation. The typical questions such as the necessarily container size and the ratio of gas to hydraulic liquid were part of my study in high school (probably the simplified version of the real case). If demand to this material raised, I will insert it here in the future.

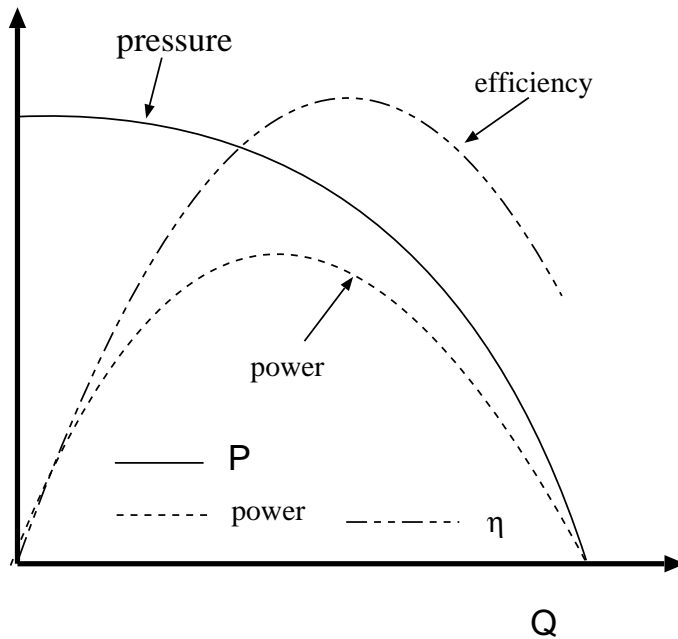

Figure 7.14: General characteristic of a pump

Two similar pumps can be connect in two way series and parallel. The parallel connection increase mostly the flow rate as shown in Figure 7.14. The serious connection increase mostly the pressure as shown in Figure 7.14. The series connection if "normalized" is very close to the original pump. However, the parallel connection when "normalized" show a better performance.

To study the effects of the die casting machine performances, the following functions are examined (see Figure 7.15):

$$\bar{Q} = 1 - \bar{P} \quad (7.27a)$$

$$\bar{Q} = \sqrt{1 - \bar{P}} \quad (7.27b)$$

$$\bar{Q} = \sqrt[4]{1 - \bar{P}} \quad (7.27c)$$

The functions (7.27a), (7.27b) and (7.27c) represent a die casting machine with a poor performance, the common performance, and a die casting machine with an excellent performance, respectively.

Combining equation (7.21) with (7.27) yields

$$1 - \bar{P} = \sqrt{2Oz\bar{P}} \quad (7.28a)$$

$$\sqrt{1 - \bar{P}} = \sqrt{2Oz\bar{P}} \quad (7.28b)$$

$$\sqrt[4]{1 - \bar{P}} = \sqrt{2Oz\bar{P}} \quad (7.28c)$$

rearranging equation (7.28) yields

$$\bar{P}^2 - 2(1 + Oz)\bar{P} + 1 = 0 \quad (7.29a)$$

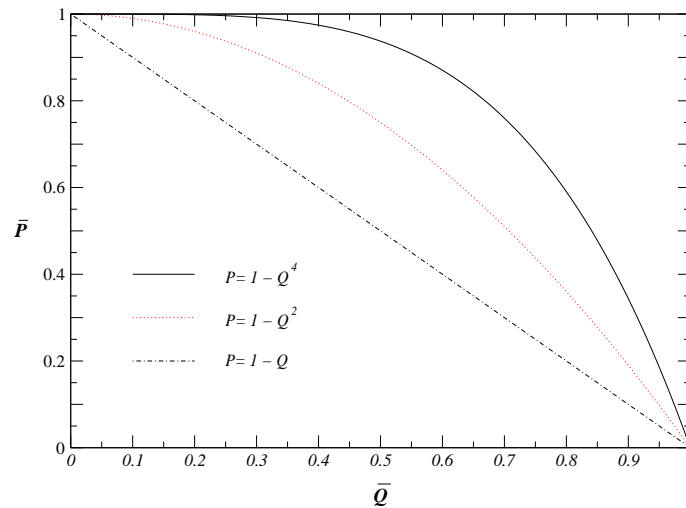

Figure 7.15: Various die casting machine performances

$$1 - \bar{P}(1 + 2Oz) = 0 \tag{7.29b}$$

$$4Oz\bar{P}^2 + \bar{P} - 1 = 0 \tag{7.29c}$$

Solving equations (7.29) for \bar{P} , and taking only the possible physical solution, yields

$$\bar{P} = 1 + Oz - \sqrt{(2 + Oz)Oz} \tag{7.30a}$$

$$\bar{P} = \frac{1}{1 + 2Oz} \tag{7.30b}$$

$$\bar{P} = \frac{\sqrt{1 + 16Oz^2} - 1}{8Oz^2} \tag{7.30c}$$

The reduced pressure, \bar{P} , is plotted as a function of the Oz number for the three die casting machine performances as shown in Figure 7.16.

Figure 7.16: Reduced pressure, \bar{P} , for various machine performances as a function of the Oz number

Figure 7.16 demonstrates that \bar{P} monotonically decreases with an increase in the Oz number for all the machine performances. All the three results convert to the same line which is a plateau after $Oz = 20$. For large Oz numbers the reduced pressure, \bar{P} , can be considered to be constant $\bar{P} \simeq 0.025$. The gate velocity, in this case, is

$$U_3 \simeq 0.22C_D \sqrt{\frac{P_{max}}{\rho}} \tag{7.31}$$

The Ozer number strongly depends on the discharge coefficient, C_D , and P_{max} . The value of Q_{max} is relatively insensitive to the size of the die casting machine. Thus, this equation

Section 7.4. The reformed pQ^2 diagram

is applicable to a well designed runner (large C_D) and/or a large die casting machine (large P_{max}).

The reduced pressure for a very small value of the Oz number equals to one, $\bar{P} \simeq 1$ or $P_{max} = P_1$, due to the large resistance in the runner (when the resistance in the runner approaches infinity, $K_F \rightarrow \infty$, then $\bar{P} = 1$). Hence, the gate velocity is determined by the approximation of

$$U_3 \simeq C_D \sqrt{\frac{2P_{max}}{\rho}} \quad (7.32)$$

The difference between the various machine performances is more considerable in the middle range of the Oz numbers. A better machine performance produces a higher reduced pressure, \bar{P} . The preferred situation is when the Oz number is large and thus indicates that the machine performance is less important than the runner design parameters. This observation is further elucidated in view of Figures 7.11 and 7.12.

Plunger area/diameter effects

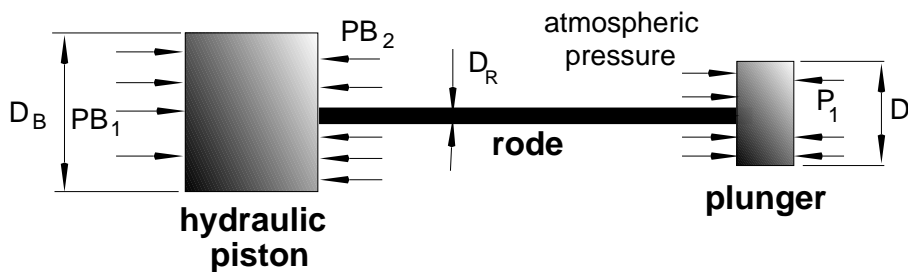

explain what we trying to achieve here

Figure 7.17: Schematic of the plunger and piston balance forces

The pressure at the plunger tip can be evaluated from a balance forces acts on the hydraulic piston and plunger as shown in Figure 7.17. The atmospheric pressure that acting on the left side of the plunger is neglected. Assuming a steady state and neglecting the friction, the forces balance on the rod yields

$$\frac{D_B^2 \pi}{4} (P_{B1} - P_{B2}) + \frac{D_R^2 \pi}{4} P_{B2} = \frac{D_1^2 \pi}{4} P_1 \quad (7.33)$$

In particular, in the stationary case the maximum pressure obtains

$$\frac{D_B^2 \pi}{4} (P_{B1} - P_{B2})|_{max} + \frac{D_R^2 \pi}{4} P_{B2}|_{max} = \frac{D_1^2 \pi}{4} P_1|_{max} \quad (7.34)$$

The equation (7.34) is reduced when the rode area is negligible; plus, notice that $P_1|_{max} = P_{max}$ to read

$$\frac{D_B^2 \pi}{4} (P_{B1} - P_{B2})|_{max} = \frac{D_1^2 \pi}{4} P_{max} \quad (7.35)$$

(why? perhaps to create a question for the students)

Figure 7.18: Reduced liquid metal pressure at the plunger tip and reduced gate velocity as a function of the reduced plunger diameter

Rearranging equation (7.35) yields

$$\left(\frac{D_B}{D_1}\right)^2 = \frac{P_{max}}{(P_{B1} - P_{B2})|_{max}} \Rightarrow P_{max} = (P_{B1} - P_{B2})|_{max} \left(\frac{D_B}{D_1}\right)^2 \quad (7.36)$$

21

The gate velocity relates to the liquid metal pressure at plunger tip according to the following equation combining equation (7.5) and (7.30b) yields

$$U_3 = C_D \sqrt{\frac{2}{\rho}} \sqrt{\frac{(P_{B1} - P_{B2})|_{max} \left(\frac{D_B}{D_1}\right)^2}{1 + \frac{2}{\rho} \left(\frac{C_D A_3}{Q_{max}}\right)^2 (P_{B1} - P_{B2})|_{max} \left(\frac{D_B}{D_1}\right)^2}} \quad (7.37)$$

perhaps, discuss $\frac{d\bar{P}}{dA_1}$

Under the assumption that the machine characteristic is $P_1 \propto \bar{Q}^2 \Rightarrow \bar{P} = 1 - \bar{Q}^2$,

Meta the solution for the intersection point is given by equation ? To study equation (7.37), let's define

$$\chi = \sqrt{\frac{\rho}{(P_{B1} - P_{B2})|_{max}}} \left[\frac{Q_{max}}{C_D A_3} \right] \left[\frac{D_1}{D_B} \right] \quad (7.38)$$

and the reduced gate velocity

$$y = \frac{U_3 A_3}{Q_{max}} \quad (7.39)$$

Using these definitions, equation (7.37) is converted to a simpler form:

$$y = \sqrt{\frac{1}{\chi^2 + 1}} \quad (7.40)$$

²¹Note that $P_1|_{max} \neq [P_1]_{max}$. The difference is that $P_1|_{max}$ represents the maximum pressure of the liquid metal at plunger tip in the stationary case, where as $[P_1]_{max}$ represents the value of the maximum pressure of the liquid metal at the plunger tip that can be achieved when hydraulic pressure within the piston is varied. The former represents only the die casting machine and the shot sleeve, while the latter represents the combination of the die casting machine (and shot sleeve) and the runner system.

Equation (7.14) demonstrates that the value of $[P_1]_{max}$ is independent of P_{max} (for large values of P_{max}) under the assumptions in which this equation was attained (the "common" die casting machine performance, etc). This suggests that a smaller die casting machine can achieve the same job assuming average performance die casing machine.

Section 7.4. The reformed pQ^2 diagram

With these definitions, and denoting

$$\eta = P_1 \frac{2}{\rho} \left(\frac{C_D A_3}{Q_{max}} \right)^2 = 2 Oz \bar{P} \quad (7.41)$$

one can obtain from equation (7.30b) that (make a question about how to do it?)

$$\eta = \frac{1}{\chi^2 + 1} \quad (7.42)$$

The coefficients of P_1 in equation (7.41) and D_1 in equation (7.38) are assumed constant according to the “common” pQ^2 diagram. Thus, the plot of y and η as a function of χ represent the affect of the plunger diameter on the reduced gate velocity and reduced pressure. The gate velocity and the liquid metal pressure at plunger tip decreases with an increase in the plunger diameters, as shown in Figure 7.18 according to equations (7.40) and (7.42).

End

more discussion on the meaning of the results

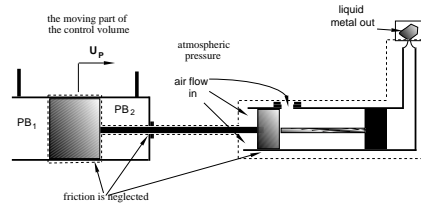

Figure 7.19: A general schematic of the control volume of the hydraulic piston with the plunger and part of the liquid metal

A control volume as it is shown in Figure 7.19 is constructed to study the effect of the plunger diameter, (which includes the plunger with the rode, hydraulic piston, and shot sleeve, but which does not include the hydraulic liquid or the liquid metal jet). The control volume is stationary around the shot sleeve and is moving with the hydraulic piston. Applying the first law of thermodynamics, when that the atmospheric pressure is assumed negligible and neglecting the dissipation energy, yields

$$\dot{Q} + \dot{m}_{in} \left(h_{in} + \frac{U_{in}^2}{2} \right) = \dot{m}_{out} \left(h_{out} + \frac{U_{out}^2}{2} \right) + \left. \frac{dm}{dt} \right|_{c.v.} \left(e + \frac{U_{c.v.}^2}{2} \right) + \dot{W}_{c.v.} \quad (7.43)$$

why? should be included in the end.

In writing equation (7.43), it should be noticed that the only change in the control volume is in the shot sleeve. The heat transfer can be neglected, since the filling process is very rapid. There is no flow into the control volume (neglecting the air flow into the back side of the plunger and the change of kinetic energy of the air, why?), and therefore the second term on the right hand side can be omitted. Applying mass conservation on the control volume for the liquid metal yields

$$\left. \frac{dm}{dt} \right|_{c.v.} = -\dot{m}_{out} \quad (7.44)$$

The boundary work on the control volume is done by the left hand side of the plunger and can be expressed by

$$\dot{W}_{c.v.} = -(P_{B1} - P_{B2})A_B U_1 \quad (7.45)$$

The mass flow rate out can be related to the gate velocity

$$\dot{m}_{out} = \rho A_3 U_3 \quad (7.46)$$

Mass conservation on the liquid metal in the shot sleeve and the runner yields

$$A_1 U_1 = A_3 U_3 \implies U_1^2 = U_3^2 \left(\frac{A_3}{A_1} \right)^2 \quad (7.47)$$

Substituting equations (7.44-7.47) into equation (7.43) yields

$$(P_{B1} - P_{B2})A_B U_3 A_1 = \rho A_3 U_3 \left[(h_{out} - e) + \frac{U_3^2}{2} \left(1 - \left(\frac{A_3}{A_1} \right)^2 \right) \right] \quad (7.48)$$

Rearranging equation (7.48) yields

$$(P_{B1} - P_{B2}) \frac{A_B}{A_1 \rho} = (h_{out} - e) + \frac{U_3^2}{2} \left(1 - \left(\frac{A_3}{A_1} \right)^2 \right) \quad (7.49)$$

Solving for U_3 yields

$$U_3 = \sqrt{\frac{2 \left[(P_{B1} - P_{B2}) \frac{A_B}{A_1 \rho} - (h_{out} - e) \right]}{\left[1 - \left(\frac{A_3}{A_1} \right)^2 \right]}} \quad (7.50)$$

Or in term of the maximum values of the hydraulic piston

$$U_3 = \sqrt{\frac{2 \left[\frac{(P_{B1} - P_{B2})|_{max}}{1+2Oz} \frac{A_B}{A_1 \rho} - (h_{out} - e) \right]}{\left[1 - \left(\frac{A_3}{A_1} \right)^2 \right]}} \quad (7.51)$$

When the term $(h_{out} - e)$ is neglected ($C_p \sim C_v$ for liquid metal)

$$U_3 = \sqrt{\frac{2 \frac{(P_{B1} - P_{B2})|_{max}}{1+2Oz} \frac{A_B}{A_1 \rho}}{\left[1 - \left(\frac{A_3}{A_1} \right)^2 \right]}} \quad (7.52)$$

Normalizing the gate velocity equation (7.52) yields

$$y = \frac{U_3 A_3}{Q_{max}} = \sqrt{\frac{C_D}{\chi^2 [1 + 2Oz] \left[1 - \left(\frac{A_3}{A_1} \right)^2 \right]}} \quad (7.53)$$

Section 7.4. The reformed pQ^2 diagram

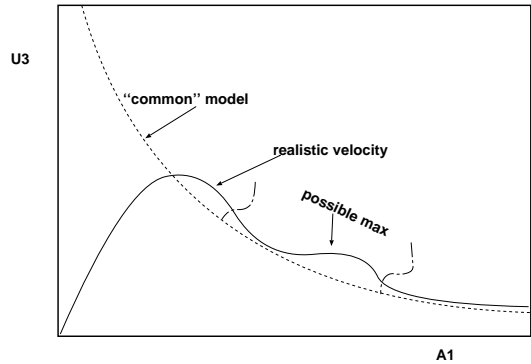

Figure 7.20: The gate velocity, U_3 as a function of the plunger area, A_1

Figure 7.21: The reduced power of the die casting machine as a function of the normalized flow rate

The expression (7.53) is a very complicated function of A_1 . It can be shown that when the plunger diameter approaches infinity, $D_1 \rightarrow \infty$ (or when $A_1 \rightarrow \infty$) then the gate velocity approaches $U_3 \rightarrow 0$. Conversely, the gate velocity, $U_3 \rightarrow 0$, when the plunger diameter, $D_1 \rightarrow 0$. This occurs because mostly $K \rightarrow \infty$ and $C_D \rightarrow 0$. Thus, there is at least one plunger diameter that creates maximum velocity (see figure 7.20). A more detailed study shows that depending on the physics in the situation, more than one local maximum can occur. With a small plunger diameter, the gate velocity approaches zero because C_D approaches infinity. For a large plunger diameter, the gate velocity approaches zero because the pressure difference acting on the runner is approaching zero. The mathematical expression for the maximum gate velocity takes several pages, and therefore is not shown here. However, for practical purposes, the maximum velocity can easily (relatively) be calculated by using a computer program such as DiePerfect™.

Machine size effect

The question how large the die casting machine depends on how efficient it is used. To maximize the utilization of the die casting machine we must understand under what condition it happens. It is important to realize that the injection of the liquid metal into the cavity requires power. The power, we can extract from a machine, depends on the plunger velocity and other parameters. We would like to design a process so that power extraction is maximized.

Let's define normalized machine size effect

$$\overline{P}_m = \frac{\overline{Q} \Delta P}{P_{max} \times Q_{max}} \simeq \overline{Q} \times \overline{P} \tag{7.54}$$

Every die casting machine has a characteristic curve on the pQ^2 diagram as well. Assuming that the die casting machine has the "common" characteristic, $\overline{P} = 1 - \overline{Q}^2$, the normalized

make for the three function of the machine characteristic as question.

power can be expressed

$$\overline{P}_m = \overline{Q}(1 - \overline{Q}^2) = \overline{Q}^2 - \overline{Q}^3 \quad (7.55)$$

where \overline{P}_m is the machine power normalized by $P_{max} \times Q_{max}$. The maximum power of this kind of machine is at 2/3 of the normalized flow rate, \overline{Q} , as shown in Figure 7.21. It is recommended to design the process so the flow rate occurs at the vicinity of the maximum of the power. For a range of 1/3 of \overline{Q} that is from $0.5\overline{Q}$ to $0.83\overline{Q}$, the average power is $0.1388 P_{max} Q_{max}$, as shown in Figure 7.21 by the shadowed rectangular. One may notice that this value is above the capability of the die casting machine in two ranges of the flow rate. The reason that this number is used is because with some improvements of the the runner design the job can be performed on this machine, and there is no need to move the job to a larger machine²².

Precondition effect (wave formation)

Meta discussion when $Q_1 \neq Q_3$

End

7.4.3 Poor design effects

Meta discussed the changes when different velocities are in different gates. Expanded on the sudden change to turbulent flow in one of the branches.

End

7.4.4 Transient effects

Under construction

To put the discussion about the inertia of the system and compressibility. the magnitude analysis before intensification effects

insert only general remarks until the paper will submitted for publication

insert the notes from the yellow folder

7.5 Design Process

Now with these pieces of information how one design the process/runner system. A design engineer in a local company have told me that he can draw very quickly the design for the mold and start doing the experiments until he gets the products running well. Well, the important part should not be how quickly you get it to try on your machine but rather how quickly you can produce a good quality product and how cheap (little scrap as possible and smaller die casting machine). Money is the most important factor in the production. This design process is longer than just drawing the runner and it requires some work. However, getting the production going is much more faster in most cases and cheaper (less design and undesign scrap and less

²²Assuming that requirements on the clamping force is meet.

Section 7.6. The Intensification Consideration

experiments/starting cost). Hence, for given die geometry, four conditions (actually there are more) need to be satisfied

$$\frac{\partial U_3}{\partial A_1} = 0 \quad (7.56)$$

$$\frac{\partial U_3}{\partial A_3} = 0 \quad (7.57)$$

the clamping force, and satisfy the power requirements.

For these criteria the designer has to check the runner design to see if gate velocity are around the recommended range. A possible answer has to come from financial considerations, since we are in the business of die casting to make money. Hence, the optimum diameter is the one which will cost the least (the minimum cost). How, then, does the plunger size determine cost? It has been shown that plunger diameter has a value where maximum gate velocity is created.

General relationship between runner hydraulic diameter and plunger diameter.

A very large diameter requires a very large die casting machine (due to physical size and the weight of the plunger). So, one has to choose as first approximation the largest plunger on a smallest die casting machine. Another factor has to be taken into consideration is the scrap created in the shot sleeve. Obviously, the liquid metal in the sleeve has to be the last place to solidify. This requires the biscuit to be of at least the same thickness as the runner.

$$T_{runner} = T_{biscuit} \quad (7.58)$$

Therefore, the scrap volume should be

$$\frac{\pi D_1^2}{4} T_{biscuit} \Rightarrow \frac{\pi D_1^2}{4} T_{runner} \quad (7.59)$$

When the scrap in the shot sleeve becomes significant, compared to scrap of the runner

$$\frac{\pi D_1^2}{4} T_{runner} = \bar{L} T_{runner} \quad (7.60)$$

Thus, the plunger diameter has to be in the range of

$$D_1 = \sqrt{\frac{4}{\pi} \bar{L}} \quad (7.61)$$

To discuss that the plunger diameter should not be used as varying the plunger diameter to determine the gate velocity

7.6 The Intensification Consideration

Intensification is a process in which pressure is increased making the liquid metal flows during the solidification process to ensure compensation for the solidification shrinkage of the liquid metal

put schematic figure of how it is done from the patent by die casting companies

(up to 20%). The intensification is applied by two methods: one) by applying additional pump, two) by increasing the area of the actuator (the multiplier method, or the prefill method)²³.

. The first method does not increase the intensification force to " P_{max} " by much. However, the second method, commonly used today in the industry, can increase considerably the ratio.

Meta Analysis of the forces demonstrates that as first approximation the plunger diameter does not contribute any additional force toward pushing the liquid metal.

End

why? to put discussion

A very small plunger diameter creates faster solidification, and therefore the actual force is reduced. Conversely, a very large plunger diameter creates a very small pressure for driving the liquid metal.

discuss the the resistance as a function of the diameter

7.7 Summary

In this chapter it has been shown that the "common" diagram is not valid and produces unrealistic trends therefore has no value what so ever²⁴. The reformed pQ² diagram was introduced. The mathematical theory/presentation based on established scientific principles was introduced. The effects of various important parameters was discussed. The method of designing the die casting process was discussed. The plunger diameter has a value for which the gate velocity has a maximum. For $D_1 \rightarrow 0$ gate velocity, $U_3 \rightarrow 0$ when $D_1 \rightarrow \infty$ the same happen $U_3 \rightarrow 0$. Thus, this maximum gate velocity determines whether an increase in the plunger diameter will result in an increase in the gate velocity or not. An alternative way has been proposed to determine the plunger diameter.

7.8 Questions

7.2 Prove that the maximum flow rate, Q_{max} is reduced and that $Q_{max} \propto 1/D_P^2$ (see Figure 7.4). if U_{max} is a constant

7.3.1 Derive equation 7.11. Start with machine characteristic equation (7.1)

7.3.1 Find the relationship between C_D and Ozer number that satisfy equation (7.13)

7.3.1 find the relationship between $\left[A_3 \sqrt{\frac{P_1}{P_{max} - P_1}} \right]$ and A_3

7.3.1 A_3 what other parameters that C_D depend on which do not provide the possibility $C_D = constant$?

²³A note for the manufactures, if you would like to have your system described here with its advantages, please drop me a line and I will discuss with you about the material that I need. I will not charge you any money.

²⁴Beside the historical value

CHAPTER 8

Critical Slow Plunger Velocity

Garber concluded that his model was not able to predict an acceptable value for critical velocity for fill percentages lower than 50% ...

Brevick, Ohio

Contents

8.1	Introduction	98
8.2	The “common” models	98
8.2.1	Garber’s model	98
8.2.2	Brevick’s Model	101
	The square shot sleeve	101
8.2.3	Brevick’s circular model	102
8.2.4	Miller’s square model	102
8.3	The validity of the “common” models	103
8.3.1	Garber’s model	103
8.3.2	Brevick’s models	103
	square model	103
	Improved Garber’s model	103
8.3.3	Miller’s model	103
8.3.4	EKK’s model (numerical model)	104
8.4	The Reformed Model	104
8.4.1	The reformed model	104
8.4.2	Design process	106
8.5	Summary	107
8.6	Questions	107

8.1 Introduction

This Chapter deals with the first stage of the injection in a cold chamber machine in which the desire (mostly) is to expel maximum air/gas from the shot sleeve. Porosity is a major production problem in which air/gas porosity constitutes a large portion. Minimization of Air Entrainment in the Shot Sleeve (AEES) is a prerequisite for reducing air/gas porosity. This can be achieved by moving the plunger at a specific speed also known as the critical slow plunger velocity. It happens that this issue is related to the hydraulic jump, which was discussed in the previous Chapters 5 (accidently? you thought!).

The “common” model, also known as Garber’s model, with its extensions made by Brevick¹, Miller², and EKK’s model are presented first here. The basic fundamental errors of these models are presented. Later, the reformed and “simple” model is described. It followed by the transient and poor design effects³. Afterwards, as usual questions are given at the end of the chapter.

8.2 The “common” models

In this section the “common” models are described. Since the “popular” model also known as Garber’s model never work (even by its own creator)⁴, several other models have appeared. These models are described here to have a clearer picture of what was in the pre Bar–Meir’s model. First, a description of Garber’s model is given later Brevick’s two models along with Miller’s model⁵ are described briefly. Lastly, the EKK’s numerical model is described.

8.2.1 Garber’s model

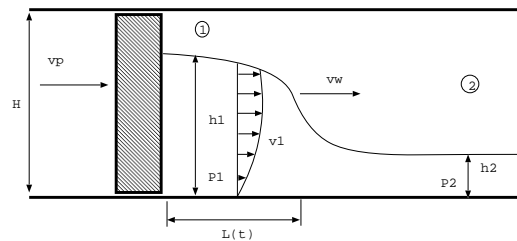

Figure 8.1: A schematic of wave formation in stationary coordinates

The description in this section is based on one of the most cited paper in the die casting research (Garber1982). Garber’s model deals only with a plug flow in a circular cross–section.

¹Industrial and Systems Engineering (ISE) Graduate Studies Chair, ISE department at The Ohio State University

²The chair of ISE Dept. at OSU

³It be added in the next addition

⁴I wonder if Garber and later Brevick have ever considered that their the models were simply totally false.

⁵This model was developed at Ohio State University by Miller’s Group in the early 1990’s.

Section 8.2. The “common” models

In this section, we “improve” the model to include any geometry cross section with any velocity profile⁶.

Consider a duct (any cross section) with a liquid at level h_2 and a plunger moving from the left to the right, as shown in Figure 8.1. Assuming a quasi steady flow is established after a very short period of time, a unique height, h_1 , and a unique wave velocity, V_w , for a given constant plunger velocity, V_p are created. The liquid in the substrate ahead of the wave is still, its height, h_2 , is determined by the initial fill. Once the height, h_1 , exceeds the height of the shot sleeve, H , there will be splashing. The splashing occurs because no equilibrium can be achieved (see Figure 8.2a). For h_1 smaller than H , a reflecting wave from the opposite wall appears resulting in an enhanced air entrainment (see Figure 8.2b). Thus, the preferred situation is when $h_1 = H$ (in circular shape $H = 2R$) in which case no splashing or a reflecting wave result.

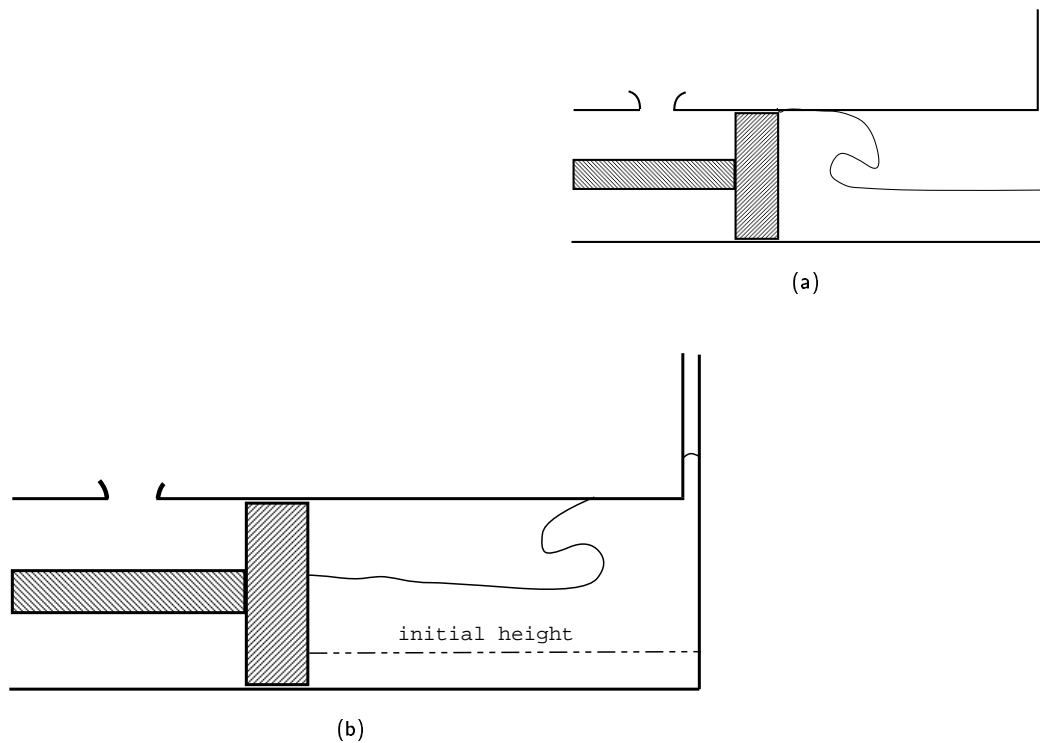

Figure 8.2: A schematic of reflecting wave formation in sub and super critical velocity

It is easier to model the wave with coordinates that move at the wave velocity, as shown in Figure 8.3. With the moving coordinate, the wave is stationary, the plunger moves back at

⁶This addition to the original Garber’s paper is derived here. I assumed that in this case, some mathematics will not hurt the presentation.

a velocity $(V_w - V_p)$, and the liquid moves from the right to the left. Dashed line shows the stationary control volume.

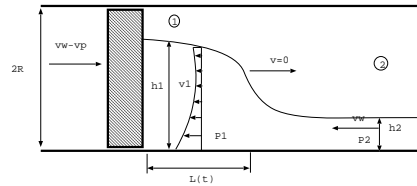

Figure 8.3: A schematic of the wave with moving coordinates

Mass conservation of the liquid in the control volume reads:

$$\int_{A_2} \rho V_w dA = \int_{A_1} \rho (v_1 - V_p) dA \quad (8.1)$$

where v_1 is the local velocity. Under quasi-steady conditions, the corresponding average velocity equals the plunger velocity:

$$\frac{1}{A_1} \int_{A_1} v_1 dA = \bar{v}_1 = V_p \quad (8.2)$$

Assuming that heat transfer can be neglected because of the short process duration⁷. Therefore, the liquid metal density (which is a function of temperature) can be assumed to be constant. Under the above assumptions, equation (8.1) can be simplified to

$$V_w A(h_2) = (V_w - V_p) A(h_1) \quad ; \quad A(h_i) = \int_0^{h_i} dA \quad (8.3)$$

Where i in this case can take the value of 1 or 2. Thus,

$$\frac{V_w}{(V_w - V_p)} = f(h_1, h_2) \quad (8.4)$$

where $f(h_1, h_2) = \frac{A(h_1)}{A(h_2)}$ is a dimensionless function. Equation (8.4) can be transformed into a dimensionless form:

$$f(h_1, h_2) = \frac{\tilde{v}}{(\tilde{v} - 1)} \quad (8.5a)$$

$$\Rightarrow \tilde{v} = \frac{f(h_1, h_2)}{f(h_1, h_2) - 1} \quad (8.5b)$$

where $\tilde{v} = \frac{V_w}{V_p}$. Assuming energy is conserved (the Garber's model assumption), and under conditions of negligible heat transfer, the energy conservation equation for the liquid in the control volume (see Figure 8.3) reads:

$$\int_{A_1} \left[\frac{P_B}{\rho} + \frac{\gamma_{1\epsilon} (V_w - V_p)^2}{2} \right] (V_w - V_p) dA = \int_{A_2} \left[\frac{P_2}{\rho} + \frac{V_w^2}{2} \right] V_w dA \quad (8.6)$$

⁷see Chapter 3 for a detailed discussion

build a question about what happens if the temperature changes by a few degrees. How much will it affect equation 8.2 and other parameters?

where

$$\gamma_{1\epsilon} = \frac{1}{A_1(V_w - V_p)^3} \int_{A_1} (V_w - v_1)^3 dA = \frac{1}{A_1(\tilde{v} - 1)^3} \int_{A_1} \left(\tilde{v} - \frac{v_1}{V_p} \right)^3 dA \quad (8.7)$$

The shape factor, $\gamma_{1\epsilon}$, is introduced to account for possible deviations of the velocity profile at section 1 from a pure plug flow. Note that in die casting, the flow is pushed by the plunger and can be considered as an inlet flow into a duct. The typical Re number is 10^5 , and for this value the entry length is greater than $50m$, which is larger than any shot sleeve by at least two orders of magnitude.

The pressure in the gas phase can be assumed to be constant. The hydrostatic pressure in the liquid can be represent by $R\bar{y}_c g \rho$ (Rajaratnam1965), where $R\bar{y}_c$ is the center of the cross section area. For a constant liquid density equation (8.6) can be rewritten as:

$$\left[R\bar{y}_{c1} g + \gamma_{1\epsilon} \frac{(V_w - V_p)^2}{2} \right] (V_w - V_p) A(h_1) = \left[R\bar{y}_{c2} g + \frac{V_w^2}{2} \right] V_w A(h_2) \quad (8.8)$$

Garber (and later Brevick) put this equation plus several geometrical relationships as the solution. Here we continue to obtain an analytical solution. Defining a dimensionless parameter Fr as

$$Fr = \frac{Rg}{V_p^2}, \quad (8.9)$$

Utilizing definition (8.9) and rearranging equation (8.8) yields

$$2Fr_\epsilon \times \bar{y}_{c1} + \gamma_{1\epsilon} (\tilde{v} - 1)^2 = 2Fr_\epsilon \times \bar{y}_{c2} + \tilde{v}^2 \quad (8.10)$$

Solving equation (8.10) for Fr_ϵ the latter can be further rearranged to yield:

$$Fr_\epsilon = \sqrt{\frac{2(\bar{y}_{c1} - \bar{y}_{c2})}{\frac{(1+\gamma_{1\epsilon})f(h_1, h_2)}{f(h_1, h_2)-1} - \gamma_{1\epsilon}}} \quad (8.11)$$

Given the substrate height, equation (8.11) can be evaluated for the Fr_ϵ , and the corresponding plunger velocity, V_p , which is defined by equation (8.9). This solution will be referred herein as the “energy solution”.

8.2.2 Brevick’s Model

The square shot sleeve

Since Garber’s model never work Brevick and co-workers go on a “fishing expedition” in the fluid mechanics literature to find equations to describe the wave. They found in Lamb’s book several equations relating the wave velocity to the wave height for a deep liquid (water)⁸. Since these equations are for a two dimensional case, Brevick and co-workers built it for a squared

⁸I have checked the reference and I still puzzled by the equations they found?

shot sleeve. Here are the equations that they used. The “instantaneous” height difference ($\Delta h = h_1 - h_2$) is given as

$$\Delta h = h_2 \left[\frac{V_p}{2\sqrt{gh_2}} + 1 \right]^2 - h_2 \quad (8.12)$$

This equation (8.12), with little rearranging, obtained a new form

$$V_p = 2\sqrt{gh_2} \left[\sqrt{\frac{h_1}{h_2}} - 1 \right] \quad (8.13)$$

The wave velocity is given by

$$V_w = \sqrt{gh_2} \left[3\sqrt{1 + \frac{\Delta h}{h_2}} - 2 \right] \quad (8.14)$$

Brevick introduces the optimal plunger acceleration concept. “By plotting the height and position of each incremental wave with time, their model is able to predict the ‘stability’ of the resulting wave front when the top of the front has traveled the length of the shot sleeve.”⁹. They then performed experiments on this “miracle acceleration”¹⁰.

8.2.3 Brevick’s circular model

Probably, because it was clear to the authors that the previous model was only good for a square shot sleeve¹¹. They say let reuse Garber’s model for every short time steps and with different velocity (acceleration).

8.2.4 Miller’s square model

Miller and his student borrowed a two dimensional model under assumption of turbulent flow. They assumed that the flow is “infinite” turbulence and therefore it is a plug flow¹². Since the solution was for 2D they naturally build model for a square shot sleeve¹³. The mass balance for square shot sleeve

$$V_w h_2 = (V_w - V_p) h_1 \quad (8.15)$$

Momentum balance on the same control volume yield

$$\left[\frac{P_B}{\rho} + \frac{(V_w - V_p)^2}{2} \right] (V_w - V_p) h_1 = \left[\frac{P_2}{\rho} + \frac{V_w^2}{2} \right] V_w h_2 \quad (8.16)$$

⁹What an interesting idea?? Any physics?

¹⁰As to say this is not good enough a fun idea, they also “invented” a new acceleration units “cm/sec-cm”.

¹¹It is not clear whether they know that this equations are not applicable even for a square shot sleeve.

¹²How they come-out with this conclusion?

¹³Why are these two groups from the same university and the same department not familiar with each others work.

and the solution of these two equations is

$$Fr_{miller} = \frac{1}{2} \frac{h_1}{h_2} \left(\frac{h_1}{h_2} + 1 \right) \quad (8.17)$$

8.3 The validity of the “common” models

8.3.1 Garber’s model

Energy is known to dissipate in a hydraulic jump in which case the equal sign in equation (8.11) does not apply and the criterion for a nonsplashing operation would read

$$Fr_{\epsilon} < Fr_{optimal} \quad (8.18)$$

A considerable amount of research work has been carried out on this wave, which is known in the scientific literature as the hydraulic jump. The hydraulic jump phenomenon has been studied for the past 200 years. Unfortunately, Garber, (and later other researchers in die casting – such as Brevick and his students from Ohio State University (Brevick, Armentrout and Chu1994), (Thome and Brevick1995))¹⁴, ignored the previous research. This is the real reason that their model never works.

8.3.2 Brevick’s models

square model

There are two basic mistakes in this model, first) the basic equations are not applicable to the shot sleeve situation, second) the square geometry is not found in the industry. To illustrate why the equations Brevick chose are not valid, take the case where $1 > h_1/h_2 > 4/9$. For that case V_w is positive and yet the hydraulic jump opposite to reality ($h_1 < h_2$).

Improved Garber’s model

Since Garber’s model is scientific erroneous any derivative that is based on it no better than its foundation¹⁵.

8.3.3 Miller’s model

The flow in the shot sleeve is not turbulent¹⁶. The flow is a plug flow because entry length problem¹⁷.

Besides all this, the geometry of the shot sleeve is circular. This mistake is discussed in the comparison in the discussion section of this chapter.

¹⁴Even with these major mistakes NADCA under the leadership of Gary Pribyl and Steve Udvardy continues to award Mr. Brevick with additional grants to continue this research until now, Why?

¹⁵I wonder how much NADCA paid Brevick for this research?

¹⁶Unless someone can explain and/or prove otherwise.

¹⁷see Chapter 3.

8.3.4 EKK's model (numerical model)

This model based on numerical simulations based on the following assumptions: 1) the flow is turbulent, 2) turbulence was assume to be isentropic homogeneous every where (k-ε model), 3) un-specified boundary conditions at the free interface (how they solve it with this kind of condition?), and 4) unclear how they dealt with the "corner point" in which plunger premiter in which smart way is required to deal with zero velocity of the sleeve and known velocity of plunger.

Several other assumptions implicitly are in that work¹⁸ such as no heat transfer, a constant pressure in the sleeve etc.

According to their calculation a jet exist somewhere in the flow field. They use the k-ε model for a field with zero velocity! They claim that they found that the critical velocity to be the same as in Garber's model. The researchers have found same results regadless the model used, turbulent and laminar flow!! One can only wonder if the usage of k-ε model (even for zero velocity field) was enough to produce these erroneous results or perhaps the problem lays within the code itself¹⁹.

8.4 The Reformed Model

The hydraulic jump appears in steady-state and unsteady-state situations. The hydraulic jump also appears when using different cross-sections, such as square, circular, and trapezoidal shapes. The hydraulic jump can be moving or stationary. The "wave" in the shot sleeve is a moving hydraulic jump in a circular cross-section. For this analysis, it does not matter if the jump is moving or not. The most important thing to understand is that a large portion of the energy is lost and that this cannot be neglected. All the fluid mechanics books²⁰ show that Garber's formulation is not acceptable and a different approach has to be employed. Today, the solution is available to die casters in a form of a computer program – DiePerfect™.

8.4.1 The reformed model

In this section the momentum conservation principle is applied on the control volume in Figure 8.3. For large Re ($\sim 10^5$) the wall shear stress can be neglected compared to the inertial terms (the wave is assumed to have a negligible length). The momentum balance reads:

$$\int_{A_1} [P_B + \rho\gamma_{1M}(V_w - V_p)^2] dA = \int_{A_2} [P_2 + \rho V_w^2] dA \quad (8.19)$$

where

$$\gamma_{1M} = \frac{1}{A_1(V_w - V_p)^2} \int_{A_1} (V_w - v_1)^2 dA = \frac{1}{A_1(\tilde{v} - 1)^2} \int_{A_1} \left(\tilde{v} - \frac{v_1}{V_p} \right)^2 dA \quad (8.20)$$

¹⁸This paper is a good example of poor research related to a poor presentation and text processing.

¹⁹see remark on page 30

²⁰in the last 100 years

Section 8.4. The Reformed Model

Given the velocity profile v_1 , the shape factor γ_{1M} can be obtained in terms of \tilde{v} . The expressions for γ_{1M} for laminar and turbulent velocity profiles at section 1 easily can be calculated. Based on the assumptions used in the previous section, equation (8.19) reads:

$$\left[R\overline{y_{c1}g} + \gamma_{1M}(V_w - V_p)^2 \right] A(h_1) = \left[R\overline{y_{c2}g} + V_w^2 \right] A(h_2) \quad (8.21)$$

Rearranging equation (8.21) into a dimensionless form yields:

$$f(h_1, h_2) \left[\overline{y_{c1}Fr} + \gamma_{1M}(\tilde{v} - 1)^2 \right] = \overline{y_{c2}Fr} + \tilde{v}^2 \quad (8.22)$$

Combining equations (8.5) and (8.22) yields

$$Fr_M = \frac{\left[\frac{f(h_1, h_2)}{f(h_1, h_2) - 1} \right]^2 - \gamma_{1M} f(h_1, h_2) \left[\left(\frac{f(h_1, h_2)}{f(h_1, h_2) - 1} \right) - 1 \right]^2}{[f(h_1, h_2)\overline{y_{c1}} - \overline{y_{c2}}]} \quad (8.23)$$

where Fr_M is the Fr number which evolves from the momentum conservation equation. Equation (8.23) is the analogue of equation (8.11) and will be referred herein as the “Bar–Meir’s solution”.

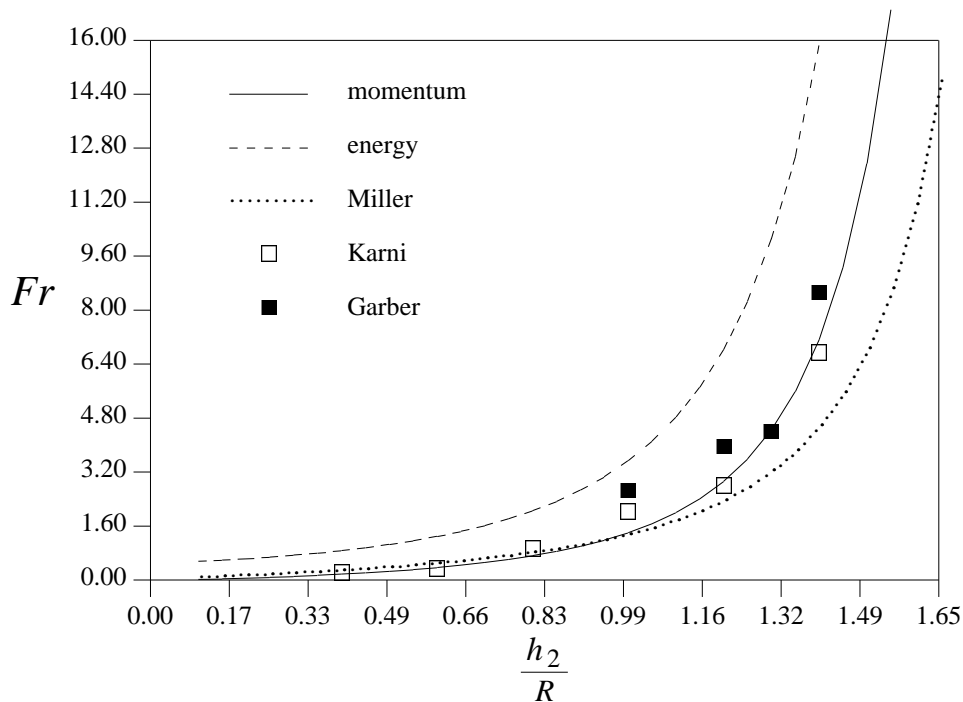

Figure 8.4: The Froude number as a function of the relative height

It has been found that the solutions of the “Bar–Meir’s solution”²¹ and the “energy solution” can be presented in a simple form. Moreover, these solutions can be applied to

²¹This model was constructed with a cooperation of another researcher.

any cross section for the transition of the free surface flow to pressurized flow. The discussion here focuses on the circular cross section, since it is the only one used by diecasters. Solutions for other velocity profiles, such as laminar flow (Poiseuille paraboloid), are discussed in the Appendix ²². Note that the Froude number is based on the plunger velocity and not on the upstream velocity commonly used in the two-dimensional hydraulic jump.

The experimental data obtained by Garber (Garber1982), and Karni (Karni1991) and the transition from the free surface flow to pressurized flow represented by equations (8.11) and (8.23) for a circular cross section are presented in Figure 8.4 for a plug flow. The Miller's model (two dimensional) of the hydraulic jump is also presented in Figure 8.4. This Figure shows clearly that the "Bar-Meir's solution" is in agreement with Karni's experimental results. The agreement between Garber's experimental results and the "Bar-Meir's solution," with the exception of one point (at $h_2 = R$), is good.

The experimental results obtained by Karni were taken when the critical velocity was obtained (liquid reached the pipe crown) while the experimental results from Garber are interpretation (kind of average) of subcritical velocities and supercritical velocities with the exception of the one point at $h_2/R = 1.3$ (which is very closed to the "Bar-Meir's solution"). Hence, it is reasonable to assume that the accuracy of Karni's results is better than Garber's results. However, these data points have to be taken with some caution²³. Non of the experimental data sets were checked if a steady state was achieved and it is not clear how the measurements carried out.

It is widely accepted that in the two dimensional hydraulic jump small and large eddies are created which are responsible for the large energy dissipation (Henderson1966). Therefore, energy conservation cannot be used to describe the hydraulic jump heights. The same can be said for the hydraulic jump in different geometries. Of course, the same has to be said for the circular cross section. Thus, the plunger velocity has to be greater than the one obtained by Garber's model, which can be observed in Figure 8.4. The Froude number for the Garber's model is larger than the Froude number obtained in the experimental results. Froude number inversely proportional to square of the plunger velocity, $Fr \propto 1/V_p^2$ and hence the velocity is smaller. The Garber's model therefore underestimates the plunger velocity.

8.4.2 Design process

To obtain the critical slow plunger velocity, one has to follow this procedure:

1. Calculate/estimate the weight of the liquid metal.
2. Calculate the volume of the liquid metal (make sure that you use the liquid phase property and not the solid phase).
3. Calculate the percentage of filling in the shot sleeve, $\frac{height}{r}$.
4. Find the Fr number from Figure 8.4.
5. Use the Fr number found to calculate the plunger velocity by using equation (8.9).

²²To appear in the next addition.

²³Results of good experiments performed by serious researchers are welcome.

8.5 Summary

In this Chapter we analyzed the flow in the shot sleeve and developed an explicit expression to calculate the required plunger velocity. It has been shown that Garber's model is totally wrong and therefore Brevick's model is necessarily erroneous as well. The same can be said to all the other models discussed in this Chapter. The connection between the "wave" and the hydraulic jump has been explained. The method for calculating the critical slow plunger velocity has been provided.

8.6 Questions

8.2.1 What is justification for equation 8.2?

8.2.1 Show that $A(h_1) = 2\pi R^2$ for $h_1 = 2R$

8.2.1 under-construction

8.3.1 Show the relative error created by Garber's model when the substrate height h_2 is the varying parameter.

CHAPTER 9

Venting System Design

The difference between the two is expressed by changing standard atmospheric ambient conditions to those existing in the vacuum tank.

Miller's student, p. 102

9.1 Introduction

Proper design of the venting system is one of the requirements for reducing air/gas porosity. Porosity due to entrainment of gases constitutes a large portion of the total porosity, especially when the cast walls are very thin (see Figure 9.1). The main causes of air/gas porosity are insufficient vent area, lubricant evaporation (reaction processes), incorrect placement of the vents, and the mixing processes. The present chapter considers the influence of the vent area (in atmospheric and vacuum venting) on the residual gas (in the die) at the end of the filling process.

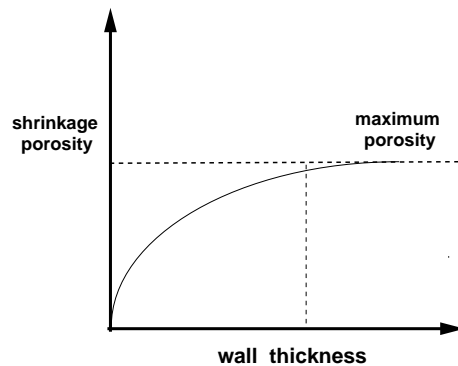

Figure 9.1: The relative shrinkage porosity as a function of the casting thickness

Atmospheric venting, the most widely used casting method, is one in which the vent is opened to the atmosphere and is referred herein as air venting. Only in extreme cases are other solutions required, such as vacuum venting, Pore Free Technique (in zinc and aluminum casting) and squeeze casting. Vacuum is applied to extract air/gas from the mold before it has the opportunity to mix with the liquid metal and it is called vacuum venting. The Pore Free technique is a variation of the vacuum venting in which the oxygen is introduced into the cavity to replace the air and to react with the liquid metal, and therefore creates a vacuum (Bar-Meir1995b). Squeeze casting is a different approach in which the surface tension is increased to reduce the possible mixing processes (smaller Re number as well). The gases in the shot sleeve and cavity are made mostly of air and therefore the term "air" is used hereafter. These three "solutions" are cumbersome and create a far more expensive process. In this chapter, a qualitative discussion on when these solutions should be used and when they are not needed is presented.

Obviously, the best ventilation is achieved when a relatively large vent area is designed. However, to minimize the secondary machining (such as trimming), to ensure freezing within the venting system, and to ensure breakage outside the cast mold, vents have to be very narrow. A typical size of vent thicknesses range from 1–2[mm]. These conflicting requirements on the vent area suggest an optimum area. As usual the "common" approach is described the errors are presented and the reformed model is described.

9.2 The "common" models

9.2.1 Early (etc.) model

The first model dealing with the extraction of air from the cavity was done by Sachs. In this model, Sachs (Sachs1952) developed a model for the gas flow from a die cavity based on the following assumptions: 1) the gas undergoes an isentropic process in the die cavity, 2) a quasi steady state exists, 3) the only resistance to the gas flow is at the entrance of the vent, 4) a "maximum mass flow rate is present", and 5) the liquid metal has no surface tension, thus the metal pressure is equal to the gas pressure. Sachs also differentiated between two cases: choked flow and un-choked flow (but this differentiation did not come into play in his model). Assumption 3 requires that for choked flow the pressure ratio be about two between the cavity and vent exit.

Almost the same model was repeated by several researchers¹. All these models, with the exception of Veinik (Veinik1966), neglect the friction in the venting system. The vent design in a commercial system includes at least an exit, several ducts, and several abrupt expansions/contractions in which the resistance coefficient ($\frac{4fL}{D}$ see (Shapiro1953, page 163)) can be evaluated to be larger than 3 and a typical value of $\frac{4fL}{D}$ is about 7 or more. In this case, the pressure ratio for the choking condition is at least 3 and the pressure ratio reaches this value only after about 2/3 of the piston stroke is elapsed. It can be shown that when the flow is choked the pressure in the cavity does not remain constant as assumed in the models but increases exponentially.

¹Apparently, no literature survey was required/available/needed at that time.

9.2.2 Miller's model

Miller and his student, in the early 90's, constructed a model to account for the friction in the venting system. They based their model on the following assumptions:

1. No heat transfer
2. Isothermal flow (constant temperature) in the entrance to vent (according to the authors in the presentation)
3. Fanno flow in the rest vent
4. Air/gas obeys the ideal gas model

Miller and his student described the calculation procedures for the two cases as choked and unchoked conditions. The calculations for the choked case are standard and can be found in any book about Fanno flow but with an interesting twist. The conditions in the mold and the sleeve are calculated according to the ambient condition (see the smart quote of this Chapter)². The calculations about the unchoked case are very interesting and will be discussed here in a little more detail. The calculation procedure for the unchoked case is as follows:

- Assume M_{in} number (entrance Mach number to the vent) lower than M_{in} for choked condition
- Calculate the corresponding star (choked conditions) $\frac{4fL}{D}$, the pressure ratio, and the temperature ratio for the assumed M_{in} number
- Calculate the difference between the calculated $\frac{4fL}{D}$ and the actual $\frac{4fL}{D}$.
- Use the difference $\frac{4fL}{D}$ to calculate the double star (theoretical exit) conditions based on the ambient conditions.
- Calculate the conditions in the die based on the double star conditions.

Now the mass flow out is determined by mass conservation.

Of course, these calculations are erroneous. In choked flow, the conditions are determined **only and only** by up-stream and never by the downstream³. The calculations for unchoked flow are mathematically wrong. The assumption made in the first step never was checked. And mathematically speaking, it is equivalent to just guessing a solution. These errors are only a fraction of the other errors in that model which include among others the following: one) assumption of constant temperature in the die is wrong, two) poor assumption of isothermal flow, three) poor measurements etc. On top of that was the criterion for required vent area.

²This model results in negative temperature in the shot sleeve in typical range.

³How otherwise, can it be? It is like assuming negative temperature in the die cavity during the injection. Is it realistic?

9.3 General Discussion

When a noncompressible liquid such as water is pushed, the same amount propelled by the plunger will flow out of the system. However, air is a compressible substance and thus the above statement cannot be applied. The flow rate out depends on the resistance to the flow plus the piston velocity (piston area as well). There could be three situations 1) the flow rate out is **less** than the volume pushed by the piston, 2) the flow rate out is **more** than the volume pushed by the piston, or 3) the flow rate out is **equal** to the volume pushed by the piston. The last case is called the critical design, and it is associated with the critical area.

Air flows in the venting system can reach very large velocities up to about 350 [m/sec]. The air cannot exceed this velocity without going through a specially configured conduit (converging diverging conduit). This phenomena is known by the name of "choked flow". This physical phenomenon is the key to understanding the venting design process. In air venting, the venting system has to be designed so that air velocity does not reach the speed of sound: in other words, **the flow is not choked**. In vacuum venting, the air velocity reaches the speed of sound almost instantaneously, and the design should be such that it ensures that the air pressure does not exceed the atmospheric pressure.

Prior models for predicting the optimum vent area did not consider the resistance in the venting system (pressure ratio of less than 2). The vent design in a commercial system includes at least an exit, several ducts, and several abrupt expansions/contractions in which the resistance coefficient, $\frac{4fL}{D}$, is of the order of 3–7 or more. Thus, the pressure ratio creating choked flow is at least 3. One of the differences between vacuum venting and atmospheric venting occurs during the start-up time. For vacuum venting, a choking condition is established almost instantaneously (it depends on the air volume in the venting duct), while in the atmospheric case the volume of the air has to be reduced to more than half (depending on the pressure ratio) before the choking condition develops - - and this can happen only when more than 2/3 or more of the piston stroke is elapsed. Moreover, the flow is not necessarily choked in atmospheric venting. Once the flow is choked, there is no difference in calculating the flow between these two cases. It turns out that the mathematics in both cases are similar, and therefore both cases are presented in the present chapter.

The role of the chemical reactions was shown to be insignificant. The difference in the gas solubility (mostly hydrogen) in liquid and solid can be shown to be insignificant (ASM1987). For example, the maximum hydrogen release during solidification of a kilogram of aluminum is about 7cm^3 at atmospheric temperature and pressure. This is less than 3% of the volume needed to be displaced, and can be neglected. Some of the oxygen is depleted during the filling time (Bar-Meir1995b). The last two effects tend to cancel each other out, and the net effect is minimal.

The numerical simulations produce unrealistic results and there is no other quantitative tools for finding the vent locations (the last place(s) to be filled) and this issue is still an open question today. There are, however, qualitative explanations and reasonable guesses that can push the accuracy of the last place (the liquid metal reaches) estimate to be within the last 10%–30% of the filling process. This information increases the significance of the understanding of what is the required vent area. Since most of the air has to be vented during the initial stages of the filling process, in which the vent locations do not play a role.

Air venting is the cheapest method of operation, and it should be used unless acceptable

results cannot be obtained using it. Acceptable results are difficult to obtain 1) when the resistance to the air flow in the mold is more significant than the resistance in the venting system, and 2) when the mixing processes are augmented by the specific mold geometry. In these cases, the extraction of the air prior to the filling can reduce the air porosity which require the use of other techniques.

An additional objective is to provide a tool to “combine” the actual vent area with the resistance (in the venting system) to the air flow; thus, eliminating the need for calculations of the gas flow in the vent in order to minimize the numerical calculations. Hu et al. (Hu et al.1992) and others have shown that the air pressure is practically uniform in the system. Hence, this analysis can also provide the average air pressure that should be used in numerical simulations.

9.4 The Analysis

The model is presented here with a minimal of mathematical details. However, emphasis is given to all the physical understanding of the phenomena. The interested reader can find more detailed discussions in several other sources (Bar-Meir1995a). As before, the integral approach is employed. All the assumptions which are used in this model are stated so that they can be examined and discussed at the conclusion of the present chapter. Here is a list of the assumptions which are used in developing this model:

1. The main resistance to the air flow is assumed to be in the venting system.
2. The air flow in the cylinder is assumed one-dimensional.
3. The air in the cylinder undergoes an isentropic process.
4. The air obeys the ideal gas model, $P = \rho RT$.
5. The geometry of the venting system does not change during the filling process (i.e., the gap between the plates does not increase during the filling process).
6. The plunger moves at a constant velocity during the filling process, and it is determined by the pQ^2 diagram calculations.
7. The volume of the venting system is negligible compared to the cylinder volume.
8. The venting system can be represented by one long, straight conduit.
9. The resistance to the liquid metal flow, $\frac{4fL}{D}$, does not change during the filling process (due to the change in the Re , or Mach numbers).
10. The flow in the venting system is an adiabatic flow (Fanno flow).
11. The resistance to the flow, $\frac{4fL}{D}$, is not affected by the change in the vent area.

With the above assumptions, the following model as shown in Figure 9.2 is proposed. A plunger pushes the liquid metal, and both of them (now called as the piston) propel the air through a long, straight conduit.

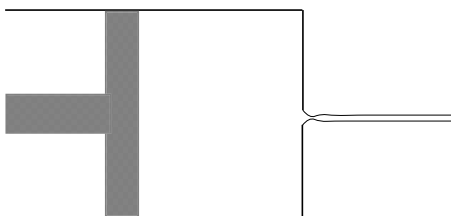

Figure 9.2: A simplified model for the venting system

The mass balance of the air in the cylinder yields

$$\frac{dm}{dt} + \dot{m}_{out} = 0. \quad (9.1)$$

This equation (9.1) is the only equation that needed to be solved. To solve it, the physical properties of the air need to be related to the geometry and the process. According to assumption 4, the air mass can be expressed as

$$m = \frac{PV}{RT} \quad (9.2)$$

The volume of the cylinder under assumption 6 can be written as

$$\frac{V(t)}{V(0)} = \left(1 - \frac{t}{t_{max}}\right) \quad (9.3)$$

Thus, the first term in equation (9.1) is represented by

$$\frac{dm}{dt} = \frac{d}{dt} \left(\frac{PV(0) \left(1 - \frac{t}{t_{max}}\right)}{RT} \right) \quad (9.4)$$

The filling process occurs within a very short period time [*milliseconds*], and therefore the heat transfer is insignificant 3. This kind of flow is referred to as Fanno flow⁴. The instantaneous flow rate has to be expressed in terms of the resistance to the flow, $\frac{4fL}{D}$, the pressure ratio, and the characteristics of Fanno flow (Shapiro1953). Knowledge of Fanno flow is required for expressing the second term in equation (9.1).

The mass flow rate can be written as

$$\dot{m}_{out} = P_0(0)AM_{max} \frac{M_{in}(t)}{M_{max}} \left(\frac{P_0(0)}{P_0(t)} \right)^{\frac{k+1}{2k}} \sqrt{\frac{k}{RT_0(0)}} f[M_{in}(t)] \quad (9.5)$$

where

$$f[M_{in}(t)] = \left[1 + \frac{k-1}{2} (M_{in}(t))^2 \right]^{\frac{-(k+1)}{2(k-1)}} \quad (9.6)$$

⁴Fanno flow has been studied extensively, and numerous books describing this flow can be found. Nevertheless, a brief summary on Fanno flow is provided in Appendix D.

Section 9.5. Results and Discussion

The Mach number at the entrance to the conduit, $M_{in}(t)$, is calculated by Fanno flow characteristics for the venting system resistance, $\frac{4fL}{D}$, and the pressure ratio. M_{max} is the maximum value of $M_{in}(t)$. In vacuum venting, the entrance Mach number, $M_{in}(t)$, is constant and equal to M_{max} .

Substituting equations (9.4) and (9.5) into equation (9.1), and rearranging, yields:

$$\frac{d\bar{P}}{d\bar{t}} = \frac{k \left(1 - \frac{t_{max}}{t_c} \bar{M} f(M_{in}) \bar{P}^{\frac{k-1}{2k}} \right)}{1 - \bar{t}} \bar{P}; \quad \bar{P}(0) = 1. \quad (9.7)$$

The solution to equation (9.7) can be obtained by numerical integration for \bar{P} . The residual mass fraction in the cavity as a function of time is then determined using the "ideal gas" assumption. It is important to point out the significance of the $\frac{t_{max}}{t_c}$. This parameter represents the ratio between the filling time and the evacuation time. t_c is the time which would be required to evacuate the cylinder for a constant mass flow rate at the maximum Mach number when the gas temperature and pressure remain at their initial values, under the condition that the flow is choked, (The pressure difference between the mold cavity and the outside end of the conduit is large enough to create a choked flow.) and expressed by

$$t_c = \frac{m(0)}{AM_{max}P_0(0)\sqrt{\frac{k}{RT_0(0)}}} \quad (9.8)$$

Critical condition occurs when $t_c = t_{max}$. In vacuum venting, the volume pushed by the piston is equal to the flow rate, and ensures that the pressure in the cavity does not increase (above the atmospheric pressure). In air venting, the critical condition ensures that the flow is not choked. For this reason, the critical area A_c is defined as the area that makes the time ratio t_{max}/t_c equal to one. This can be done by looking at equation (9.8), in which the value of t_c can be varied until it is equal to t_{max} and so the critical area is

$$A_c = \frac{m(0)}{t_{max}M_{max}P_0(0)\sqrt{\frac{k}{RT_0(0)}}} \quad (9.9)$$

Substituting equation (9.2) into equation (9.9), and using the fact that the sound velocity can be expressed as $c = \sqrt{kRT}$, yields:

$$A_c = \frac{V(0)}{ct_{max}M_{max}} \quad (9.10)$$

where c is the speed of sound at the initial conditions inside the cylinder (ambient conditions). The t_{max} should be expressed by Eckert/Bar–Meir equation.

9.5 Results and Discussion

The results of a numerical evaluation of the equations in the proceeding section are presented in Figure 9.3, which exhibits the final pressure when 90% of the stroke has elapsed as a function of $\frac{A}{A_c}$.

Parameters influencing the process are the area ratio, $\frac{A}{A_c}$, and the friction parameter, $\frac{4fL}{D}$. From other detailed calculations (Bar-Meir1995a) it was found that the influence of the parameter $\frac{4fL}{D}$ on the pressure development in the cylinder is quite small. The influence is small on the residual air mass in the cylinder, but larger on the Mach number, M_{exit} . The effects of the area ratio, $\frac{A}{A_c}$, are studied here since it is the dominant parameter.

Note that t_c in air venting is slightly different from that in vacuum venting (Bar-Meir, Eckert and Goldstein1996) by a factor of $f(M_{max})$. This factor has significance for small $\frac{4fL}{D}$ and small $\frac{A}{A_c}$ when the Mach number is large, as was shown in other detailed calculations (Bar-Meir1995a). The definition chosen here is based on the fact that for a small Mach number the factor $f(M_{max})$ can be ignored. In the majority of the cases M_{max} is small.

For values of the area ratio greater than 1.2, $\frac{A}{A_c} > 1.2$, the pressure increases the volume flow rate of the air until a quasi steady-state is reached. In air venting, this quasi steady-state is achieved when the volumetric air flow rate out is equal to the volume pushed by the piston. The pressure and the mass flow rate are maintained constant after this state is reached. The pressure in this quasi steady-state is a function of $\frac{A}{A_c}$. For small values of $\frac{A}{A_c}$ there is no steady-state stage. When $\frac{A}{A_c}$ is greater than one the pressure is concave upwards, and when $\frac{A}{A_c}$ is less than one the pressure is concave downwards. These results are in direct contrast to previous molds by Sachs (Sachs1952), Draper (Draper1967), Veinik (Veinik1962) and Lindsey and Wallace (Lindsey and Wallace1972), where models assumed that the pressure and mass flow rate remain constant and are attained instantaneously for air venting.

Figure 9.3: The pressure ratios for air and vacuum venting at 90% of the piston stroke

To refer to the stroke completion (100% of the stroke) is meaningless since 1) no gas mass is left in the cylinder, thus no pressure can be measured, and 2) the vent can be blocked partially or totally at the end of the stroke. Thus, the "completion" (end of the process) of the filling process is described when 90% of the stroke is elapsed. Figure 9.3 presents the final pressure ratio as a function $\frac{A}{A_c}$ for $\frac{4fL}{D} = 5$. The final pressure (really the pressure ratio) depends strongly on $\frac{A}{A_c}$ as described in Figure 9.3. The pressure in the die cavity increases by about 85% of its initial value when $\frac{A}{A_c} = 1$ for air venting. The pressure remains almost constant after $\frac{A}{A_c}$ reaches the value of 1.2. This implies that the vent area is sufficiently large when $\frac{A}{A_c} = 1.2$ for air venting and when $\frac{A}{A_c} = 1$ for vacuum venting. Similar results can be observed when the residual mass fraction is plotted.

This discussion and these results are perfectly correct in a case where all the assumptions are satisfied. However, the real world is different and the assumptions have to be examined and some of them are:

1. Assumption 1 is not a restriction to the model, but rather guide in the design. The engineer has to ensure that the resistance in the mold to air flow (and metal flow) has to be as small as possible. This guide dictates that engineer designs the path for air (and the liquid metal) as as short as possible.
2. Assumptions 3, 4, and 10 are very realistic assumptions. For example, the error in using assumption 4 is less than 0.5%.

Section 9.5. Results and Discussion

3. This model is an indication when assumption 5 is good. In the initial stages (of the filling process) the pressure is very small and in this case the pressure (force) to open the plates is small, and therefore the gap is almost zero. As the filling process progresses, the pressure increases, and therefore the gap is increased. A significant gap requires very significant pressure which occurs only at the final stages of the filling process and only when the area ratio is small, $\frac{A}{A_C} < 1$. Thus, this assumption is very reasonable.
4. Assumption 6 is associated with assumption 9, but is more sensitive. The change in the resistance (a change in assumption in 9 creates consequently a change in the plunger velocity. The plunger reaches the constant velocity very fast, however, this velocity decrease during the duration of the filling process. The change again depends on the resistance in the mold. This can be used as a guide by the engineer and enhances the importance of creating a path with a minimum resistance to the flow.
5. Another guide for the venting system design (in vacuum venting) is assumption 7. The engineer has to reduce the vent volume so that less gas has to be evacuated. This restriction has to be design carefully keeping in mind that the resistance also has to be minimized (some what opposite restriction). In air venting, when this assumption is not valid, a different model describes the situation. However, not fulfilling the assumption can improve the casting because larger portion of the liquid metal which undergoes mixing with the air is exhausted to outside the mold.
6. Assumption 8 is one of the bad assumptions in this model. In many cases there is more than one vent, and the entrance Mach number for different vents could be a different value. Thus, the suggested method of conversion is not valid, and therefore the value of the critical area is not exact. A better, more complicated model is required. This assumption cannot be used as a guide for the design since as better venting can be achieved (and thus enhancing the quality) without ensuring the same Mach number.
7. Assumption 9 is a partially appropriate assumption. The resistance in venting system is a function of Re and Mach numbers. Yet, here the resistance, $\frac{4fL}{D}$, is calculated based on the assumption that the Mach number is a constant and equal to M_{max} . The error due to this assumption is large in the initial stages where Re and Mach numbers are small. As the filling progress progresses, this error is reduced. In vacuum venting the Mach number reaches the maximum instantly and therefore this assumption is exact. The entrance Mach number is very small (the flow is even not choke flow) in air venting when the area ratio, $\frac{A}{A_C} \gg 1$ is very large and therefore the assumption is poor. However, regardless the accuracy of the model, the design achieves its aim and the trends of this model are not affected by this error. Moreover, this model can be improved by taking into consideration the change of the resistance.
8. The change of the vent area does affect the resistance. However, a detailed calculation can show that as long as the vent area is above half of the typical cross section, the error is minimal. If the vent area turns out to be below half of the typical vent cross section a improvement is needed.

9.6 Summary

This analysis (even with the errors) indicates there is a critical vent area below which the ventilation is poor and above which the resistance to air flow is minimal. This critical area depends on the geometry and the filling time. The critical area also provides a mean to “combine” the actual vent area with the vent resistance for numerical simulations of the cavity filling, taking into account the compressibility of the gas flow. Importance of the design also was shown.

9.7 Questions

Under construction

CHAPTER 10

Clamping Force Calculations

Under construction

Part III

MORE INFO: Appendixes

APPENDIX A

What The Establishment's Scientists Say

What a Chutzpah? to say something like that!

anonymous

In this section exhibits the establishment "experts" reaction the position that the "common" pQ^2 diagram is improper. Their comments are responses to the author's paper: "The mathematical theory of the pQ^2 diagram" (similar to Chapter 7)¹. The paper was submitted to Journal of Manufacturing Science and Engineering.

This part is for the Associate Technical Editor Dr. R. E. Smelser.

I am sure that you are proud of the referees that you have chosen and that you do not have any objection whatsoever with publishing this information. Please send a copy of this appendix to the referees. I will be glad to hear from them.

This concludes comments to the Editor.

I believe that you, the reader should judge if the mathematical theory of the pQ^2 diagram is correct or whether the "experts" position is reasonable. For the reader unfamiliar with the journal review process, the associate editor sent the paper to "readers" (referees) which are anonymous to the authors. They comment on the paper and according to these experts the paper acceptance is determined. I have chosen the unusual step to publish their comments because I believe that other motivations are involved in their responses. Coupled with the response to the publication of a summary of this paper in the Die Casting Engineer, bring me to think that the best way to remove the information blockage is to open it to the public.

¹The exact paper can be obtain free of charge from Minnesota Suppercomputing Institute, <http://www2.msi.umn.edu/publications.html> report number 99/40 "The mathematical theory of the pQ^2 diagram" or by writing to the Supercomputing Institute, University of Minnesota, 1200 Washington Avenue South, Minneapolis, MN 55415-1227

Here, the referees can react to this rebuttal and stay anonymous via correspondence with the associated editor. If the referee/s choose to respond to the rebuttal, their comments will appear in the future additions. I will help them as much as I can to show their opinions. I am sure that they are proud of their criticism and are standing behind it 100%. Furthermore, I am absolutely, positively sure that they are so proud of their criticism they glad that it appears in publication such as this book.

A.1 Summary of Referee positions

The critics attack the article in three different ways. All the referees try to deny publication based on grammar!! The first referee didn't show any English mistakes (though he alleged that he did). The second referee had some hand written notes on the preprint (two different hand writing?) but it is not the grammar but the content of the article (the fact that the "common" pQ^2 diagram is wrong) is the problem.

Here is an original segment from the submitted paper:

The design process is considered an art for the 8-billion-dollar die casting industry. The pQ^2 diagram is the most common calculation, if any that all, are used by most die casting engineers. The importance of this diagram can be demonstrated by the fact that tens of millions of dollars have been invested by NADCA, NSF, and other major institutes here and abroad in pQ^2 diagram research.

In order to correct "grammar", the referee change to:

The pQ^2 diagram is the most common calculation used by die casting engineers to determine the relationship between the die casting machine and gating design parameters, and the resulting metal flow rate.

It seems, the referee would not like some facts to be written/known.

Summary of the referees positions:

Referee 1 Well, the paper was published before (NADCA die casting engineer) and the errors in the "common" pQ^2 are only in extreme cases. Furthermore, it actually supports the "common" model.

Referee 2 Very angrily!! How dare the authors say that the "common" model is wrong. When in fact, according to him, it is very useful.

Referee 3 The bizzarro approach! Changed the meaning of what the authors wrote (see the "oveled boxed" comment for example). This produced a new type logic which is almost absurd. Namely, the discharge coefficient, C_D , is constant for a runner or can only vary with time. The third possibility, which is the topic of the paper, the fact that C_D cannot be assigned a runner system but have to calculated for every set of runner and die casting machine can not exist possibility, and therefore the whole paper is irrelevant.

Genick Bar-Meir's answer:

Let me say what a smart man once said before:
I don't need 2000 scientists to tell me that I am
wrong. What I need is one scientist to show what
is wrong in my theory.

Please read my rebuttal to the points the referees made. The referees version are kept as close as possible to the original. I put some corrections in a square bracket [] to clarify the referees point.

Referee comments appear in roman font like this sentence,
and rebuttals appear in a courier font as this sentence.

A.2 Referee 1 (from hand written notes)

1. Some awkward grammar – See highlighted portions

Where?

2. Similarity of the submitted manuscript to the attached Die Casting Engineer Trade journal article (May/June 1998) is Striking.

The article in Die Casting Engineer is a summary of the present article. It is mentioned there that it is a summary of the present article. There is nothing secret about it. This article points out that the ‘‘common’’ model is totally wrong. This is of central importance to die casting engineers. The publication of this information cannot be delayed until the review process is finished.

3. It is not clear to the reader why the ‘‘constant pressure’’ and ‘‘constant power’’ situations were specifically chosen to demonstrate the author’s point. Which situation is most like that found [likely found] in a die casting machine? Does the ‘‘constant pressure’’ correspond closely to older style machines when intensifier [intensifier] bottle pressure was applied to the injection system unthrottled? Does the ‘‘constant power’’ situations assume a newer machines, such as Buher Sc, that generates the pressure required to achieve a desired gate velocity? Some explanation of the logic of selecting these two situations would be helpful in the manuscript.

As was stated in the article, these situations were chosen because they are building blocks but more importantly to demonstrate that the ‘‘common’’ model is totally wrong! If it is wrong for two basic cases it should be absolutely wrong in any combinations of the two cases. Nevertheless, an additional explanation is given in Chapter 7.

4. The author's approach is useful? Gives perspective to a commonly used process engineering method (pQ^2) in die casting. Some of the runner lengths chosen (1 meter) might be consider exceptional in die casting – yet the author uses this to show how much in error an “average” value for C_D can be. The author might also note that the North American Die Casting Association and many practitioners use a A_3/A_2 ratio of $\approx .65$ as a design target for gating. The author's analysis reinforces this value as a good target, and that straying far from it may results in poor design part filling problems (Fig. 5)

The reviewer refers to several points which are important to address. All the four sizes show large errors (we do not need to take 1[m] to demonstrate that). The one size, the referee referred to as exceptional (1 meter), is not the actual length but the represented length (read the article again). Poor design can be represented by a large length. This situation can be found throughout the die casting industry due to the ‘‘common’’ model which does not consider runner design. My office is full with runner designs with represent 1 meter length such as one which got NADCA's design award².

In regards to the area ratio, please compare with the other referee who claim $A_3/A_2 = 0.8 - 0.95$. I am not sure which of you really represent NADCA's position (I didn't find any of NADCA's publication in regards to this point). I do not agree with both referees. This value has to be calculated and cannot be speculated as the referees asserted. Please find an explanation to this point in the paper or in even better in Chapter 7.

A.3 Referee 2

There are several major concerns I have about this paper. The [most] major one [of these] is that [it] is unclear what the paper is attempting to accomplish. Is the paper trying to suggest a new way of designing the rigging for a die casting, or is it trying to add an improvement to the conventional pQ^2 solution, or is it trying to somehow suggest a ‘mathematical basis for the pQ^2 diagram’?

The paper shows that 1) the ‘‘conventional pQ^2 solution’’ is totally wrong, 2) the mathematical analytical solution for the pQ^2 provides an excellent tool for studying the effect of various parameters.

The other major concern is the poor organization of the ideas which the authors [are] trying to present. For instance, it is unclear how specific results presented in the results section where obtained ([for instance] how were the results in Figures 5 and 6 calculated?).

I do not understand how the organization of the paper relates to the fact that the referee does not understand how Fig 5 and 6 were calculated. The

²to the best of my understanding

Section A.3. Referee 2

organization of the paper does not have anything to do with his understanding of the concepts presented. In regard to the understanding of how Figure 5 and 6 were obtained, the referee should refer to an elementary fluid mechanics text book and combine it with the explanation presented in the paper.

Several specific comments are written on the manuscript itself; most of these were areas where the reviewer was unclear on what the authors meant or areas where further discussion was necessary. One issue that is particularly irksome is the authors' tendency in sections 1 and 2 to wander [wander] off with "editorials" and other unsupported comments which have no place in a technical article.

Please show me even one unsupported comment!!

Other comments/concerns include-

- what does the title have to do with the paper? The paper does not define what a pQ² diagram is and the results don't really tie in with the use of such diagrams.

The paper presents the exact analytical solution for the pQ² diagram. The results tie in very well with the correct pQ² diagram. Unfortunately, the 'common' model is incorrect and so the results cannot be tied in with it.

- p.4 The relationship $Q \propto \sqrt{P}$ is a result of the application of Bernoulli's equation system like that shown in Fig 1. What is the rationale or basis behind equation 1; e.g. $Q \propto (1 - P)^n$ with $n = 1, 1/2, \text{ and } 1/4$?

Here I must thank the referee for his comment! If the referee had serious problem understanding this point, I probably should have considered adding a discussion about this point, such as in Chapter 7.

- p.5 The relationship between equation 1(a) to 1(c) and a die casting machine as "poor", "common", and "excellent" performance is not clear and needs to be developed, or at least defined.

see previous comment

- It is well known that C_D for a die casting machine and die is not a constant. In fact it is common practice to experimentally determine C_D for use on dies with 'similar' gating layouts in the future. But because most dies have numerous gates branching off of numerous runners, to determine all of the friction factors as a function of Reynolds number would be quite difficult and virtually untractable for design purposes. Generally die casting engineers find conventional pQ² approach works quite well for design purposes.

This 'several points' comment gives me the opportunity to discuss the following points:

- ★ I would kindly ask the referee, to please provide the names of any companies whom “experimentally determine C_D .” Perhaps they do it down under (Australia) where the “regular” physics laws do not apply (please, forgive me about being the cynical about this point. I cannot react to this any other way.). Please, show me a company that uses the “common” pQ^2 diagram and it works.
- ★ Due to the computer revolution, today it is possible to do the calculations of the C_D for a specific design with a specific flow rate (die casting machine). In fact, this is exactly what this paper all about. Moreover, today there is a program that already does these kind of calculations, called DiePerfect™.
- ★ Here the referee introduce a new idea of the “family” -- the improved constant C_D . In essence, the idea of “family” is improve constant C_D in which one assigned value to a specific group of runners. Since this idea violate the basic physics laws and the produces the opposite to realty trends it must be abandoned. Actually, the idea of “family” is rather bizarre, because a change in the design can lead to a significant change in the value of C_D . Furthermore, the “family” concept can lead to a poor design (read about this in the section “poor design effects” of this book). How one can decided which design is part of what “family”? Even if there were no mistakes, the author’s method (calculating the C_D) is of course cheaper and faster than the referee’s suggestion about “family” of runner design. In summary, this idea a very bad idea.
- ★ What is C_D =constant? The referee refers to the case where C_D is constant for specific runner design but which is not the case in reality. The C_D does not depend only on the runner, but on the combination of the runner system with the die casting machine via the Re number. Thus, a specific runner design cannot have C_D “assigned” to it. The C_D has to be calculated for any combination runner system with die casting machine.
- ★ I would like to find any case where the “common” pQ^2 diagram does work. Please read the proofs in Chapter 7 showing why it cannot work.

- Discussion and results A great deal of discussion focuses on the regions where A_3/A_2 0.1; yet in typical die casting dies A_3/A_2 0.8 to 0.95.

Please read the comments to the previous referee

In conclusion, it's just a plain sloppy piece of work

I hope that referee does not mind that I will use it as the chapter quote.

(the Authors even have one of the references to their own publications sited incorrectly!).

Perhaps, the referee should learn that magazines change names and, that the name appears in the reference is the magazine name at the time of writing the paper.

A.4 Referee 3

The following comments are not arranged in any particular order.

General: The text has a number of errors in grammar, usage and spelling that need to be addressed before publication.

p 6 1st paragraph - The first sentence says that the flow rate is a function of temperature, yet the rest of the paragraph says that it isn't.

The rest of the paragraph say the flow rate is a weak function of the temperature and that it explains why. I hope that everyone agrees with me that it is common to state a common assumption and explain why in that particular case it is not important. I wish that more people would do just that. First, it would eliminate many mistakes that are synonymous with research in die casting, because it forces the "smart" researchers to check the major assumptions they make. Second, it makes clear to the reader why the assumption was made.

p 6 - after Eq 2 - Should indicate immediately that the subscript[s] refer to the sections in Figure 1.

I will consider this, Yet, I am not sure this is a good idea.

p 6 - after equation 2 - There is a major assumption made here that should not pass without some comment[s]³ "Assuming steady state" - This assumption goes to the heart of this approach to the filling calculation and establishes the bounds of its applicability. The authors should discuss this point.

Well, I totally disagree with the referee on this point. The major question in die casting is how to ensure the right range of filling time and gate velocity. This paper's main concern is how to calculate the C_p and determine if the C_p be "assigned" to a specific runner. The unsteady state is only a side effect and has very limited importance due to AESS. Of course the flow is not continuous/steady state and is affected by many parameters such as the piston weight, etc, all of which are related to the transition point and not to the pQ^2 diagram per se. The unsteady state exists only in the initial and final stages of the injection. As a general rule, having a well designed pQ^2 diagram will produce a significant improvement in the process design. It should be noted that a full paper discussing the unsteady state is being prepared for publication at the present time.

³Is the referee looking for one or several explanations?

In general the organization of the paper is somewhat weak - the introduction especially does not very well set the technical context for the pQ^2 method and show how the present work fits into it.

The present work does not fit into past work! It shows that the past work is wrong, and builds the mathematical theory behind the pQ^2 diagram.

The last paragraph of the intro is confused [confusing]. The idea introduced in the last sentence on page 2 is that the CD should vary somehow during the calculation, and subsequently variation with Reynolds number is discussed, but the intervening material about geometry effects is inconsistent with a discussion of things that can vary during the calculation. The last two sentences do not fit together well either - "the assumption of constant CD is not valid" - okay, but is that what you are going to talk about, or are you going to talk about "particularly the effects of the gate area"?

Firstly, C_D should not vary during the calculations it is a constant for a specific set of runner system and die casting machine. Secondly, once any parameter is changed, such as gate area, C_D has to be recalculated. Now the referee's statement C_D should vary, isn't right and therefore some of the following discussion is wrong.

Now about the fitting question. What do referee means by "fit together?" Do the paper has to be composed in a rhyming verse? Anyhow, geometrical effects are part of Reynolds number (review fluid mechanics). Hence, the effects of the gate area shows that C_D varies as well and has to be recalculated. So what is inconsistent? How do these sentences not fit together?

On p 8, after Eq 10 - I think that it would be a good idea to indicate immediately that these equations are plotted in Figure 3, rather than waiting to the next section before referring to Fig 3.

Also, making the Oz-axis on this graph logarithmic would help greatly in showing the differences in the three pump characteristics.

Mentioning the figure could be good idea but I don't agree with you about the log scale, I do not see any benefits.

On p. 10 after Eq 11 - The solution of Eq 11 requires full information on the die casting machine - According to this model, the machine characterized by P_{max} , Q_{max} and the exponent in Eq 1. The wording of this sentence, however, might be indicating that there is some information to be had on the machine other that these three parameters. I do not think that that is what the authors intend, but this is confusing.

This is exactly what the authors intended. The model does not confined to a specific exponent or function, but rather gives limiting cases. Every die casting machine can vary between the two extreme functions, as discussed in the paper. Hence, more information is needed for each individual die casting machine.

p 12 - I tend to disagree with the premises of the discussion following Eq 12. I think that Q_{max} depends more strongly on the machine size than does P_{max} . In general, P_{max} is the intensification pressure that one wants to achieve during solidification, and this

should not change much with the machine size, whereas the clamping force, the product of this pressure and platten area, goes up. On the other hand, when one has larger area to make larger casting, one wants to increase the volumetric flow rate of metal so that flow rate of metal so that fill times will not go up with the machine size. Commonly, the shot sleeve is larger, while the maximum piston velocity does not change much.

Here the referee is confusing so many different concepts that it will take a while to explain it properly. Please find here a attempt to explain it briefly. The intensification pressure has nothing to do with the pQ^2 diagram. The pQ^2 does not have much to do with the solidification process. It is designed not to have much with the solidification. The intensification pressure is much larger than P_{max} . I give up!! It would take a long discussion to teach you the fundamentals of the pQ^2 diagram and the die casting process. You confuse so many things that it impossible to unravel it all for you in a short paragraph. Please read Chapter 7 or even better read the whole book.

Also, following Eq 13, the authors should indicate what they mean by "middle range" of the Oz numbers. It is not clear from Fig 3 how close one needs to get to $Oz=0$ for the three curves to converge again.

The mathematical equations are given in the paper. They are very simple that you can use hand calculator to find how much close you need to go to $Oz = 0$ for your choice of error. A discussion on such issue is below the level from an academic paper.

Besides being illustrative of the results, part of the value of an example calculation comes from it making possible duplication of the results elsewhere. In order to support this, the authors need to include the relationships that used for CD in these calculations.

The literature is full of such information. If the referee opens any basic fluid mechanics text book then he can find information about it.

The discussion on p 14 of Fig 5 needs a little more consideration. There is a maximum in this curve, but the author's criterion of being on the "right hand branch" is said to be shorter fill time, which is not a criterion for choosing a location on this curve at all. The fill time is monotone decreasing with increasing $A3$ at constant $A2$, since the flow is the product of V_{max} and $A3$. According to this criterion, no calculation is needed - the preferred configuration is no gate whatsoever. Clearly, choosing an operating point requires introduction of other criteria, including those that the authors mention in the intro. And the end of the page 14 discussion that the smaller filling time from using a large gate (or a smaller runner!?!?) will lead to a smaller machine just does not follow at all. The machine size is determined by the part size and the required intensification pressure, not by any of this.

Once again the referee is confusing many issues; let me interpret again what is the pQ^2 diagram is all about. The pQ^2 diagram is for having an operational point at the right gate velocity and the right filling time. For any given A_2 , there are two possible solutions on the right hand side

and one on the left hand side with the same gate velocity. However, the right hand side has smaller filling time.

And again, the referee confusing another issue. Like in many engineering situations, we have here a situation in which more than one criterion is needed. The clamping force is one of the criteria that determines what machine should be chosen. The other parameter is the pQ^2 diagram.

It seems that they authors have obscured some elementary results by doing their calculations.⁴

For example, the last sentence of the middle paragraph on p 15 illustrates that as C_D reaches its limiting value of 1, the discharge velocity reaches its maximum. This is not something we should be publishing in 1998.

There is no mention of the alleged fact of “ C_D reaches its limiting value of 1.” There is no discussion in the whole article about “ C_D reaching its maximum ($C_D=1$)”. Perhaps the referee was mistakenly commenting on different articles (NADCA's book or an other die casting book) which he has confused with this article.

Regarding the concluding paragraph on p 15:

1. The use of the word “constant” is not consistent throughout this paper. Do they mean constant across geometry or constant across Reynolds number, or both.

To the readers: The referee means across geometry as different geometry and across Reynolds number as different Re number⁵. I really do not understand the difference between the two cases. Aren't actually these cases the same? A change in geometry leads to a change in Reynolds number number. Anyhow, the referee did not consider a completely different possibility. Constant C_D means that C_D is assigned to a specific runner system, or like the “common” model in which all the runners in the world have the same value.

2. Assuming that they mean constant across geometry, then obviously, using a fixed value for all runner/gate systems will sometimes lead to large errors. They did not need to do a lot calculation to determine this.

And yet this method is the most used method in the industry(some even will say the exclusive method).

3. Conversely, if they mean constant across Reynolds number, i.e. C_D can vary through the run as the velocity varies, then they have not made their case very well. Since they have assumed steady state and the $P3$ does not enter into the

⁴If it is so elementary how can it be obscured.

I have broken-out this paragraph for purposes of illustration.

⁵if the interpretation is not correct I would like to learn what it really mean.

calculation, then the only reason that mention for the velocity to vary during the fill would be because K_f varies as a function of the fill fraction. They have not developed this argument sufficiently.

Let me stress again the main point of the article. C_D varies for different runners and/or die casting machines. It is postulated that the velocity does not vary during run. A discussion about P_3 is an entirely different issue related to the good venting design for which P_3 remains constant.

4. If the examples given in the paper do not represent the characteristics of a typical die casting machine, why to present them at all? Why are the “more detailed calculations” not presented, instead of the trivial results that are shown?

These examples demonstrate that the “common” method is erroneous and that the “authors’” method should be adopted or other methods based on scientific principles. I believe that this is a very good reason.

APPENDIX B

My Relationship with Die Casting Establishment

I cannot believe the situation that I am in. The hostility I am receiving from the establishment is unbelievable, as individual who has spent the last 12 years in research to improve the die casting. At first I was expecting to receive a welcome to the club. Later when my illusions disappeared, I realized that it revolves around money along with avoiding embarrassment to the establishment due to exposing of the truths and the errors the establishment has sponsored. I believe that the establishment does not want people to know that they had invested in research which produces erroneous models and continues to do so, even though they know these research works/models are scientifically rubbish. They don't want people to know about their misuse of money.

When I started my research, I naturally called what was then SDCE. My calls were never returned. A short time later SDCE developed into what is now called NADCA. I had hoped that this new creation would prove better. Approximately two years ago I wrote a letter to Steve Udvardy, director of research and education for NADCA (a letter I never submitted). Now I have decided that it is time to send the letter and to make it open to the public. I have a long correspondence with Paul Bralower, former director of communication for NADCA, which describes my battle to publish important information. An open letter to Mr. Baran, Director of Marketing for NADCA, is also attached. Please read these letters. They reveal a lot of information about many aspects of NADCA's operations. I have submitted five (5) articles to this conference (20th in Cleveland) and only one was accepted (only 20% acceptance compared to ~ 70% to any body else). Read about it here. During my battle to "insert" science in die casting, many curious things have taken place and I wonder: are they coincidental? Read about these and please let me know what you think.

Open Letter to Mr. Udvardy

Steve Udvardy NADCA,
9701 West Higgins Road, Suite 880
Rosemont, IL 60018-4721

January 26, 1998

Subject: Questionable ethics

Dear Mr. Udvardy:

I am writing to express my concerns about possible improprieties in the way that NADCA awards research grants. As a NADCA member, I believe that these possible improprieties could result in making the die casting industry less competitive than the plastics and other related industries. If you want to enhance the competitiveness of the die casting industry, you ought to support die casting industry ethics and answer the questions that are raised herein.

Many of the research awards raise serious questions and concerns about the ethics of the process and cast very serious shadows on the integrity those involved in the process. In the following paragraphs I will spell out some of the things I have found. I suggest to you and all those concerned about the die casting industry that you/they should help to clarify these questions, and eliminate other problems if they exist in order to increase the die casting industry's profits and competitiveness with other industries. I also wonder why NADCA demonstrates no desire to participate in the important achievements I have made.

On September 26, 1996, I informed NADCA that Garber's model on the critical slow plunger velocity is unfounded, and, therefore so, is all the other research based on Garber's model (done by Dr. Brevick from Ohio State University). To my great surprise I learned from the March/April 1997 issue of Die Casting Engineer that NADCA has once again awarded Dr. Brevick with a grant to continue his research in this area. Also, a year after you stated that a report on the results from Brevick's could be obtained from NADCA, no one that I know of has been able to find or obtain this report. I and many others have tried to get this report, but in vain. It leaves me wondering whether someone does not want others to know about this research. I will pay \$50 to the first person who will furnish me with this report. I also learned (in NADCA's December 22, 1997 publication) that once more NADCA awarded Dr. Brevick with another grant to do research on this same topic for another budget year (1998). Are Dr. Brevick's results really that impressive? Has he changed his model? What is the current model? Why have we not heard about it?

I also learned in the same issue of Die Casting Engineer that Dr. Brevick and his colleagues have been awarded another grant on top of the others to do research on the topic entitled "Development and Evaluation of the Sensor System." In the September/October 1997 issue, we learned that Mr. Gary Pribyl, chairman of the NADCA Process Technology Task Group, is part of the research team. This Mr. Pribyl is the chairman of the very committee which funded the research. Of course, I am sure, this could not be. I just would like to hear your explanation. Is it legitimate/ethical to have a man on the committee awarding the chairman a grant?

Working on the same research project with this Mr. Pribyl was Dr. Brevick who also

received a grant mentioned above. Is there a connection between the fact that Gary Pribyl cooperated with Dr. B. Brevick on the sensor project and you deciding to renew Dr. Brevick's grant on the critical slow plunger velocity project? I would like to learn what the reasoning for continuing to fund Dr. Brevick after you had learned that his research was problematic.

Additionally, I learned that Mr. Steve Udvardy was given a large amount of money to study distance communications. I am sure that Mr. Udvardy can enhance NADCA's ability in distance learning and that this is why he was awarded this grant. I am also sure that Mr. Udvardy has all the credentials needed for such research. One can only wonder why his presentation was not added to the NADCA proceedings. One may also wonder why there is a need to do such research when so much research has already been done in this area by the world's foremost educational experts. Maybe it is because distance communication works differently for NADCA. Is there a connection between Mr. Steve Udvardy being awarded this grant and his holding a position as NADCA's research director? I would like to learn the reasons you vouchsafe this money to Mr. Udvardy! I also would like to know if Mr. Udvardy's duties as director of education include knowledge and research in this area. If so, why is there a need to pay Mr. Udvardy additional monies to do the work that he was hired for in the first place?

We were informed by Mr. Walkington on the behalf of NADCA in the Nov–Dec 1996 issue that around March or April 1997, we would have the software on the critical slow plunger velocity. Is there a connection between this software's apparent delayed appearance and the fact that the research in Ohio has produced totally incorrect and off–base results? I am sure that there are reasons preventing NADCA from completing and publishing this software; I would just like to know what they are. I am also sure that the date this article came out (Nov/Dec 1996) was only coincidentally immediately after I sent you my paper and proposal on the shot sleeve (September 1996). What do you think?

Likewise, I learned that Mr. Walkington, one of the governors of NADCA, also received a grant. Is there a connection between this grant being awarded to Mr. Walkington and his position? What about the connection between his receiving the grant and his former position as the director of NADCA research? I am sure that grant was awarded based on merit only. However, I have serious concerns about his research. I am sure that these concerns are unfounded, but I would like to know what Mr. Walkington's credentials are in this area of research.

The three most important areas in die casting are the critical slow plunger velocity, the pQ^2 diagram, and the runner system design. The research sponsored by NADCA on the critical slow plunger velocity is absolutely unfounded because it violates the basic physics laws. The implementation of the pQ^2 diagram is also absolutely unsound because again, it violates the basic physics laws. One of the absurdities of the previous model is the idea that plunger diameter has to decrease in order to increase the gate velocity. This conclusion (of the previous model) violates several physics laws. As a direct consequence, the design of the runner system (as published in NADCA literature) is, at best, extremely wasteful.

As you also know, NADCA, NSF, the Department of Energy, and others sponsoring research in these areas exceed the tens of millions, and yet produce erroneous results. I am the one who discovered the correct procedure in both areas. It has been my

continuous attempt to make NADCA part of these achievements. Yet, you still have not responded to my repeated requests for a grant. Is there a reason that it has taken you $1\frac{1}{2}$ years to give me a negative answer? Is there a connection between any of the above information and how long it has taken you?

Please see the impressive partial-list of the things that I have achieved. I am the one who found Garber's model to be totally and absolutely wrong. I am also the one responsible for finding the pQ^2 diagram implementation to be wrong. I am the one who is responsible for finding the correct pQ^2 diagram implementation. I am the one who developed the critical area concept. I am the one who developed the economical runner design concept. In my years of research in the area of die casting I have not come across any research that was sponsored by NADCA which was correct and/or which produced useful results!! Is there any correlation between the fact that all the important discoveries (that I am aware of) have been discovered not in-but outside of NADCA? I would like to hear about anything in my area of expertise supported by NADCA which is useful and correct? Is there a connection between the foregoing issues and the fact that so many of the die casting engineers I have met do not believe in science?

More recently, I have learned that your secretary/assistant, Tricia Margel, has now been awarded one of your grants and is doing research on pollution. I am sure the grant was given based on qualification and merit only. I would like to know what Ms. Margel's credentials in the pollution research area are? Has she done any research on pollution before? If she has done research in that area, where was it published? Why wasn't her research work published? If it was published, where can I obtain a copy of the research? Is this topic part of Ms. Margel's duties at her job? If so, isn't this a double payment? Or perhaps, was this an extra separated payment? Where can I obtain the financial report on how the money was spent?

Together we must promote die casting knowledge. I am doing my utmost to increase the competitiveness of the die casting industry with our arch rivals: the plastics industry, the composite material industry, and other industries. I am calling on everyone to join me to advance the knowledge of the die casting process.

Thank you for your consideration.

Sincerely,

Genick Bar-Meir, Ph.D.

cc: NADCA Board of Governors
NADCA members
Anyone who care about die casting industry

Correspondence with Paul Bralower

Paul Bralower is the former director of communications at NADCA. I have tried to publish articles about critical show shot sleeve and the pQ^2 diagram through NADCA magazine. Here is an example of my battle to publish the article regarding pQ^2 . You judge whether NADCA has been enthusiastic about publishing this kind of information. Even after Mr. Bralower said that he would publish it I had to continue my struggle.

He agreed to publish the article but . . .

At first I sent a letter to Mr. Bralower (Aug 21, 1997):

Paul M. Bralower
NADCA, Editor
9701 West Higgins Road, Suite 880
Rosemont, IL 60018-4721

Dear Mr. Bralower:

Please find enclosed two (2) copies of the paper "The mathematical theory of the pQ^2 diagram" submitted by myself for your review. This paper is intended to be considered for publication in *Die Casting Engineer*.

For your convenience I include a disk DOS format with Microsoft WORD for window format (pq2.wid) of the paper, postscript/pict files of the figures (figures 1 and 2). If there is any thing that I can do to help please do not hesitate let me know.

Thank you for your interest in our work.

Respectfully submitted,
Dr. Genick Bar-Meir

cc: Larry Winkler
a short die casting list

encl: Documents,
Disk

He did not responded to this letter, so I sent him an additional one on December 6, 1997.

Paul M. Bralower
NADCA, Editor
9701 West Higgins Road, Suite 880
Rosemont, IL 60018-4721

Dear Mr. Bralower:

I have not received your reply to my certified mail to you dated August 20, 1997 in which I enclosed the paper "The mathematical theory of the pQ^2 diagram" authored by myself for your consideration (a cc was also sent to Larry Winkler from Hartzell). Please consider publishing my paper in the earliest possible issue. I believe that this paper is of extreme importance to the die casting field.

I understand that you have been very busy with the last exhibition and congress.

However, I think that this paper deserves a prompt hearing.

I do not agree with your statement in your December 6, 1996 letter to me stating that "This paper is highly technical-too technical without a less-technical background

explanation for our general readers I do not believe that discounting your readers is helpful. I have met some of your readers and have found them to be very intelligent, and furthermore they really care about the die casting industry. I believe that they can judge for themselves. Nevertheless, I have yielded to your demand and have eliminated many of the mathematical derivations from this paper to satisfy your desire to have a "simple" presentation. This paper, however, still contains the essentials to be understood clearly. Please note that I will withdraw the paper if I do not receive a reply stating your intentions by January 1, 1998, in writing. I do believe this paper will change the way pQ^2 diagram calculations are made. The pQ^2 diagram, as you know, is the central part of the calculations and design thus the paper itself is of same importance.

I hope that you really do see the importance of advancing knowledge in the die casting industry, and, hope that you will cooperate with those who have made the major progress in this area.

Thank you for your consideration.

Sincerely,

Dr. Genick Bar-Meir

cc: Boxter, McClimtic, Scott, Wilson, Holland, Behler, Dupre, and some other NADCA members

ps: You probably know by now that Garber's model is totally and absolutely wrong including all the other investigations that were based on it, even if they were sponsored by NADCA. (All the researchers agreed with me in the last congress)

Well that letter got him going and he managed to get me a letter in which he claim that he sent me his revisions. Well, read about it in my next letter dated January 7, 1998.

Paul M. Bralower,
NADCA, Editor
9701 West Higgins Road, Suite 880
Rosemont, IL 60018-4721

Dear Mr. Bralower:

Thank you for your fax dated December 29, 1997 in which you alleged that you sent me your revisions to my paper "The mathematical theory of the pQ^2 diagram." **I never receive any such thing!!** All the parties that got this information and myself find this paper to of extreme importance.

I did not revise my paper according to your comments on this paper, again, since I did not receive any. I decided to revised the paper since I did not received any reply from you for more than 4 months. I revised according to your comments on my previous paper on the critical slow plunger velocity. As I stated in my letter dated December 6, 1997, I sent you the revised version as I send to all the cc list. I re-sent you the same version on December 29, 1997. Please note that this is the last time I will send you the same paper since I believe that you will claim again that you do not receive any of my submittal. In case that you claim again that you did not receive the paper you can get a copy from anyone who is on the cc list. Please be aware that I changed the title of the paper (December, 6, 1997 version) to be "How to calculate the pQ^2 diagram correctly".

I would appreciate if you respond to my e-Mail by January 14, 1998. Please consider this paper withdrawn if I will not hear from you by the mentioned date in writing (email is fine) whether the paper is accepted.

I hope that you really do see the importance of advancing knowledge in the die casting industry, and, hope that you will cooperate with those who have made the major progress in this area.

Sincerely,
Dr. Genick Bar-Meir

ps: You surely know by now that Garber's model is totally and absolutely wrong including all the other investigations that where based on it

He responded to this letter and changed his attitude ... I thought.

January 9, 1998.

Dear Mr. Bar-Meir:

Thank you for your recent article submission and this follow-up e-mail. I am now in possession of your article "How to calculate the pQ2 diagram correctly." It is the version dated Jan. 2, 1998. I have read it and am prepared to recommend it for publication in Die Casting Engineer. I did not receive any earlier submissions of this article, I was confusing it with the earlier article that I returned to you. My apologies. However I am very pleased at the way you have approached this article. It appears to provide valuable information in an objective manner, which is all we have ever asked for. As is my policy for highly technical material, I am requesting technical personnel on the NADCA staff to review the paper as well. I certainly think this paper has a much better chance of approval, and as I said, I will recommend it. I will let you know of our decision in 2-3 weeks. Please do not withdraw it—give us a little more time to review it! I would like to publish it and I think technical reviewer will agree this time.

Sincerely,
Paul Bralower

Well I waited for a while and then I sent Mr. Bralower a letter dated Feb 2, 1998.

Dear Mr. Bralower,

Apparently, you do not have the time to look over my paper as you promise. Even a negative reply will demonstrate that you have some courtesy. But apparently the paper is not important as your experts told you and I am only a small bothering cockroach.

Please see this paper withdrawn!!!!

I am sorry that we do not agree that an open discussion on technical issues should be done in your magazine. You or your technical experts do not have to agree with my research. I believe that you have to let your readers to judge. I am sure that there is no other reasons to your decision. I am absolutely sure that you do not take into your consideration the fact that NADCA will have to stop teaching SEVERAL COURSES which are wrong according to this research.

Thank you for your precious time!!

Dr. Bar-Meir

Please note that this letter and the rest of the correspondence with you in this matter will be circulated in the die casting industry. I am sure that you stand by your decision and you would like other to see this correspondence even if they are NADCA members.

Here is the letter I received in return a letter from Paul Bralower Feb 5, 1998.

Dear Mr. Bar-Meir:

I'll have you know that you have inconvenienced me and others on our staff today with your untoward, unnecessary correspondence. If you had a working telephone or fax this e-mail would not be necessary. As it is I must reply to your letter and take it to someone else's office and have them e-mail it to you right away.

I tried to telephone you last week on Thurs. 1/29 with the news that we have agreed to publish your article, "How to Calculate the pQ^2 diagram correctly." I wanted to ask you to send the entire paper, with graphics and equations, on a disk. Because of the current status of our e-mail system, I would advise you not to e-mail it. Send it on any of the following: Syquest, Omega ZIP or Omega JAZ. Use Microsoft Office 97, Word 6.0 or Word Perfect 6.0.

The problem is I couldn't reach you by phone. I tried sending you a fax several times Thurs. and last Friday. There was no response. We tried a couple of different numbers that we had for you. Having no response, I took the fax and mailed it to you as a letter on Monday 2/2. I sent Priority 2-day Mail to your attention at Innovative Filters, 1107 16th Ave. S.E., Minneapolis, Minn, 55414. You should have received it today at latest if this address is correct for you, which it should be since it was on your manuscript.

Now, while I'm bending over backwards to inform you of your acceptance, you have the nerve to withdraw the paper and threaten to spread negative gossip about me in the industry! I know you couldn't have known I was trying to contact you, but I must inform you that I can't extend any further courtesies to you. As your paper has been accepted, I expect that you will cancel your withdrawl and send me the paper on disk immediately for publication. If not, please do not submit any further articles.

My response to Paul M. Bralower.

Feb 9, 1998

Dear Mr. Bralower:

Thank you for accepting the paper "How to calculate the pQ^2 diagram correctly". I strongly believe that this paper will enhance the understanding of your readers on this central topic. Therefore, it will help them to make wiser decisions in this area, and thus increase their productivity. I would be happy to see the paper published in Die Casting Engineer.

As you know I am zealous for the die casting industry. I am doing my utmost to promote the knowledge and profitability of the die casting industry. I do not apologize for doing so. The history of our correspondence makes it look as if you refuse to publish important information about the critical slow plunger velocity. The history shows that you lost this paper when I first sent it to you in August, and also lost it when I resubmitted it in early December. This, and the fact that I had not heard from you by February 1, 1998, and other information, prompted me to send the email I sent. I am sure that if you were in my shoes you would have done the same. My purpose was not to insults anyone. My only

aim is to promote the die casting industry to the best of my ability. I believe that those who do not agree with promoting knowledge in die casting should not be involved in die casting. I strongly believe that the editor of NADCA magazine (Die Casting Engineer) should be interested in articles to promote knowledge. So, if you find that my article is a contribution to this knowledge, the article should be published.

I do not take personal insult and I will be glad to allow you to publish this paper in Die Casting Engineer. I believe that the magazine is an appropriate place for this article. To achieve this publication, I will help you in any way I can. The paper was written using \LaTeX , and the graphics are in postscript files. Shortly, I will send you a disc containing all the files. I will also convert the file to Word 6.0. I am afraid that conversion will require retyping of all the equations. As you know, WORD produces low quality setup and requires some time. Would you prefer to have the graphic files to be in TIFF format? or another format? I have enhanced the calculations resolution and please be advised that I have changed slightly the graphics and text.

Thank you for your assistance.

Sincerely,

Dr. Genick Bar-Meir

Is the battle over?

Well, I had thought in that stage that the paper would finally be published as the editor had promised. Please continue to read to see how the saga continues.

4/24/98

Dear Paul Bralower:

To my great surprise you did not publish my article as you promised. You also did not answer my previous letter. I am sure that you have a good reasons for not doing so. I just would like to know what it is. Again, would you be publishing the article in the next issue? any other issue? published at all? In case that you intend to publish the article, can I receive a preprint so I can proof-read the article prior to the publication?

Thank you for your consideration and assistance!!

Genick

Then I got a surprise: the person dealing with me was changed. Why? (maybe you, the reader, can guess what the reason is). I cannot imagine if the letter was an offer to buy me out. I just wonder why he was concerned about me not submitting proposals (or this matter of submitting for publication). He always returned a prompt response to my proposals, yah sure. Could he possibly have suddenly found my research to be so important. Please read his letter, and you can decide for yourself.

Here is Mr. Steve Udvardy response on Fri, 24 Apr 1998

Genick,

I have left voice mail for you. I wish to speak with you about what appears to be non-submittal of your proposal I instructed you to forward to CMC for the 1999 call.

I can and should also respond to the questions you are posinjc to Paul.

I can be reached by phone at 219.288.7552.

Thank you,
Steve Udvardy

Since the deadline for that proposal had passed long before, I wondered if there was any point in submitting any proposal. Or perhaps there were exceptions to be made in my case? No, it couldn't be; I am sure that he was following the exact procedure. So, I then sent Mr. Udvardy the following letter.

April 28, 1998

Dear Mr. Udvardy:

Thank you very much for your prompt response on the behalf of Paul Bralower. As you know, I am trying to publish the article on the pQ^2 diagram. I am sure that you are aware that this issue is central to die casting engineers. A better design and a significant reduction of cost would result from implementation of the proper pQ^2 diagram calculations.

As a person who has dedicated the last 12 years of his life to improve the die casting industry, and as one who has tied his life to the success of the die casting industry, I strongly believe that this article should be published. And what better place to publish it than "Die Casting Engineer"?

I have pleaded with everyone to help me publish this article. I hope that you will agree with me that this article should be published. If you would like, I can explain further why I think that this article is important.

I am very glad that there are companies who are adopting this technology. I just wish that the whole industry would do the same.

Again, thank you for your kind letter.

Genick

ps: I will be in my office Tuesday between 9-11 am central time (612) 378-2940

I am sure that Mr. Udvardy did not receive the comments of/from the referees (see Appendix A). And if he did, I am sure that they did not do have any effect on him whatsoever. Why should it have any effect on him? Anyhow, I just think that he was very busy with other things so he did not have enough time to respond to my letter. So I had to send him another letter.

5/15/98

Dear Mr. Udvardy:

I am astonished that you do not find time to answer my letter dated Sunday, April, 26 1998 (please see below copy of that letter). I am writing you to let you that there is a serious danger in continue to teach the commonly used pQ^2 diagram. As you probably know (if you do not know, please check out IFI's web site www.dieperfect.com), the commonly used pQ^2 diagram as it appears in NADCA's books violates the first and the second laws of thermodynamics, besides numerous other common sense things. If NADCA teaches this material, NADCA could be liable for very large sums of money to the students who have taken these courses. As a NADCA member, I strongly recommend that these classes be suspended until the instructors learn the correct procedures. I, as a

NADCA member, will not like to see NADCA knowingly teaching the wrong material and moreover being sued for doing so.

I feel that it is strange that NADCA did not publish the information about the critical slow plunger velocity and the pQ^2 diagram and how to do them correctly. I am sure that NADCA members will benefit from such knowledge. I also find it beyond bizarre that NADCA does not want to cooperate with those who made the most progress in the understanding die casting process. But if NADCA teaching the wrong models might end up being suicidal and I would like to change that if I can.

Thank you for your attention, time, and understanding!

Sincerely, Dr. Genick Bar-Meir

ps: Here is my previous letter.

Now I got a response. What a different tone. Note the formality (Dr Bar-Meir as oppose to Genick).

May 19, 1998

Dear Dr Bar-Meir,

Yes, I am here. I was on vacation and tried to contact you by phone before I left for vacation. During business travel, I was sorry to not be able to call during the time period you indicated.

As Paul may have mentioned, we have approved and will be publishing your article on calculating PQ^2 . The best fit for this is an upcoming issue dedicated to process control.

Please rest assured that it will show up in this appropriate issue of DCE magazine.

Since there has been communications from you to Paul and myself and some of the issues are subsequently presented to our Executive Vice President, Dan Twarog, kindly direct all future communications to him. This will assist in keeping him tied in the loop and assist in getting responses back to you. His e-mail address is Twarog@diecasting.org.

Thank you,
Steve Udvardy

Why does Mr. Udvardy not want to communicate with me and want me to write to Executive Vice President? Why did they change the title of the article and omit the word "correctly". I also wonder about the location in the end of the magazine.

I have submitted other proposals to NADCA, but really never received a reply. Maybe it isn't expected to be replied to? Or perhaps it just got/was lost?

Open letter to Leo Baran

In this section an open letter to Leo Baran is presented. Mr. Baran gave a presentation in Minneapolis on May 12, 1999, on "Future Trends and Current Projects" to "sell" NADCA to its members. At the conclusion of his presentation, I asked him why if the situation is so rosy as he presented, that so many companies are going bankrupt and sold. I proceeded to ask him why NADCA is teaching so many erroneous models. He gave me Mr. Steve Udvardy's

business card and told me that he has no knowledge of this and that since he cannot judge it, he cannot discuss it. Was he prepared for my questions or was this merely a spontaneous reaction?

Dear Mr. Baran,

Do you carry Steve Udvardy's business card all the time? Why? Why do you not think it important to discuss why so many die casting companies go bankrupt and are sold? Is it not important for us to discuss why there are so many financial problems in the die casting industry? Don't you want to make die casting companies more profitable? And if someone tells you that the research sponsored by NADCA is rubbish, aren't you going to check it? Discuss it with others in NADCA? Don't you care whether NADCA teaches wrong things? Or is it that you just don't give a damn?

I am sure that it is important for you. You claimed that it is important for you in the presentation. So, perhaps you care to write an explanation in the next NADCA magazine. I would love to read it.

Sincerely,

Genick Bar-Meir

Is it all coincidental?

I had convinced Larry Winkler in mid 1997 (when he was still working for Hartzell), to ask Mr. Udvardy why NADCA continued support for the wrong models (teaching the erroneous Garber's model and fueling massive grants to Ohio State University). He went to NADCA and talked to Mr. Udvardy about this. After he came back, he explained that they told him that I didn't approach NADCA in the right way. (what is that?) His enthusiasm then evaporated, and he continues to say that, because NADCA likes evolution and not revolution, they cannot support any of my revolutionary ideas. He suggested that I needed to learn to behave before NADCA would ever cooperate with me. I was surprised and shaken. "What happened, Larry?" I asked him. But I really didn't get any type of real response. Later (end of 1997) I learned he had received NADCA's design award. You, the reader, can conclude what happened; I am just supplying you with the facts.

Several manufacturers of die casting machines, Buler, HPM, Prince, and UBE presented their products in Minneapolis in April 1999. When I asked them why they do not adapt the new technologies, with the exception of the Buler, the response was complete silence. And just Buler said that they were interested; however, they never later called. Perhaps, they lost my phone number. A representative from one of the other companies even told me something on the order of "Yeah, we know that the Garber and Brevick models are totally wrong, but we do not care; just go away—you are bothering us!"

I have news for you guys: **the new knowledge is here to stay and if you want to make the die casting industry prosper, you should adopt the new technologies.** You should make the die casting industry prosper so that you will prosper as well; please do not look at the short terms as important.

The next issue of the Die Casting Engineer (May/June 1999 issue) was dedicated to machine products. Whether this was coincidental, you be the judge.

I submitted a proposal to NADCA (November 5, 1996) about Garber/Brevick work (to which

I never received a reply). Two things have happened since: I made the proposal (in the proposal I demonstrate that Brevick's work from Ohio is wrong) 1) publishing of the article by Bill Walkington in NADCA magazine about the "wonderful research" in Ohio State University and the software to come. 2) a "scientific" article by EKK. During that time EKK also advertised how good their software was for shot sleeve calculations. Have you seen any EKK advertisements on the great success of shot sleeve calculations lately?

Here is another interesting coincidence, After 1996, I sent a proposal to NADCA, the cover page of DCE showing the beta version of software for calculating the critical slow plunger velocity. Yet, no software has ever been published. Why? Is it accidental that the author of the article in the same issue was Bill Walkington.

And after all this commotion I was surprised to learn in the (May/June 1999) issue of DCE magazine that one of the Brevick group had received a prize (see picture below if I get NADCA permission). I am sure that Brevick's group has made so much progress in the last year that this is why the award was given. I just want to learn what these accomplishments are.

put the picture of Brevick, Udvardy and price guy

For a long time NADCA described the class on the pQ^2 diagram as a "A close mathematical description." After I sent the paper and told them about how the pQ^2 diagram is erroneous, they change the description. Well it is good, yet they have to say that in the past material was wrong and now they are teaching something else. or are they?

I have submitted five (5) papers to the conference (20th in Cleveland) and four (4) have been rejected on the grounds well, you can read the letter yourself:

Here is the letter from Mr. Robb.

17 Feb 1999

The International Technical Council (ITC) met on January 20th to review all submitted abstracts. It was at that time that they downselected the abstracts to form the core of each of the 12 sessions. The Call for Papers for the 1999 Congress and Exposition produced 140 possible abstracts from which to choose from, of this number approximately 90 abstracts were selected to be reviewed as final papers. I did receive all 5 abstracts and distribute them to the appropriate Congress Chairmen. The one abstract listed in your acceptance letter is in fact the one for which we would like to review the final paper. The Congress Chairmen will be reviewing the final papers and we will be corresponding with all authors as to any changes revisions which are felt to be appropriate.

The Congress Chairmen are industry experts and it is their sole discretion as to which papers are solicited based on abstract topic and fit to a particular session.

It is unfortunate that we cannot accept all abstracts or papers which are submitted.

Entering an abstract does not constitute an automatic acceptance of the abstract/or final paper.

Thank you for your inquiry, and we look forward to reviewing your final paper.

Regards,

Dennis J. Robb

NADCA

I must have submitted the **worst kind** of papers otherwise. How can you explain that only 20% of my papers (1 out of 5) accepted. Note that the other researchers' ratio of acceptance on their papers is 65%, which means that other papers are three times better than mine.

Please find here the abstracts and decide if you'd like to hear such topics or not. Guess which the topic NADCA chose, in what session and on what day (third day).

A Nobel Tangential Runner Design

The tangential gate element is commonly used in runner designs. A novel approach to this runner design has been developed to achieve better control over the needed performance. The new approach is based on scientific principles in which the interrelationship between the metal properties and the geometrical parameters is described.

Vacuum Tank Design Requirements

Gas/air porosity constitutes a large part of the total porosity. To reduce the porosity due to the gas/air entrainment, vacuum can be applied to remove the residual air in the die. In some cases the application of vacuum results in a high quality casting while in other cases the results are not satisfactory. One of the keys to the success is the design of the vacuum system, especially the vacuum tank. The present study deals with what are the design requirements on the vacuum system. Design criteria are presented to achieve an effective vacuum system.

How Cutting Edge technologies can improve your Process Design approach

A proper design of the die casting process can reduce the lead time significantly. In this paper a discussion on how to achieve a better casting and a shorter lead time utilizing these cutting edge technologies is presented. A particular emphasis is given on the use of the simplified calculations approach.

On the effect of runner design on the reduction of air entrainment: Two Chamber Analysis

Reduction of air entrapment reduces the product rejection rate and always is a major concern by die casting engineers. The effects of runner design on the air entrapment have been disregarded in the past. In present study, effects of the runner design characteristics are studied. Guidelines are presented on how to improve the runner design so that less air/gas are entrapped.

Experimental study of flow into die cavity: Geometry and Pressure effects

The flow pattern in the mold during the initial part of the injection is one of the parameters which determines the success of the casting. This issue has been studied experimentally. Several surprising conclusions can be drawn from the experiments. These results and conclusions are presented and can be used by the design engineers in their daily practice to achieve better casting.

Afterward

At the 1997 NADCA conference I had a long conversation with Mr. Warner Baxter. He told me that I had ruffled a lot of feathers in NADCA. He suggested that if I wanted to get real results, I should be politically active. He told me how bad the situation had been in the past and how much NADCA had improved. But here is something I cannot understand: isn't there anyone who cares about the die casting industry and who wants it to flourish? If you do care, please join me. I actually have found some individuals who do care and are supporting my efforts to increase scientific knowledge in die casting. Presently, however, they are a minority. I hope that as Linux is liberating the world from Microsoft, so too we can liberate and bring prosperity to the die casting industry.

After better than a year since my first (and unsent) letter to Steve Udvardy, I feel that there are things that I would like to add to the above letter. After my correspondence with Paul Bralower, I had to continue to press them to publish the article about the pQ^2 . This process is also described in the preceding section. You, the reader, must be the judge of what is really happening. Additionally, open questions/discussion topics to the whole die casting community are added.

What happened to the Brevick's research? Is there still no report? And does this type of research continue to be funded?

Can anyone explain to me how NADCA operates?

Is NADCA, the organization, more important than the die casting industry?

APPENDIX C

Density change effects

In this appendix we will derive the boundary condition for phase change with a significant density change. Traditionally in die casting the density change is assumed to be insignificant in die casting. The author is not aware of any model in die casting that take this phenomenon into account. In materials like steel and water the density change isn't large enough or it does not play furthermore important role. While in die casting the density change play a significant role because a large difference in values for example aluminum is over 10%. Furthermore, the creation of shrinkage porosity is a direct consequence of the density change.

A constant control volume¹ is constructed as shown in figure C.1. Solid phase is on the right side and liquid phase is on the left side. After a small time increment the moved into the the dashed line at a distance dx . The energy conservation of the control volume reads

$$\frac{d}{dt} \int_V \rho h dV = - \int_A \rho h v_i dA + \int_A k \frac{\partial T}{\partial n} dA \quad (C.1)$$

Analogy the mass conservation for the control volume is

$$\frac{d}{dt} \int_V \rho dV = - \int_A \rho v_i dA \quad (C.2)$$

The equations (C.1) and (C.2) do not have any restrictions of the liquid movement which has to be solved separately. Multiply equation (C.1) by a constant h_l results in

$$\frac{d}{dt} \int_V \rho h_l dV = - \int_A \rho h_l v_i dA \quad (C.3)$$

¹A discussion on the mathematical aspects are left out. If explanation on this point will be asked by readers I will added it.

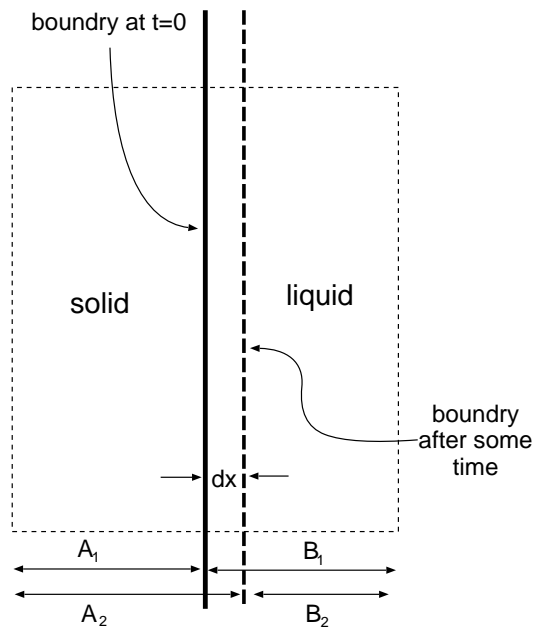

Figure C.1: The control volume of the phase change

Subtraction equation (C.3) from equation (C.1) yields

$$\frac{d}{dt} \int_V \rho(h - h_l) dV = - \int_A \rho(h - h_l) v_i dA + \int_A k \frac{\partial T}{\partial n} dA \quad (C.4)$$

The first term on the right hand side composed from two contributions: one) from the liquid side and two) from solid side. At the solid side the contribution is vanished because $\rho(h - h_l)v_i$ is zero due to v_i is identically zero (no movement of the solid, it is a good assumption). In the liquid phase the term $h - h_l$ is zero (why?) thus the whole term is vanished we can write the identity

put explanation or question

$$\int_A \rho(h - h_l) v_i dA \equiv 0 \quad (C.5)$$

where v_i is the velocity at the interface.

maybe the derivations are too long, shorten them?

The first term of equation (C.4) can be expressed in the term of the c.v.² as

$$\begin{aligned} \frac{d}{dt} \int_V \rho(h - h_l) dV &= \frac{\overbrace{\rho_s A_2 (h_s - h_l) - \rho_s A_1 (h_s - h_l)}^{\text{solid}} + \overbrace{(\dots (h_l - h_l))}^{\text{liquid}=0}}{dt} \\ &= (\rho_s (h_s - h_l)) \frac{dx}{dt} = \rho_s (h_s - h_l) v_n \end{aligned} \quad (C.6)$$

² please note some dimensions will canceled each other out and not enter into equations

liquid side contribution is zero since $h - h_l \equiv 0$ and the solid contribution appears only in transitional layer due to transformation liquid to solid. The second term on right hand side of equation (C.4) is simply

$$\int_A k \frac{\partial T}{\partial n} dA = k_s \frac{\partial T}{\partial n} - k_l \frac{\partial T}{\partial n} \quad (C.7)$$

Thus, equation (C.4) is transformed into

$$\rho_s (h_s - h_l) v_n = k_s \frac{\partial T}{\partial n} - k_l \frac{\partial T}{\partial n} \quad (C.8)$$

It is noteworthy that the front propagation is about 10% previously was calculated. Equation (C.7) holds as long as the transition into solid is abrupt (sharp transition).

Meta For the case of where the transition to solid occurs over temperature range we have create three zones. Mathematically, it is convenient to describe the the mushy zone boundaries by two boundary conditions.

End

Meta The creation of voids is results of density changes which change the heat transfer mechanism from conduction to radiation. The location of the void depends on the crystallization and surface tension effect, etc. The possibility of the "liquid channels" and the flow of semi-solid and even solid compensate for this void.

End

Klein's paper

Meta Yet, one has to take into consideration the pressure effect The liquidation temperature and the latent heat are affected somewhat by the pressure. At pressure between the atmospheric to typical intensification pressure the temperature and latent heat are effected very mildly. However, for pressure near vacuum the latent heat and the temperature are effected more noticeably.³

End

The velocity of the liquid metal due to the phase change can be related to the front propagation utilizing the equation (C.2). The left hand side can be shown to be $(\rho_s - \rho_l)v_n$. The right hand side is reduced into only liquid flow and easily can be shown to be $\rho_l v_l$.

$$\begin{aligned} (\rho_s - \rho_l) v_n + \rho_l v_l &= 0 \\ (\hat{\rho} - 1) &= \frac{v_l}{v_n} \end{aligned} \quad (C.9)$$

where $\hat{\rho}$ is the density ratio, ρ_s/ρ_l .

³I have used Clapyron's equation to estimate the change in temperature to be over 10 degrees (actually about 40⁰[C]). However, I am not sure of this calculations and I had not enough time to check it in the literature. If you have any knowledge and want to save me a search in the library, please drop me a line.

APPENDIX D

Fanno Flow

The flow of air through the venting system is a flow of compressible substance. There are three ideal models that can potentially describe the situation.

- The flow of the air/gas is adiabatic i.e. no heat transfer is negligible and can be ignored. This is the case where process is very fast and heat transfer mechanisms are considerably slower (see more discussion about dimensionless number in Chapter ??). This kind of is known as Fanno flow.
- another possibility is there is an heat transfer and the simplest possible case is when this heat transfer is a constant. The heat transfer is significant in case where there is chemical reactions sometime referred to as combustion. This flow is named on Lord Rayleigh.
- A case between the two previous case is the isothermal case. The flow is has heat transfer but is low enough to keep the temperature constant. This is the case when a gas flows for a long distance (in order of kilometers). In such cases, the gas temperature is equal to surrounding temperature. If the surrounding are in uniform temperature (that is simplest case which we like) is called isothermal case. Mathematically, it is the simplest case¹.

In die casting, the air/gas flows from the cavity to surrounding in very rapid manner. This situation is very close the first model we described before. Hence, we can assume that for many of the cases the flow is reasonably adiabatic². Therefore, we introduce the Fanno flow and again in a simplified form.

¹I prefer to teach this material first in my classes. The real simplest case is the isentropic flow for which the pressure is constant in constant conduct area.

²in poor design the metal drops flow with the air and solidified. The heat is released to the air and the air temperature is increased. This analysis is much more complicated and dependent on the flow. Presently, there is no model to account for it and to find the error in the assumption of adiabatic flow.

D.1 Introduction

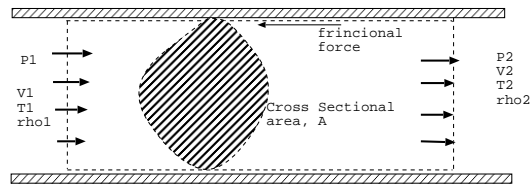

Figure D.1: Control volume of the gas flow in constant cross section

add a figure with an element
volume very thin

Consider a gas flows through a conduit with a friction (see Figure D.1. The mass conservation for the control volume is

$$\rho_1 V_1 = \rho_2 V_2 \quad (\text{D.1})$$

The energy conservation (under the consriction of ideabctic flow) reads

$$T_{01} = T_1 + \frac{V_1^2}{2C_{p0}} = T_2 + \frac{V_2^2}{2C_{p0}} \quad (\text{D.2})$$

The force acting on the gas is the friction and the momentum conservation reads

$$-AdP - \tau_w dA = \dot{m}dV \quad (\text{D.3})$$

For simplify the presentation/footnotenot nesslerly for the presentation can be close to circular we assume the conduit to be a circular therefore,

$$-dP + \tau_w \frac{dA_w}{A} = \frac{\dot{m}}{A} dV \quad (\text{D.4})$$

Note that $\frac{dA_w}{A}$ is equal to $4D$. Utilizing the defination of the friccion factor $\frac{f \equiv \tau}{1/2\rho V^2}$ and we obtain the following

$$-dP - \frac{4}{D} f dx (1/2\rho V^2) = \frac{\dot{m}}{A} dV \quad (\text{D.5})$$

Utilizing the definition of the sound speed one can obtain the following

$$-\frac{dP}{P} - \frac{4f dx}{D} \left(\frac{kM^2}{2} \right) = kM^2 \frac{dV}{V} \quad (\text{D.6})$$

Converting the exprestion for (dP/P) and for $*dV/V$ in term of the Mach nubmer yeilds

$$\frac{4f dx}{D} = \frac{(1 - M^2) dM^2}{kM^4(1 + \frac{k-1}{2}M^2)} \quad (\text{D.7})$$

Section D.1. Introdccion

Integrating last equation yeild

$$\frac{4}{D} \int_x^{x_{max}} f dx = \frac{1}{k} \frac{1 - M^2}{M^2} + \frac{k+1}{2k} \ln \frac{\frac{k+1}{2} M^2}{1 + \frac{k-1}{2} M^2} \quad (D.8)$$

The results of this equation are plotted in Figure ??

Figure D.2: Fanno flow as a function of $\frac{4fL}{D}$

APPENDIX E

Reference

BIBLIOGRAPHY

- ASM1987. *Metals Handbook* , volume 13. ASM, Metals Park, Ohio.
- Backer, G. and Sant, F.1997. Using Finite Element Simulation for the Development of Shot Sleeve Velocity Profiles . In *NADCA 19th Congress and exposition*, Minneapolis, Minnesota. paper T97-014.
- Bar-Meir, G.1995a. *On gas/air porosity in pressure die casting* . PhD thesis, University of Minnesota.
- Bar-Meir, G.1995b. Analysis of mass transfer processes in the pore free technique. *Journal of Engineering Materials and Technology* , 117:215 – 219.
- Bar-Meir, G., Eckert, E., and Goldstein, R. J.1996. Pressure die casting: A model of vacuum pumping. *Journal of Engineering for Industry* , 118:001 – 007.
- Bar-Meir, G., Eckert, E. R. G., and Goldstein, R. J.1997. Air venting in pressure die casting. *Journal of Fluids Engineering* , 119:473 – 476.
- Bar-Meir, G. and Winkler, L.1994. Accurate pQ^2 Calculations . *Die Casting Engineer* , No. 6:26 – 30. November – December.
- Bélanger, J. M.1828. Essai sur la solution numerique de quelques problemes, mouvement permanent des eaux courantes. Paris, France.
- Bochvar, A., A., Notkin, E., M., Spektorova, S. I., and Sadchikova, N.1946. The Study of Casting Systems by Means of Models. *Izvest. Akad. Nauk U.S.S.R. (Bulletin of the Academy of Sciences of U.S.S.R)* , pages 875–882.
- Branch, H. L.1958. *Hydraulic Design of Stilling Basins and Bucket Energy Dissipators* . U.S. Bureau of Reclamation, Engineering Monograph 25, Denver, Colorado.
- Brevick, J. R., Armentrout, D. J., and Chu, Y.-L.1994. Minimization of entrained gas porosity in aluminum horizontal cold chamber die castings . *Transactions of NAMRI/SME* , 12:41–46.

- Cocks, D. L. 1986. *DCRF Recommended Procedures: Metal Flow Predictor System*. American Die Casting Institute, Inc., Des Plaines, Illinois.
- Cocks, D. L. and Wall, A. J. 1983. Technology transfer in the united kingdom: Progress and prospects. In *Transactions 12th International SDCE*, Minneapolis, Minnesota. paper G-T83-074.
- Davey, K. and Bounds, S. 1997. Modeling the pressure die casting process using boundary and finite element methods. *Journal of material Processing Technology*, 63:696–700.
- Davis, A. J. 1975. Effects of the relationship between molten metal flow in feed systems and hydraulic fluid flow in die casting machines. In *Transactions 8th International SDCE*, St. Louis. paper G-T75-124.
- Draper, A. B. 1967. Effect of vent and gate areas on the porosity of die casting. *Transactions of American Foundrymen's Society*, 75:727–734.
- Eckert, E. 1989. Similarity analysis applied to the Die Casting Process. *Journal of Engineering Materials and Technology*, 111:393–398. No. 4 Oct.
- El-Mehalawi, M., Liu, J., and Miller, R. A. 1997. A cost estimating model for die cast products. In *NADCA 19th Congress and exposition*, Minneapolis, Minnesota. paper T97-044.
- Fairbanks 1959. *Hydraulic Handbook*. Mores and Co., Kansas city, Kansas.
- Fondse, H., Jeijdens, H., and Ooms, G. 1983. On the influence of the exit conditions on the entrainment rate in the development region of a free, round, turbulent jet. *Applied Scientific Research*, pages 355–375.
- Garber, L. W. 1982. Theoretical analysis and experimental observation of air entrapment during cold chamber filling. *Die Casting Engineer*, 26 No. 3:33.
- Hansen, Arthur, G. 1967. *Fluid Mechanics*. John Wiley and Sons, Inc., New York, New York.
- Henderson, F. M. 1966. *Open Channel Flow*. Macmillan Publishing Co., New York, New York.
- Horacio, A. G. and Miller, R. A. 1997. Die casting die deflections: computer simulation of causes and effects. In *NADCA 19th Congress and exposition*, Minneapolis, Minnesota. paper T97-023.
- Hu, H. and Argyropoulos, S. A. 1996. Mathematical modeling of solidification and melting: a review. *Modeling Simulation Mater. Sci. Eng.*, 4:371–396.
- Hu, J., Ramalingam, S., Meyerson, G., Eckert, E., and Goldstein, R. J. 1992. Experiment and computer modeling of the flows in pressure die casting casings. In *ASME/CIE Design*, San Francisco, California.
- Karni, Y. 1991. *Selection of process variables for die casting*. PhD thesis, Ohio State University.
- Kim, C. M. and Sant, F. J. 1995. An application of 3–D solidification analysis to large complex castings. In *2nd Pacific rim international conference on modeling of casting and solidification*, Singapore.

BIBLIOGRAPHY

- Lindsey, D. and Wallace, J. F.1972. Effect of vent size and design, lubrication practice, metal degassing, die texturing and filling of shot sleeve on die casting soundness. In *Transactions 7th SDCE International Die Casting Congress*, Chicago. paper 10372.
- Madsen, P. and Svendsen1983. Turbulent bores and hydraulic jumps. *Journal of Fluid Mechanics*, 129:1–25.
- Maier, R. D.1974. *Influence of liquid metal jet character on heat transfer during die casting*. PhD thesis, Case Western Reserve University. Engineering, metallurgy.
- Minaie, B., Stelson, K., and Voller, V. R.1991. Analysis and flow patterns and solidification phenomena in die casting processes . *J. Eng. Mech. Technology. ASME* , 113:296–302.
- Nguyen, T. and Carrig, J.1986. Water Analogue Studies of Gravity Tilt Casting Copper Alloy components. *AFS Trans* , pages 519–528.
- Osborne, M. A., Mobley, C. E., Miller, R. A., and Kallien, L. H.1993. Modeling of die casting processes using magmasoft. In *NADCA 17th Congress and exposition*, Cleveland, Ohio. paper T93-032.
- Pao, R. H. F.1961. *Fluid Mechanics*. John Wiley and Sons, Inc., New York, New York.
- Rajaratnam, N.1965. The hydraulic jump as a wall jet. *Journal of Hydraulic Div. ASCE*, pages 107–131. 91 (HY5).
- Sachs, B.1952. *An analytical study of the die casting process*. PhD thesis, Columbia University.
- Shapiro, A. H.1953. *The Dynamics and thermodynamics of Compressible Fluid Flow* , volume I. John Wiley and Sons, New York.
- Stuhrke, W. F. and Wallace, J. F.1966. Gating of die castings. *Transactions of American Foundrymen's Society* , 73:569–597.
- Swaminathan, C. R. and Voller, V. R.1993. On the Enthalpy Method. *Int J. Num. Meth. Heat Fluid Flow* , 3:233–244.
- Thome, M. and Brevick, J. R.1995. Optimal slow shot velocity profiles for cold chamber die casting. In *NADCA Congress and exposition*, Indianapolis, Indiana. paper T95-024.
- Veinik, A. I.1962. *Theory of special casting method* . ASME, New York.
- Veinik, A. I.1966. Thermodynamic factors in metal injection: effect of friction on gas content and quality. In *Transactions 4th SDCE International Die Casting Exposition & Congress*, Cleveland, Ohio. paper 103.
- Viswanathan, S., Brinkman, C., Porter, W. D., and Purgert, R. M.1997. Production of A357 motor mount bracket by the metal compression forming process. In *NADCA 19th Congress and exposition*, Minneapolis, Minnesota. paper T97-121.
- Wyganski, I. and Champan, F. H.1973. The origin of puffs and slugs and the flow in a turbulent slug. *J. Fluid Mechanics* , pages 281–335.