

ASSEMBLING
AND USING
YOUR

Heathkit

HIGH FIDELITY
AMPLIFIER
MODEL W-5M

595-103

Copyright 1955
Heath Company,
Benton Harbor, Michigan

HEATH COMPANY

BENTON HARBOR,
MICHIGAN

PRICE \$1.00

THE WORLD'S *Finest* TEST EQUIPMENT IN KIT FORM

STANDARD COLOR CODE — RESISTORS AND CAPACITORS

AXIAL LEAD RESISTOR	INSULATED UNINSULATED	FIRST RING BODY COLOR	SECOND RING END COLOR	THIRD RING DOT COLOR	DISC CERAMIC RMA CODE
	Color	First Figure	Second Figure	Multiplier	
	BLACK	0	0	None	
	BROWN	1	1	0	
	RED	2	2	00	
	ORANGE	3	3	,000	
	YELLOW	4	4	0,000	
	GREEN	5	5	00,000	
	BLUE	6	6	000,000	
	VIOLET	7	7	0,000,000	
	GRAY	8	8	00,000,000	
	WHITE	9	9	000,000,000	

RADIAL LEAD DOT RESISTOR	5-DOT RADIAL LEAD CERAMIC CAPACITOR	EXTENDED RANGE TC CERAMIC HICAP
RADIAL LEAD (BAND) RESISTOR	BY-PASS COUPLING CERAMIC CAPACITOR	AXIAL LEAD CERAMIC CAPACITOR

The standard color code provides all necessary information required to properly identify color coded resistors and capacitors. Refer to the color code for numerical values and the zeroes or multipliers assigned to the colors used. A fourth color band on resistors determines tolerance rating as follows: Gold = 5%, silver = 10%. Absence of the fourth band indicates a 20% tolerance rating.

The physical size of carbon resistors is determined by their wattage rating. Carbon resistors most commonly used in Heathkits are 1/2 watt. Higher wattage rated resistors when specified are progressively larger in physical size. Small wire wound resistors 1/2 watt, 1 or 2 watt may be color coded but the first band will be double width.

MOLDED MICA TYPE CAPACITORS

CURRENT STANDARD CODE	RMA 3-DOT (OBSOLETE) RATED 500 W.V.D.C. ± 20% TOL.	BUTTON SILVER MICA CAPACITOR
RMA (5-DOT OBSOLETE CODE)	RMA 6-DOT (OBSOLETE)	RMA 4-DOT (OBSOLETE)

MOLDED PAPER TYPE CAPACITORS

TUBULAR CAPACITOR	MOLDED FLAT CAPACITOR	JAN. CODE CAPACITOR
<p>A 2 digit voltage rating indicates more than 900 V. Add 2 zeros to end of 2 digit number.</p>	<p>Normally stamped for value</p>	

The tolerance rating of capacitors is determined by the color code. For example: red = 2%, green = 5%, etc. The voltage rating of capacitors is obtained by multiplying the color value by 100. For example: orange = 3 × 100 or 300 volts. Blue = 6 × 100 or 600 volts.

In the design of Heathkits, the temperature coefficient of ceramic or mica capacitors is not generally a critical factor and therefore Heathkit manuals avoid reference to temperature coefficient specifications.

THE HEATHKIT W-5M HIGH FIDELITY AMPLIFIER

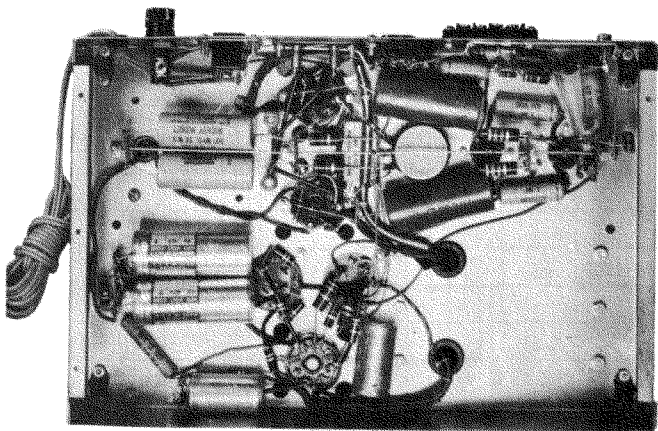

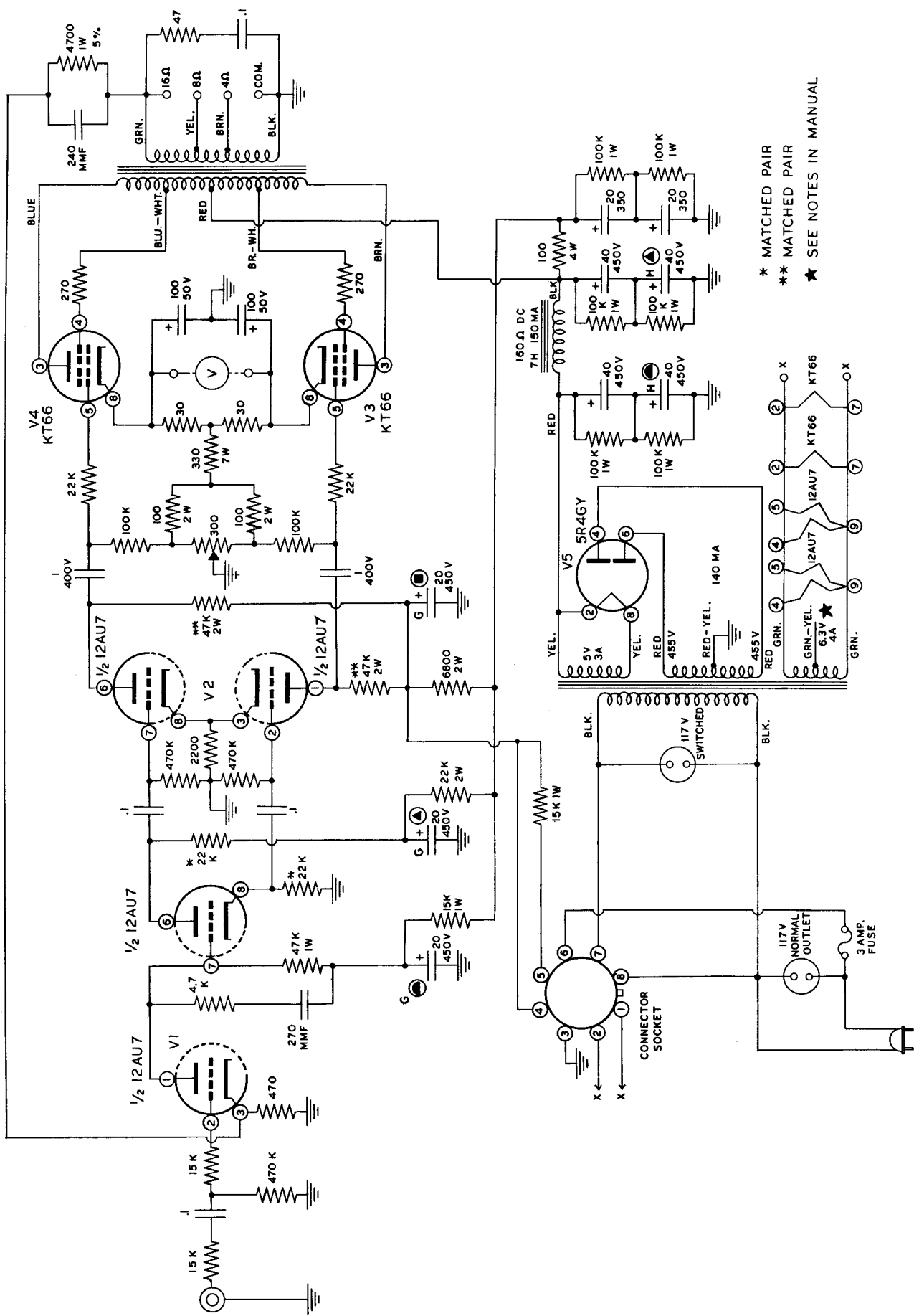

THE HEATHKIT W-5M HIGH FIDELITY AMPLIFIER

SPECIFICATIONS

NOTE: There is, as yet, no general agreement for specifying amplifier performance. A cursory review of specifications may easily give a highly distorted picture of the characteristics of the amplifier. In general, it may be assumed that the most important specifications are those which are not shown.

At first glance, the specifications presented here may seem quite complex and possibly, confusing. We feel that it is necessary to provide you with complete and factual information about the Heathkit W-5M Amplifier. We urge your direct comparison of these figures against those for competitive amplifiers. It is our intention to furnish you with enough information to point up the fact that, in general, only the most optimistic technical information reaches the prospective buyer of high fidelity amplifiers.

The specifications below have been taken with the most modern and accurate test equipment available today. They are actual measurements taken on a typical amplifier, under carefully controlled conditions; not to present the most favorable advertising information, but in strict accordance with all generally accepted standard conditions. These conditions are listed at the end of this specification.

Minor variations from these specifications may be encountered in kit-assembled amplifiers. Such factors as exact lead placement, component variations and tube characteristics are possible sources of deviations. In a highly stabilized amplifier, such as the W-5M, these variables may be disregarded from a performance point of view.

POWER OUTPUT:

- Rated Power..... 25 watts
- Maximum Average Power.....32.5 watts
- Peak Power.....47.2 watts
- Power Output Related to Frequency..... See Figure 1.

Please note that on the 15, 20 and 25 watt curves, portions of the characteristic have been broken. Power measurements cannot be considered valid in this region because they were made with meters calibrated to RMS values. Waveform distortion in the broken areas was sufficient to invalidate such readings.

On the power curves, asterisks have been used to designate overload points at both low and high frequency limits.

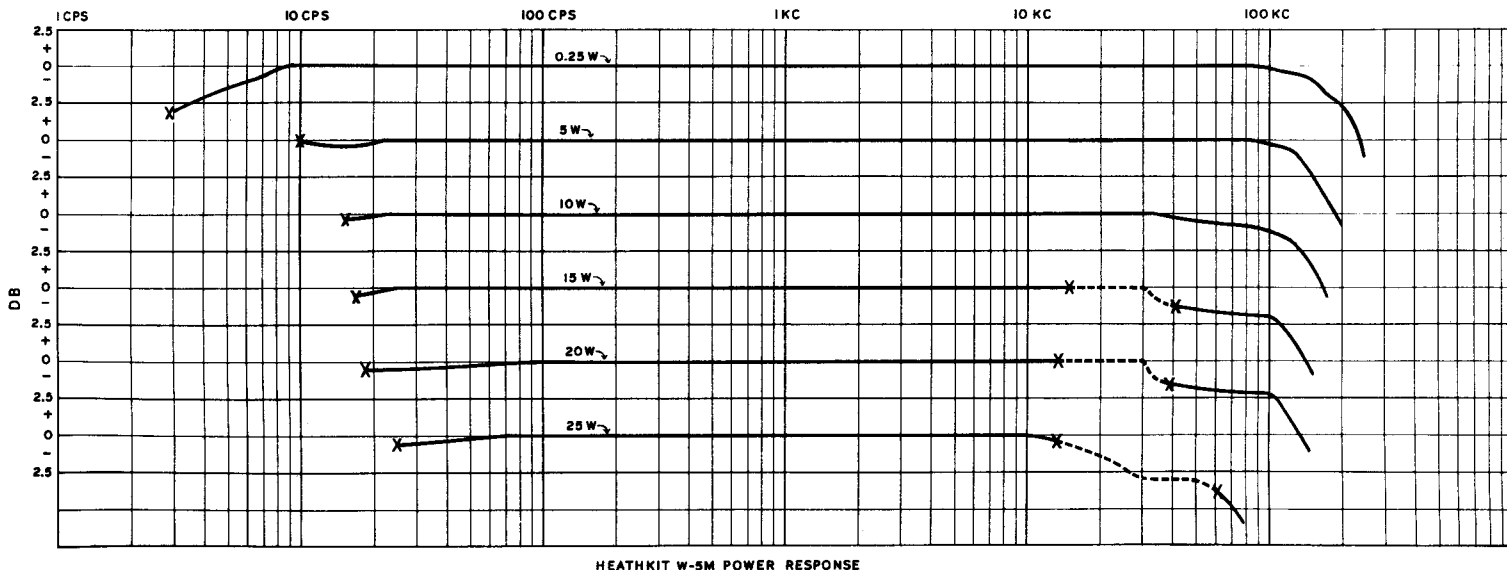

Figure 1

One of the outstanding features of the W-5M is the remarkable low frequency power response. Observe that the 0.25 watt curve extends smoothly to 3 cps and is only down 3 db at this point. Also, note that it is possible to obtain 20 watts of power at 20 cps without overloading. In conventional amplifiers, low frequency response at low levels has been sadly lacking. At high levels these amplifiers tend to go into overload and block on heavy bass passages. Because of the unique output transformer design featured in the W-5M, low frequency power response is greatly improved. Special attention has been given to the problem of overload recovery. (See "Overload Recovery" on Page 7.)

FREQUENCY RESPONSE:

See Figure 2 below. This curve was taken at 1 watt reference output and may be considered as the voltage response of the amplifier

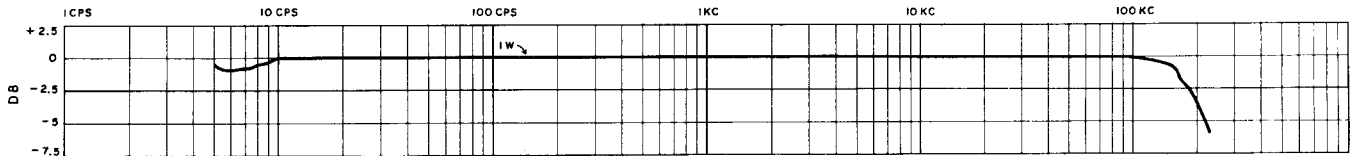

Figure 2 HEATHKIT W-5M FREQUENCY RESPONSE (1 WATT OUTPUT)

An outstanding characteristic of the W-5M amplifier is the complete absence of the rising response at the low and high limits of the pass band which has been considered a necessary evil up to the present time. Although outside the audible range, such humps add to the instability of the amplifier and tend to create distortion in the audio range. This happens when low frequency transients, such as turntable rumble, line voltage surges or tuning thumps, drive the amplifier into low-frequency overload. In the W-5M, these transients cannot create any audible distortion and no hangover or "breathing" conditions are evident.

The curve in Figure 2, taken at 1 watt output and the 5 watt curve in Figure 1, represent average room listening levels. In this amplifier, a minimum of 500% reserve power is available to accomodate heavy bass passages and to make up for the relative inefficiency of less expensive speaker systems.

HARMONIC DISTORTION:

Figure 3 below gives five curves which relate the total harmonic distortion to power output throughout the frequency range. From these curves it becomes evident that specifying total harmonic distortion at any power level without designating the test frequency can be very misleading.

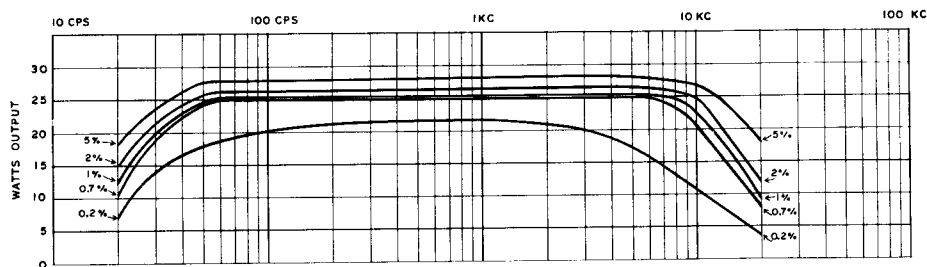

Figure 3 HEATHKIT W-5M TOTAL HARMONIC DISTORTION (DETERMINANT: DISTORTION)

Competent authorities seem to agree that a total of 2% harmonic distortion is tolerable for musical reproduction through wide-range audio equipment. Harmonic distortion below 0.7% is completely imperceptible, even to highly trained critical observers. Curves showing the output obtainable at these distortion levels throughout the frequency range have been included above.

Figure 4 indicates the distortion versus frequency curves for several power levels.

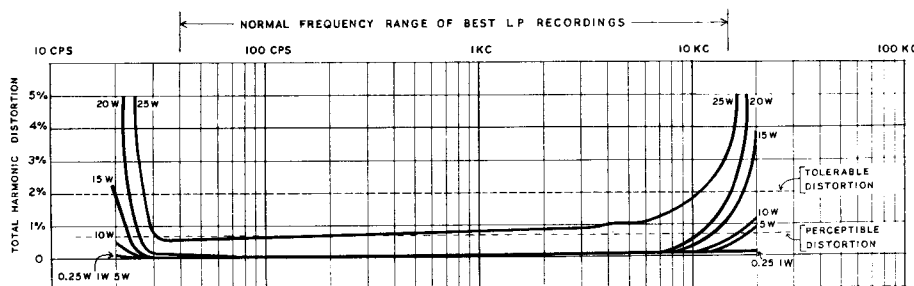

Figure 4 HEATHKIT W-5M TOTAL HARMONIC DISTORTION (DETERMINANT: POWER OUTPUT)

INTERMODULATION DISTORTION:

Intermodulation distortion curves for three separate test conditions are plotted in Figure 5. Please observe that, again, the generally accepted limits for "extremely high fidelity" amplifiers and "high fidelity amplifiers" have been added to the graph. The W-5M amplifier will supply over 20 watts of power under any one of the three test conditions before its intermodulation distortion exceeds the "extremely high fidelity" requirements.

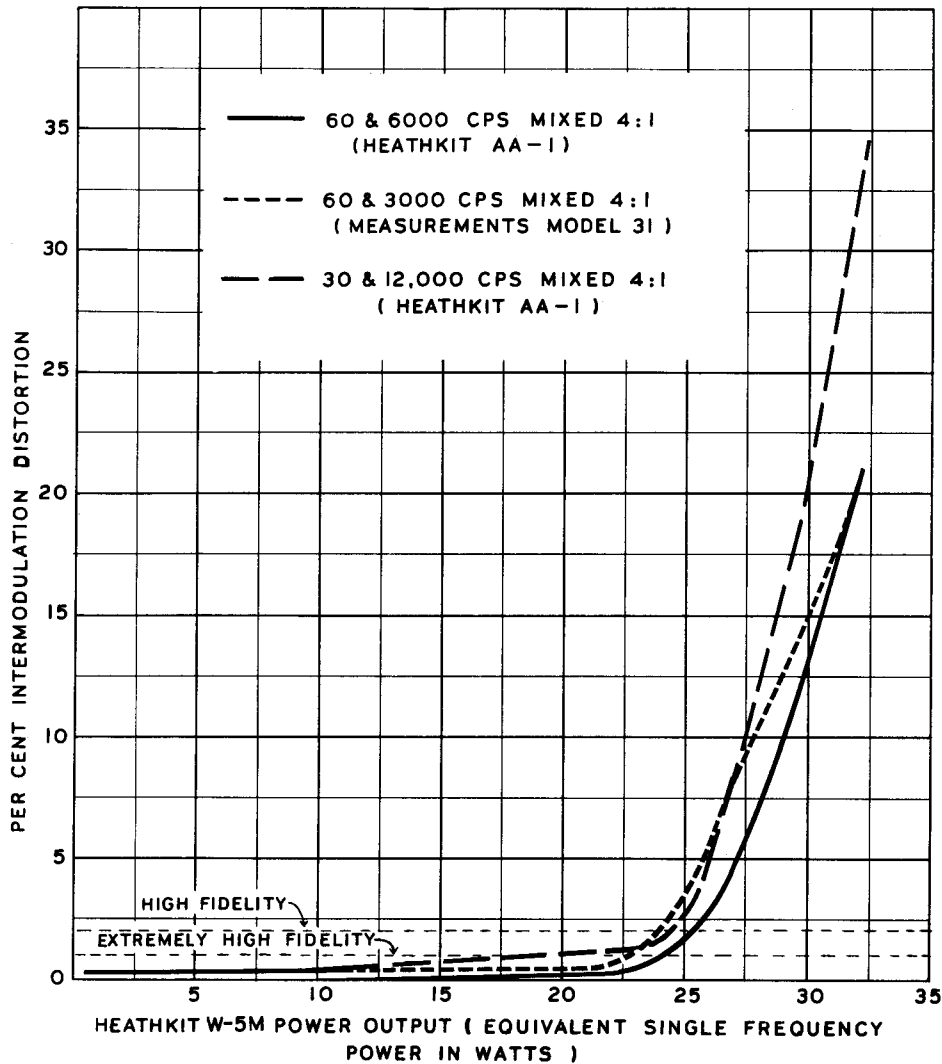

Figure 5

PHASE SHIFT:

See Figure 6 below, which is self-explanatory.

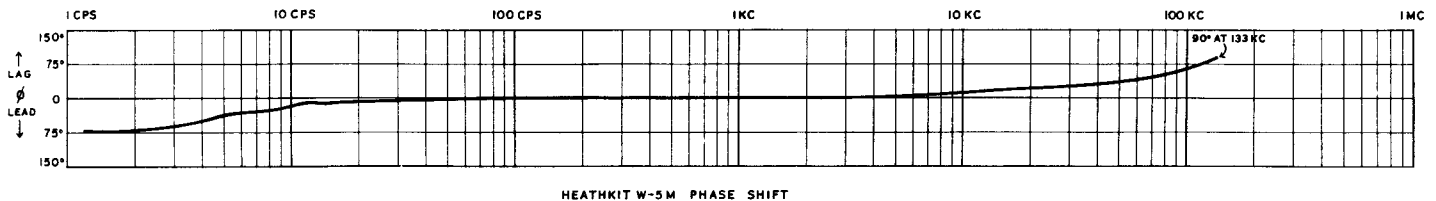

Figure 6

A phase shift of 75° occurs at 1.2 cps. It was impossible to locate the 90° leading point, since it occurs below the pass-band of the amplifier. Note also that the phase shift occurs gradually throughout the frequency range, rather than quite abruptly as is generally true of amplifiers with heavy feedback. This contributes further to the stability of the amplifier.

SENSITIVITY:

Figure 7 below indicates voltage input required to drive the amplifier through its entire output power range.

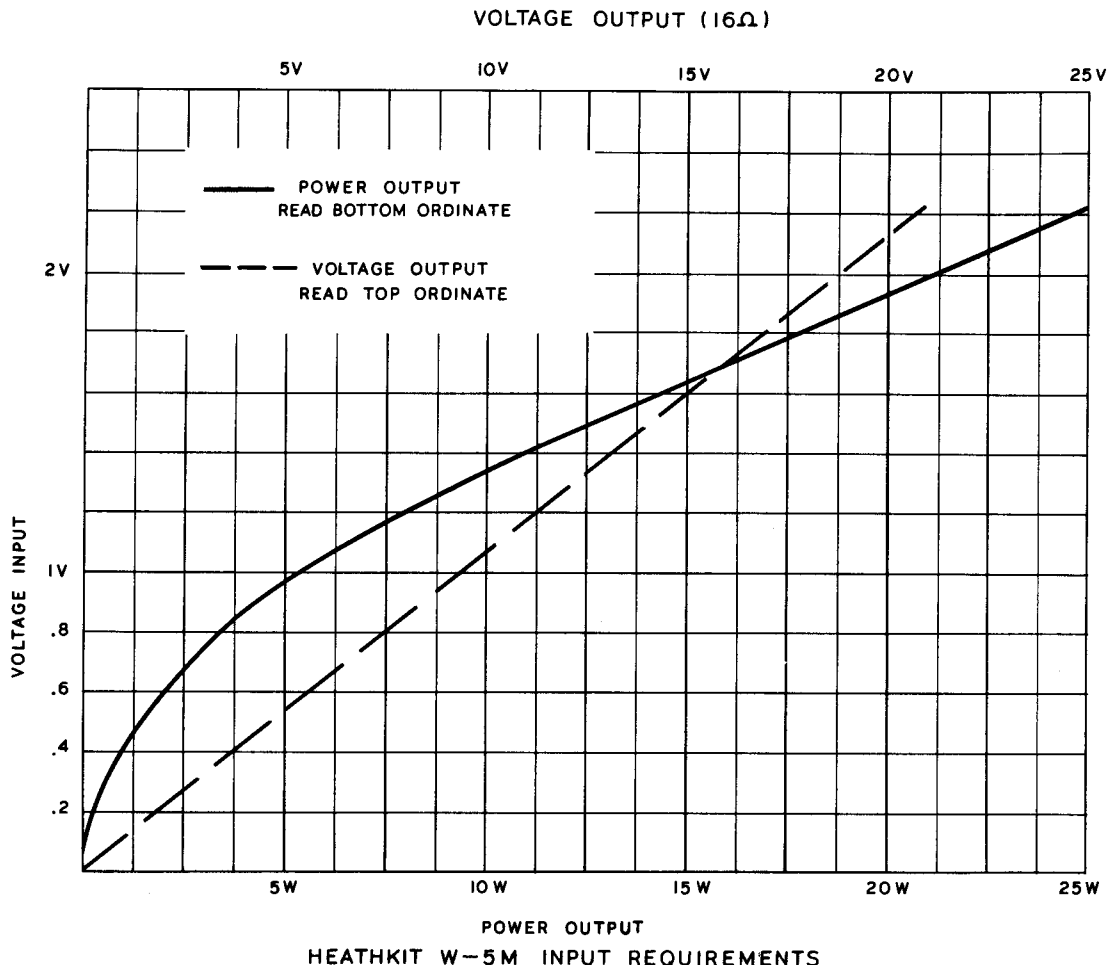

Figure 7

The broken line has been plotted to show the linearity of the input-output voltage characteristic of the amplifier.

HUM AND NOISE:..... 80.2 db below 250 milliwatts, unweighted. (General average listening level.)
 84.2 db below 5 watts, unweighted. (Loud average listening level.)
 99 db below 25 watts, unweighted.

A noise level of 60 db below 100% modulation for AM or FM broadcast stations is recognized as acceptable by the Federal Communications Commission. Most stations exceed this figure to some extent. Modern LP recordings seldom exceed 40 db below average program level. Broadcast quality tape recorders attain a noise level 60 db below full output. The extremely low noise level of the W-5M exceeds these requirements comfortably, even at very low output levels where noise is most noticeable.

OUTPUT TUBE BALANCE:..... Unique "Bass-Bal" circuit, requires only simple volt-meter for indication of exact balance.

FEEDBACK FACTOR:..... 18.1 db of feedback is applied around the entire amplifier and output transformer.

OUTPUT IMPEDANCES:..... 4, 8 or 16 ohms, unbalanced.

DAMPING FACTOR:..... 40

TRANSIENT RESPONSE:..... Square-wave response characteristics of the W-5M are shown in the oscillograms below:

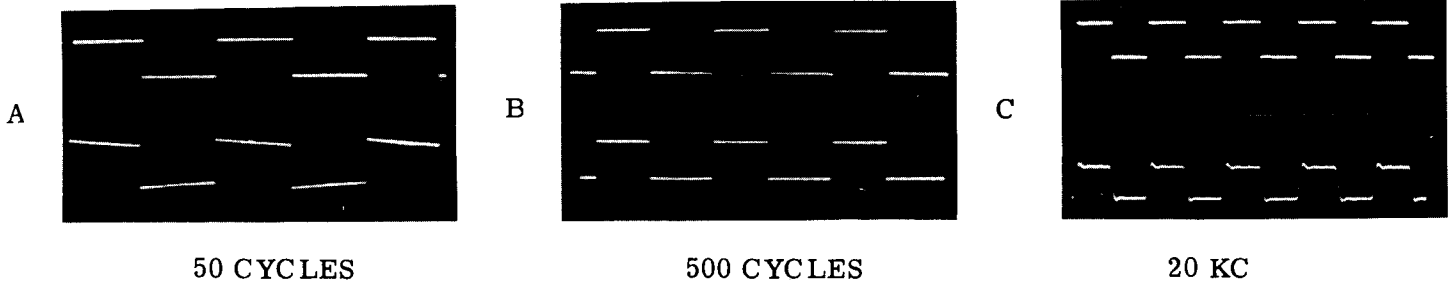

NOTE: In all oscillograms used in these specifications, the upper trace represents the signal applied to the input of the amplifier. The lower trace displays the output signal across a 16 Ω load.

In A above, observe that the output wave shape, although "tilted" slightly, shows no evidence of rounding, overshoot or instability. The tilt is caused by phase shift, which at this frequency is approximately 5° .

In B, the input and output wave shapes are almost identical.

In C, made at 20,000 cps, overshoot and ringing characteristics are shown. Overshoot amounts to approximately 15%. Ringing frequency is approximately 90 kc. Bear in mind that a fundamental square wave test at 20 kc will accurately predict the amplifier performance from that frequency up to at least 200 kc. No known source of program material even remotely approaches this rigorous test of high-frequency transient response.

OVERLOAD RECOVERY:

Particular attention has been given to this problem in the W-5M. Whereas high-frequency instability is generally blamed for many ills in a high fidelity amplifier, we feel that a far more important field is that of low-frequency overload and instability, for these defects are audible, even to the untrained observer. They are much more prevalent than is commonly believed, in fact, most people listening to a really wide-range system with a stable bass response characteristic are immediately impressed by the tremendous sense of freedom and drive in the reproduced sound.

Overload is a very common condition, even in power amplifiers with considerable power output. It may be caused by the sudden voltage "thump" developed by tuning an FM receiver through a carrier, or by heavy bass passages in program material. Switching transients can develop tremendous signal voltages, as can the connection of an input cable while power is applied to the amplifier.

As a first step to correction, the amplifier must overload symmetrically at any frequency. Oscillogram D shows the overloaded or clipped output wave shape at 1 kc with approximately 28 watts output. Note that the clipping is perfectly symmetrical.

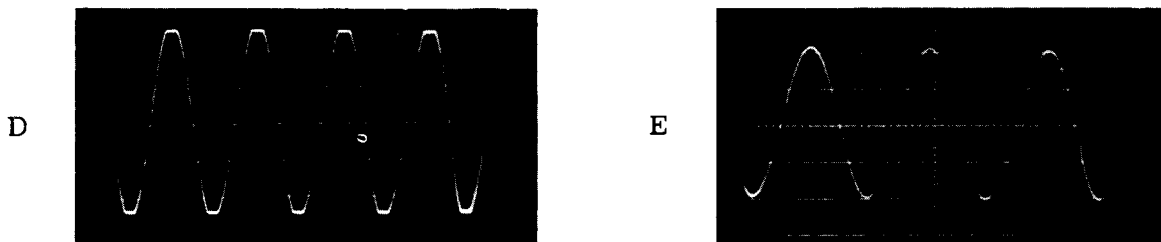

The amplifier must be capable of faithful reproduction of extremely low frequencies at normal power levels. Oscillogram E shows a 5 cycle sine wave output characteristic, taken at 1 watt level. No evidence of breakup or overload is present. No equipment was available to measure harmonic distortion at this frequency; distortion is obviously quite low.

Power supply regulation, output transformer design and careful shaping of the overall frequency response curve all play very important parts in the ability of the amplifier to recover quickly when overloaded. There is no simple or easy way to specify the overload recovery capability and the problem is made more complicated by the transient nature of the condition. In order to present a meaningful specification, we have resorted to oscillograms of simulated conditions which are known to create the condition. These are shown directly below.

The test signal shown in oscillogram F is a composite of three signals as defined in the sketch below:

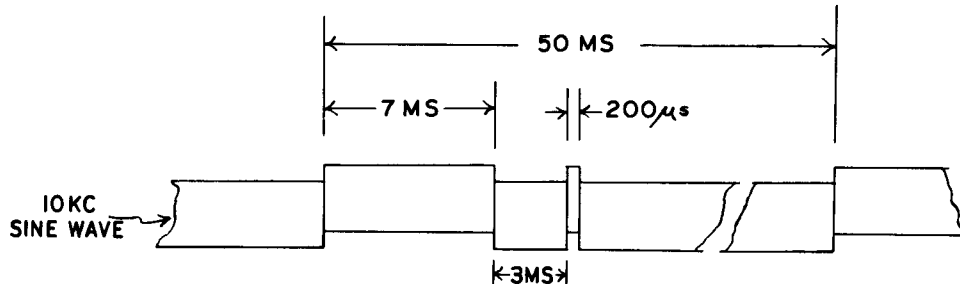

The 10 kc component represents normal mixed program material. The heavy 7 millisecond rectangular pulse simulates an overloading transient of sufficient length to show up any "ringing" or "hangover" effect following the sharp rise in signal level. The short 200 microsecond pulse follows this component after 3 milliseconds. This pulse could be placed at any point on the waveform. Its purpose was to determine if overload recovery was sufficient to faithfully present a short transient immediately following overload. The composite test signal is shown in oscillogram F. (Again, remember that the upper trace is the input signal; the lower trace is the output of the amplifier.) In order to show the critical portion of the cycle more clearly, oscillogram G is a 5 times expansion of the trace. Vertical sensitivity of the lower trace of the oscilloscope was 20 volts per centimeter or approximately 20 volts peak-to-peak. Under these conditions, the amplifier is operating safely below the overload point.

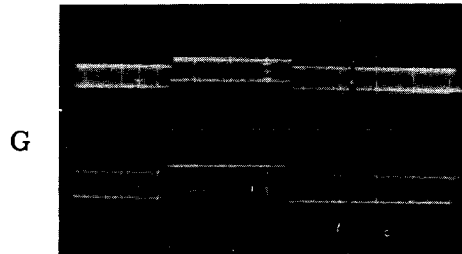
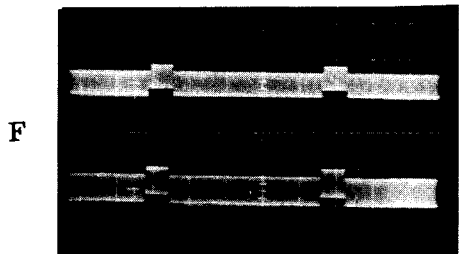

At H, the same test signal has been increased in amplitude; the amplifier is now trying to produce an output signal of some 40 volts peak-to-peak. Again, J represents a 5 times expansion of the same condition.

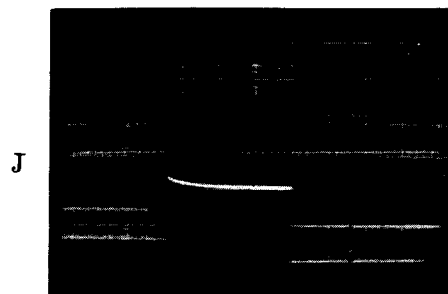
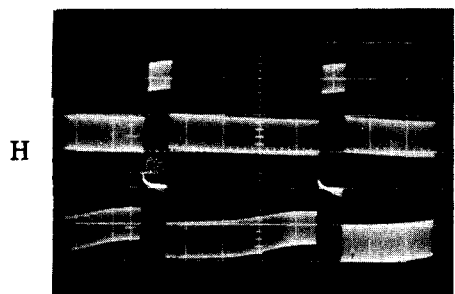

Observe at H, that the overloading transient has completely lost its identity because of output limitation. However, the recovery of the amplifier is smooth and gradual, without hangover or ringing. The short pulse is reproduced faithfully, even during the gradual recovery, which is particularly important. This effect is shown quite plainly at J.

STABILITY:

The W-5M may be operated with no load without damage to amplifier, output transformer or tubes. A built-in "Tweeter-Saver" prevents high-frequency oscillation under abnormal conditions, which might destroy or overheat high-frequency drivers in multiple-speaker systems.

Shunt capacities of up to 0.05 μ fd across speaker line cause no tendency toward instability or oscillation.

Series inductance in speaker line causes no tendency toward instability or oscillation.

MECHANICAL PROTECTION:

Decorative top cover prevents contact to hot tube envelopes; keeps connecting cables from damage by heat; "child-protects" normally exposed portions of the equipment. Cover may be readily removed without tools. Cover may be reversed, front to back, if desired. All controls, connectors and fuses on one apron of the chassis.

FINISH: Chassis, satin gold enamel. Cover, satin-texture black.

MOUNTING PROVISIONS:

Must be mounted with KT-66 bases down. See template for space requirements. Heavy mar-proof rubber mounting feet to protect mounting surface. Mounting bolts and T-nuts furnished; can be mounted on any surface up to 7/8" thick.

POWER REQUIREMENTS: 105-125 volts 50-60 cycles, 140 watts

WEIGHT: 26.5 lbs. net

TEST CONDITIONS:

- Output Impedance..... Dummy load, 16.43 Ω (cold) resistive.
- Line Voltage..... 117 volts, 60 cycles, regulated.
- Accessories..... All measurements made while the amplifier was furnishing power to a Heathkit WA-P2 Preamplifier.
- Generators..... For harmonic distortion measurement, Krohn-Hite model 440-A, inherent distortion less than 0.1%.
For frequency response measurements, Hewlett-Packard model 650-A test oscillator.
For square wave tests, Tektronix type 105 square wave generator.
- Distortion..... Total harmonic distortion measurements, Hewlett-Packard model 330-B distortion analyzer.
Intermodulation distortion; Measurements Corporation model 31 intermodulation meter, Heathkit AA-1 audio analyzer.
- Power Output..... Voltage measurements across 16.43 Ω resistive load, using Hewlett-Packard model 400-D vacuum tube voltmeter.
- Oscillograms..... Fairchild camera on Tektronix model 531 oscilloscope with type 53-C dual channel preamplifier.

INTRODUCTION

The Heathkit Amplifier model W-5M was designed to fulfill the performance requirements of the most critical audiophile, at the lowest possible cost. Up-to-the minute design techniques were used throughout to reduce distortion and at the same time, increase power output, thus allowing the connoisseur of music to enjoy a level of realism never before obtainable. The full dynamic range of all types of audio material can be handled with ease because of the high peak power handling capabilities of the W-5M.

Just a few years ago, tuners, phonograph pickups and speakers were considered as the stronger links in the audio chain and the amplifier as the weakest. The audio field has advanced tremendously in the past five years however, and now the positions are reversed. When the amplifier is constructed and adjusted in accordance with the instructions, the Heathkit model W-5M Amplifier will faithfully reproduce all program material fed to it, providing optimum performance from all other parts of the high fidelity system.

It is logical to assume that best performance will be obtained with the highest possible quality accessory components. The Heath Company cannot recommend specific components, but it is suggested that reference be made to catalogs and magazines concerned with the audio field. In general, the higher the price of the components, the higher the quality, but this is not necessarily always true. Careful shopping will usually locate very satisfactory items at a price to fit the budget.

CIRCUIT DESCRIPTION

The basic circuit of the W-5M amplifier is straightforward and simple. Signal from the program source is fed into the input jack, which is coupled to the grid of the input 12AU7 tube through a .1 μ fd condenser. Signal amplification takes place in the first half of this tube and the output is directly coupled to the grid of the second half of the tube.

Phase splitting or signal inversion is accomplished in the second half of the first 12AU7, which is a split load type of inverter. Signal at the cathode of this stage follows the grid, while the plate voltage will swing in the opposite direction. Coupling to the grids of the second 12AU7 push-pull driver stage is through .1 μ fd capacitors, one connected to the cathode and the other to the plate of the phase inverter.

Amplification of the signal takes place once again in the 12AU7 driver stage and signal is taken out through two 1 μ fd condensers, one connected to each plate of the driver. The opposite end of these condensers is connected to the grids of the output tubes. Here, the signal voltage variations are converted to large current changes in the output tubes and the output transformer, which is in the plate circuit. AC current variations in the high impedance primary of the transformer are passed to the low impedance secondary and to the speaker line connected at this point.

Feedback is applied from the secondary of the output transformer back to the cathode of the input 12AU7 stage to reduce distortion and lower the output resistance of the amplifier, thus improving amplifier control over loudspeaker performance. Inverse feedback also improves the frequency range of the amplifier.

In order to reduce harmonic distortion at low frequencies it is essential that the plate current of the output tubes be balanced. An exclusive balancing circuit is incorporated in your Heathkit amplifier to make the balancing operation easier and much more accurate. Precision balanced resistors are connected in the cathode circuits of the power output tubes. When the current in each tube is balanced, the voltage drop across each precision resistor will be the same and the resultant potential will be zero if measured at both cathodes at the same time. A great advantage is gained, since the current in both tubes is measured simultaneously instead of one at a time.

A load limiting device is built into the amplifier to provide high frequency and transient stability. Rising impedance effects of speaker systems at higher frequencies will frequently cause oscillation in a feedback type amplifier, since the amplifier fails to see a reasonable load at these frequencies. To counteract this, a resistor and condenser have been installed in series across the output transformer secondary. The condenser is chosen to prevent the loading of the amplifier throughout the audible portion of the spectrum and still provide suitable loading above these frequencies; thus assuring complete stability under all dynamic operating conditions.

Power for the amplifier is supplied by a husky power transformer and a high current ruggedized 5R4GY rectifier. Output from the 5R4GY is very well filtered in an inductance-resistance-capacity filter to keep noise and low frequency instability at a minimum. High capacity filter sections are used throughout to reduce power supply impedance at low audio frequencies. Well regulated high voltage at high current is available for the output stage, allowing high power output at very low distortion.

Only the highest possible quality components have been incorporated in the Heathkit model W-5M Amplifier. At no point have corners been cut to reduce cost at the expense of quality parts or performance. All components are conservatively rated, giving assurance of trouble-free performance for a long time. An example of the conservative rating of parts is the 5R4GY rectifier. Another type of rectifier was considered and was actually used in the original development model. While this tube was adequate for the purpose, it was operating near maximum ratings and so the decision was made to use the more expensive and rugged 5R4GY instead. A high safety factor is used in the filter section of the power supply also. The electrolytic filter condensers are connected in series with voltage balancing resistors across them, providing a maximum voltage rating of 900 volts at the first two sections of the filter, where the operating voltage is in the neighborhood of 500 volts and 700 volts at the output section, where the operating voltage is 470 volts. Special single section condensers could have been used, but it would be impossible to employ them and provide the safety factor obtained by using series units. The amplifier cover is another advantage, in that the appearance is improved and small children are protected from severe burns since they cannot touch the output tubes and rectifier, which run quite hot.

NOTES ON ASSEMBLY AND WIRING

Your Heathkit Amplifier, model W-5M represents a substantial outlay of money. In order to get the high performance return for your investment it is extremely important that you take the time to read the manual carefully before construction is started. Carefully read each step all of the way through until it is completely understood. After you are thoroughly familiar with the procedure used, construction of the kit can be started. Care exercised in construction will be rewarded with a greater sense of confidence, both in your amplifier and your own ability.

This manual is supplied to assist you in every way to complete the instrument with the least possible chance for error. The detailed instructions are specifically written to allow either the experienced or inexperienced constructor to construct the unit with a minimum of difficulty. Only a very small percentage of Heathkit assemblers encounter any difficulty whatsoever in completing kits of this kind. Large fold-in pictorial diagrams are included in the manual for your convenience and are quite helpful if attached to the wall above your work space. The diagrams are repeated in smaller form within the manual proper. We suggest that you retain the manual in your files for future reference in the use of the amplifier and its maintenance.

UNPACK THE KIT CAREFULLY AND CHECK EACH PART AGAINST THE PARTS LIST. DO NOT DISCARD ANY PACKING MATERIAL UNTIL THIS HAS BEEN DONE. In so doing, you will become acquainted with each part and the chance of accidentally throwing away some part will be eliminated. Full size sketches of each of the parts categories appear on Page 32. Use this in checking against the parts list and in identifying any questionable components.

Components with wire pigtail leads can be conveniently sorted by inserting one of the leads into the corrugated edge of the shipping carton flap. It may be helpful to mark the value of the component on the flap so the part may be readily located when needed.

If some shortage is found in checking the parts, please notify us promptly and return the inspection slip with your letter to us. Hardware items are counted by weight. An occasional shortage occurs and if this is true in your kit, please obtain the missing parts locally if at all possible.

Resistors and controls generally have a tolerance rating of $\pm 20\%$ unless otherwise stated in the parts list. Therefore, a 100 K Ω resistor may test anywhere from 80 K Ω to 120 K Ω and still be acceptable. Tolerances on electrolytic condensers may be even wider and commonly run from +100% to -50%. The parts furnished with your Heathkit have been specified so as to meet the performance specifications given.

In order to expedite delivery to you, we are occasionally forced to make minor substitutions of parts. Such substitutions are very carefully checked before they are approved and the parts supplied will work satisfactorily in your kit. For example, if your kit is short a 15 K Ω resistor and an 18 K Ω resistor is furnished which is not on the parts list, you will understand that such a substitution has been made. This fact is mentioned here only to prevent any confusion in checking the contents of your kit.

CAUTION: We strongly urge that you follow the wiring and parts layout shown in this manual. The position of leads and parts is quite critical in the instrument and changes may seriously affect the characteristics of the circuit. We do not represent that the circuit or layout of the instrument cannot be improved; however the methods shown in this manual are the result of many experimental models and unless the constructor has access to full laboratory facilities, we recommend that they be followed very closely.

STEP-BY-STEP ASSEMBLY INSTRUCTIONS

In assembling the kit, use lockwashers under all nuts, unless otherwise specified. Tube sockets are mounted inside the chassis except for miniature 9-pin shielded sockets, which are mounted on top. The insulated filter condenser mounting wafers are mounted on top of the chassis. Other details of construction are included where pertinent in the instructions.

(-) Place the chassis with the open side up in front of you on your workbench. Be sure that the apron with the holes in it is nearest you. See Figure 8 on Page 13.

(-) Mount a 9-pin miniature tube socket at location V1, using 3-48 hardware with lockwashers. Use the chart on Page 32 to identify hardware sizes if necessary. The body of the socket should be outside the chassis, with the lugs extending up through the socket hole. Orient the socket so the blank space is positioned as shown in Figure 8.

(-) In the same fashion, mount 9-pin miniature socket at V2.

NOTE: In the following steps, do NOT use the 6-32 x 1/2" screws until called for.

(-) Install an octal socket at V3, using 6-32 hardware. Be sure that a 1-lug terminal strip is mounted on one screw as shown in Figure 8. Position the keyway of this socket to the left as shown.

(-) Similarly, install octal socket V4 and terminal strip F, with keyway oriented in the same position.

(-) Mount octal socket V5. Note that the keyway for this socket is to the right. No terminal strips are used on this socket.

(-) Outside the chassis, install insulated condenser mounting wafer at G, using 6-32 hardware. Be sure that the wafer is mounted outside the chassis.

(-) In the same manner, mount a second insulated condenser mounting wafer at location H. This wafer also mounts outside the chassis.

(-) Insert a 3/8" rubber grommet in the chassis hole at R.

(-) Insert a 3/8" rubber grommet in the front apron of the chassis at FF.

(-) Insert 3/4" rubber grommets at locations S and T.

(-) Mount a 2-lug terminal strip A and three dual-lug terminal strip B, using the hole to the left of socket V1. Use 6-32 hardware.

(-) Mount three dual-lug terminal strip C, between sockets V1 and V2, using 6-32 hardware.

(-) Mount 4-lug terminal strip X directly below terminal strip C. Use 6-32 hardware.

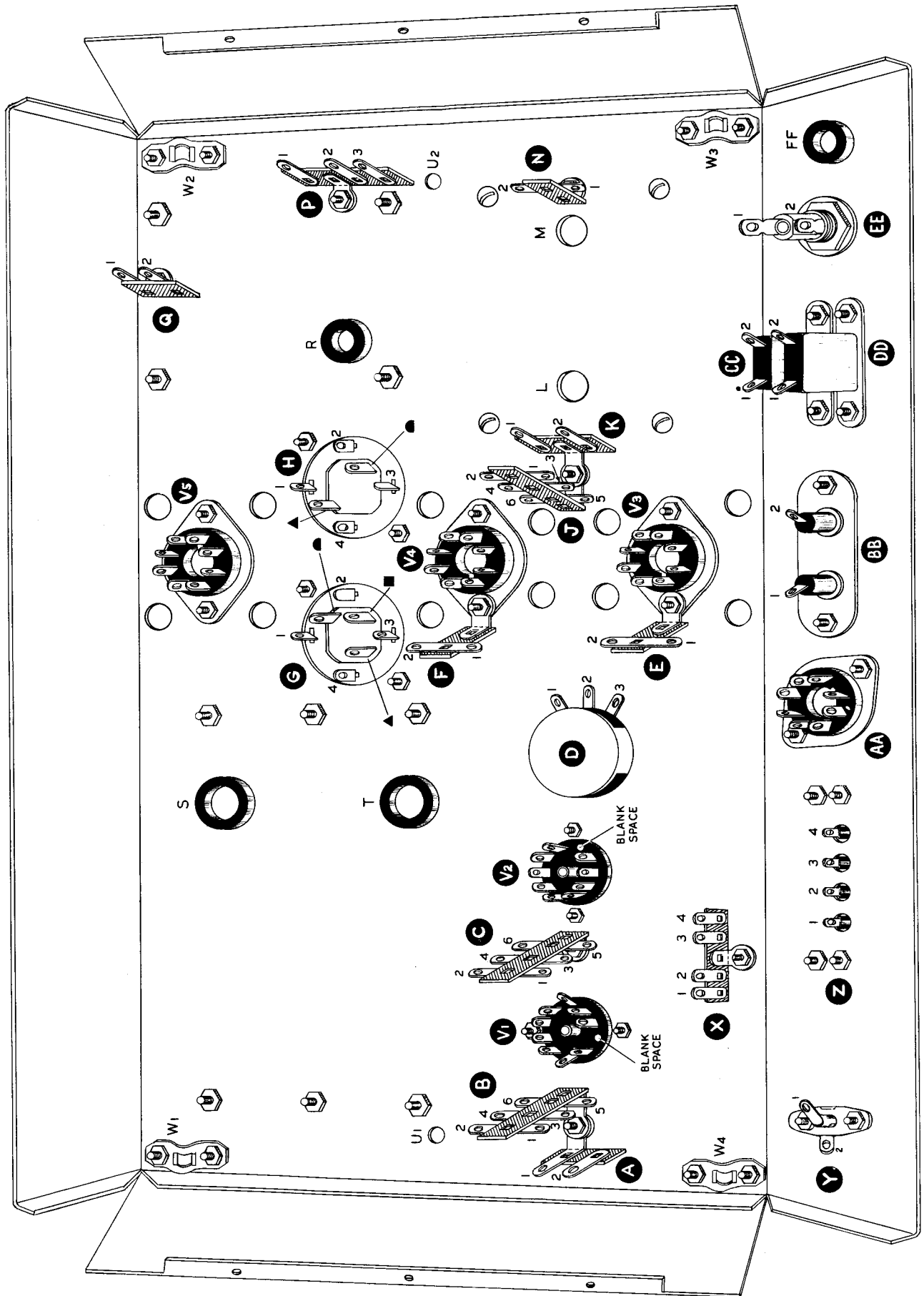

Figure 8

- (+) Install three dual-lug terminal strip J and 2-lug terminal strip K between sockets V3 and V4. Use 6-32 hardware.
- () Install one dual-lug terminal strip N as shown in Figure 8. Use 6-32 hardware.
- () Directly above terminal strip N, there is a staggered row of four holes. Using the fourth and smallest hole, mount 3-lug terminal strip P, using 6-32 hardware.
- (+) In each corner of the chassis, you will find a group of three holes. In these locations, W1, W2, W3 and W4, mount the four cover spring clips, using 4-40 pan head screws, lockwashers and nuts.
- (+) On the front apron of the chassis, mount the phono connector socket at location Y, being sure that the ground lug is to the left, nearest the end of the chassis. Use 6-32 hardware.
- (-) Cut four lengths of insulated sleeving (spaghetti) to a length of 3/8" each. Identify the molded 4-terminal speaker connector block. Slip a length of sleeving over each of the solder lugs, so that 1/8" of the tip of the lug is exposed.
- (+) Mount the connector block at location Z using the four 6-32 x 1/2" screws.
- (+) Mount the remaining octal socket at location AA on the front apron. Position the keyway nearest the edge of the apron. Use 6-32 hardware.
- (+) Mount the dual tip jack strip BB, inside the chassis.
- (+) Install AC outlet CC nearest the bend, using 6-32 hardware.
- (-) Install AC outlet DD directly above in the same way.
- (+) Following Figure 9, mount the fuse holder at EE. Position the contact lugs as shown in Figure 8. Install the fuse in the holder.
- (-) Install the 300 Ω "Bass-Bal" control at D. Follow Figure 10 for assembly details and orient terminals as shown in Figure 8.

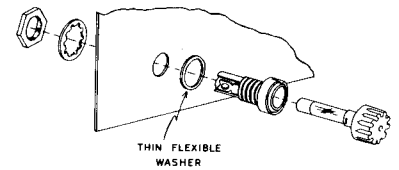

Figure 9

- (-) Identify the power transformer, the largest of the three metal cased components. Note that the leads come out in two groups, one containing red, red-yellow and yellow wires; the other containing black, green and green-yellow wires. Pass the red, red-yellow and yellow wires through grommet S and the other group through grommet T. Secure the transformer to the chassis, using six 8-32 screws, lockwashers and nuts.

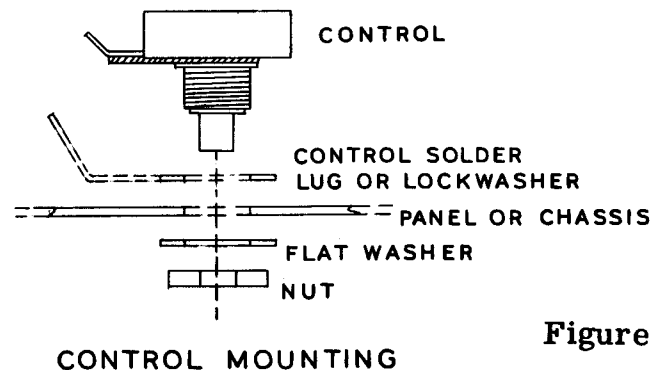

Figure 10

- (-) Identify the filter choke, the component with two wires coming through a single bushing. Pass these wires through grommet R and secure the choke in place with 8-32 hardware through the four corner holes in the mounting flange.
- () Now install 2-lug terminal strip Q, placing a 6-32 screw through the choke flange, chassis and strip bracket, as shown in Figure 8.
- (-) The remaining metal cased component is the output transformer. Through one bushing extends a group of five leads, color-coded red, brown, brown-white, blue and blue-white. Pass this group through hole M and pass the group of four leads through hole L. Secure the transformer to the chassis, using four 8-32 screws driven directly into the tapped inserts of the transformer case. Use lockwashers under each screw head.
- (-) Identify the 20-20-20 μ fd 450 volt filter condenser. This is the metal can with three terminals protruding through the insulating wafer at one end. Note that each terminal is identified by a symbol punched through the insulator adjacent to the lug. Orient these terminals as shown in Figure 8, slip the four mounting lugs through the slotted holes in the wafer at G. Then twist each lug approximately 45° to secure the condenser to the wafer. Be sure the condenser is held firmly against the wafer while twisting the lugs.
- () In the same way, mount the 40-40 μ fd 450 volt filter condenser at H. Again, orient the lugs as shown in Figure 8 before twisting the mounting tabs.

This concludes the mechanical assembly of your Heathkit model W-5M Amplifier.

STEP-BY-STEP WIRING INSTRUCTIONS

Pictorial 1 represents a completely wired W-5M amplifier. We again suggest that before you start wiring, you attach the large fold-in version of this pictorial to the wall above your work space, so that it may be conveniently referred to as the work progresses.

Read the note on the inside rear cover concerning wiring and soldering.

NOTE: ALL GUARANTEES ARE VOIDED AND WE WILL NOT REPAIR OR SERVICE INSTRUMENTS IN WHICH ACID CORE SOLDER OR PASTE FLUXES HAVE BEEN USED. WHEN IN DOUBT ABOUT SOLDER, IT IS RECOMMENDED THAT A NEW ROLL PLAINLY MARKED "ROsin CORE RADIO SOLDER" BE PURCHASED.

In Pictorial 1, note that each component part has been given a code designation which corresponds with the identification used during the assembly of the kit. In addition, each terminal on each part has been assigned a number.

When the instructions read, "Connect one end of a 1 μ fd condenser to V2-6 (NS)," it will be understood that the connection is to be made to contact pin 6 on socket V2. The abbreviation "NS" indicates that the connections should not be soldered as yet, as other leads will be added to the same terminal later. When the last wire is connected, the terminal should be soldered and the abbreviation "S" is used to indicate this.

Unless otherwise indicated, all wire used is insulated. Wherever there is a possibility of the bare leads on resistors and condensers shorting to other parts or to chassis, the leads should be covered with insulated sleeving. This is indicated in the instructions by the phrase "use sleeving." Bare wire is used where the lead lengths are short and the possibility of short circuits non-existent. Use small diameter bare wire except where otherwise specified.

Leads on resistors, condensers and transformers are generally much longer than they need to be to make the indicated connections. In these cases, the excess leads should be cut off before the part is added to the chassis. In general, the leads should be just long enough to reach their terminating points. Not only does this make the wiring much neater, but in many instances the excessively long leads will actually interfere with proper operation of the instrument.

The pictorials indicate actual chassis wiring, designate values of the component parts and show color coding of leads where pertinent. We very strongly urge that the chassis layout, lead placement and grounding connections be followed exactly as shown. While the arrangement shown is probably not the only satisfactory layout, it is the result of considerable experimentation and trial. If followed carefully, it will result in a stable instrument operating at a high degree of dependability.

- () Twist together the two green leads coming through grommet T. Place them to reach socket V4 and cut one lead to length sufficient to reach V4-2. Cut the other lead to length to reach V4-7. Save the cut-off leads. Strip and tin the leads. Connect either lead to V4-2 (NS) and the other to V4-7 (NS). (See Figure 12 for tube socket contact numbering.)
- () Twist together the two black leads coming through grommet T. Dress this pair to socket AA, using the route shown in Pictorial 1 on Page 16. Cut one lead to reach AA7 and the other lead to reach AA8. Strip and tin the ends.
- () Cut a length of Spirashield (the spring-like flexible tube) to a length of 4 3/4" and slip this over the twisted black leads. Following Pictorial 1 carefully, dress the shielded leads to the left of terminal strips E and F.
- () Cut a 1 1/2" length of bare wire and fold it in half to form a hairpin. Push the open end through the hole in the bracket for terminal strip F. Let the closed end extend horizontally to the left of the bracket and solder the hairpin in place.
- () Similarly, connect a hairpin to the bracket for terminal strip E and solder it in place.

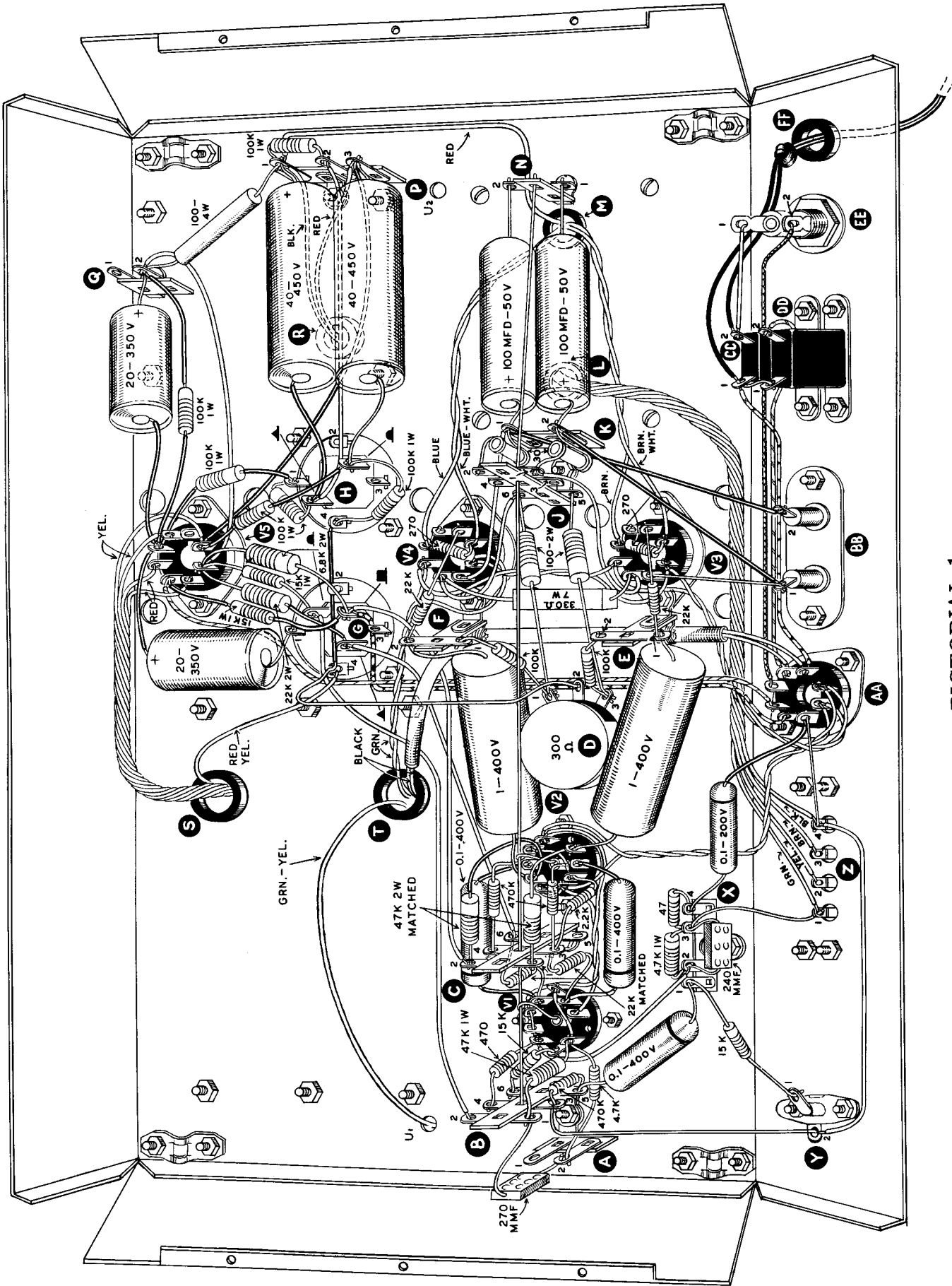

PICTORIAL 1

- () Now dress the shielded pair tightly against the two terminal strip brackets, form the two bare wires over the shield and solder them to the shield. When properly completed, this procedure will secure the shield tightly against the chassis and the two terminal strip brackets. Refer to Figure 11 for details.

Figure 11

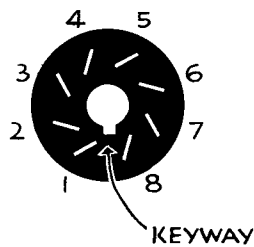
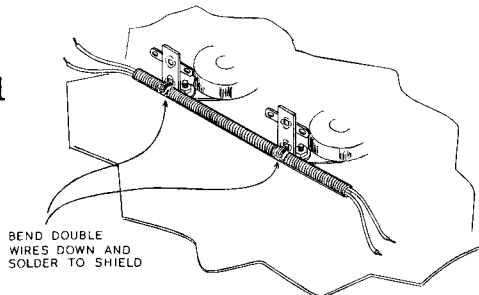
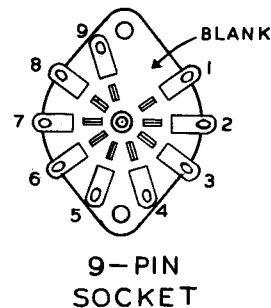

Figure 12



9-PIN SOCKET

- () At the apron end of this pair, connect either wire to AA7 (NS) and the other wire to AA8 (NS).
- () Pass the free end of the green-yellow wire coming through grommet T, up through hole U1 temporarily. Hole U1 is at the left end of the chassis. Further instructions concerning this lead will appear later.
- () Twist together the two yellow and two red wires coming through grommet S and dress the cable up to the rear apron and along the bend of the chassis to socket V5. Cut either red wire to length to reach V5-4 and the other red wire to reach V5-6. Cut either yellow wire to reach V5-2 and the other yellow wire to reach V5-8. Strip and tin all four ends. (See Figure 12 for tube socket numbering details.)
- () Connect the first red wire to V5-4 (S).
- () Connect the second red wire to V5-6 (S).
- () Connect the first yellow wire to V5-2 (NS).
- () Connect the second yellow wire to V5-8 (S).
- () Using diagonal cutters, cut a notch in mounting lug G4 on condenser G. See Figure 13.

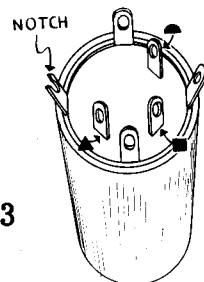

Figure 13

- () Dress the red-yellow wire coming through grommet S to condenser ground lug G4, strip and tin and connect to G4 (NS). The notch in this terminal is used in subsequent wiring.
- () Dress the red wire coming through grommet M on the output transformer along the bend in the chassis and to terminal strip P. Cut the lead to length to reach P1, strip, tin and connect the wire to P1 (NS). Be sure that this lead is dressed into the bend of the chassis as shown in Pictorial 1.
- () Twist together the blue and blue-white wires coming through grommet M and dress them toward socket V4. Cut the blue wire to length to reach V4-3 and the blue-white wire to V4-6. Strip and tin both leads. Connect the blue wire to V4-3 (S) and the blue-white wire to V4-6 (NS).
- () Twist together the brown and brown-white wires coming through grommet M and dress them toward socket V3. Cut the brown wire to length sufficient to reach V3-3 and the brown-white wire to length to reach V3-6. Strip and tin both leads and connect the brown lead to V3-3 (S). Connect the brown-white lead to V3-6 (NS).
- () Carefully dress the two pair of leads just connected so that they lie snugly against the chassis. These leads will carry the highest signal voltages in the amplifier and it is important that they be kept as close to the chassis as possible.
- () Twist together the four leads coming through grommet L. As shown in Pictorial 1, dress the cable along the front bend of the chassis toward speaker terminal block Z. Cut the green lead to length to reach Z1, yellow lead to reach Z2, brown lead to reach Z3 and black lead to reach Z4. Strip and tin all four leads. Connect the green lead to Z1 (NS). Connect the yellow lead to Z2 (S). Connect the brown lead to Z3 (S). Connect the black to Z4 (NS).
- () At the filter choke, dress the red wire coming through grommet R to terminal strip P. Cut and strip the lead and connect it to P3 (NS). Connect the black lead to P1 (NS).

- () Select the two lengths of green transformer lead cut in the first step of the wiring instructions. Cut each lead to a length of 4 1/2" and strip and tin all four ends. Offset the ends about 3/4" and twist the two leads together. (See Figure 14.)
- () At one end of this pair, connect the longer lead to V4-2 (S).
- () Connect the adjacent lead to V4-7 (S).
- () At the other end of this pair, connect the shorter lead to V3-2 (NS).
- () Connect the adjacent lead to V3-7 (NS).
- () Cut a pair of 6" lengths of hookup wire, strip all four ends and twist the two leads firmly together.
- () At one end of this pair, connect either lead to V3-2 (S) and the adjacent lead to V3-7 (S).
- () Dress the pair along the chassis bend, under socket AA and up the left side of AA. Connect either lead to AA1 (NS) and the adjacent lead to AA2 (NS).
- () In the same fashion, form a 7" long twisted pair of hookup wire. Strip all four ends. At one end of this pair, connect either lead to AA1 (S) and the adjacent lead to AA2 (S).
- () Dress this pair down along the left side of socket AA to the chassis, along the chassis bend to the left and directly up to socket V2. At the socket, connect either lead to V2-9 (NS). Connect the other lead through V2-4 (NS) to V2-5 (S).
- () Cut and strip a pair of 3 1/2" lengths of hookup wire. Offset the ends about 3/4" and twist the two leads together as before. (See Figure 14.) At one end of this pair, connect the longer lead to V2-9 (S) and the adjacent shorter lead to V2-4 (S).
- () At the other end of this pair, connect the shorter wire to V1-9 (S). Connect the adjacent longer lead through V1-5 (NS) to V1-4 (S). Now solder V1-5.
- () Connect a wire from socket AA7 (S) to AC outlet DD2 (S).
- () Connect a wire from AA8 (S) to AC outlet CC1 (NS).
- () Connect a short bare wire from CC1 (NS) to DD1 (S).
- () Using bare wire and sleeving, connect CC2 (NS) to fuse holder EE1 (S).
- () Connect a wire from AA6 (S) to EE2 (S).
- () Connect a wire from AA5 (S) to V5-5 (NS). Dress this wire under the Spirashield and the green twisted pair, as shown in Pictorial 1.
- () Similarly, run a wire from AA4 (S) to G ■ (NS).
- () Connect a bare wire from AA3 (NS) to Z4 (NS).
- () Connect a wire from Z4 (S) to the phono connector Y2 (NS).
- () Connect one lead of a 0.1 μ fd 200 volt condenser to AA3 (S) (use sleeving). Connect the other lead of this condenser to terminal strip X4 (NS).



Figure 14

NOTE: Some condenser manufacturers use a marking to identify the "outside foil" of a condenser. Usually this appears as a band around the body of the component, near one end. In this instrument, this distinction is not important. Therefore, the outside foil markings may be disregarded or if the constructor has a preference, he may use his own judgment. **IMPORTANT: THIS DOES NOT REFER TO MARKINGS ON ELECTROLYTIC CONDENSERS WHERE POLARITY IS CRITICAL.**

- () Connect a wire from G ▲ (NS) on the filter condenser to terminal strip B2 (S). Dress this lead against the chassis.
- () Connect a wire from G ■ (NS) on the filter condenser to terminal strip C2 (NS). Dress this lead against the chassis.
- () Connect a wire from G ▲ (NS) on the filter condenser to terminal strip C6 (NS). Dress this lead against the chassis.
- () Using bare wire and sleeving, connect a lead from P3 (NS) to V5-2 (NS). Sleeving is used on this lead for maximum voltage breakdown protection.
- () Connect a wire from V5-3 (NS) to terminal strip Q2 (NS).
- () Connect a wire from filter condenser H ▲ (NS) to P2 (NS).

- +) Connect a 100 Ω 4 watt resistor (large ceramic body) from terminal strip Q2 (NS) to P1 (NS).
- +) Connect a 100 K Ω 1 watt resistor (medium body, brown-black-yellow) from P1 (NS) to P2 (S).
- +) Connect a 100 K Ω 1 watt resistor from H \blacktriangle (NS) to H4 (NS).
- +) Connect a 100 K Ω 1 watt resistor from H \blacktriangle (NS) to H1 (NS).
- +) Connect a 100 K Ω 1 watt resistor from V5-2 (S) (use sleeving) to H \blacktriangle (NS) (use sleeving).
- +) Connect a 100 K Ω 1 watt resistor from V5-7 (NS) (use sleeving) to H1 (S) (use sleeving).
- +) Connect a 100 K Ω 1 watt resistor from V5-7 (NS) (use sleeving) to Q2 (NS) (use sleeving).
- +) Connect a 20 μ fd 350 volt electrolytic condenser from V5-7 (NS) (use sleeving) to G1 (S). The positive end of the condenser connects to V5-7.
- +) Connect a 20 μ fd 350 volt electrolytic condenser from V5-7 (S) (use sleeving) to Q2 (S). The positive end connects to Q2.
- +) Connect a 40 μ fd 450 volt electrolytic condenser from P1 (S) to H \blacktriangle (S) (use sleeving). The positive end connects to P1.
- +) Connect a 40 μ fd 450 volt electrolytic condenser from P3 (S) to H \blacktriangle (S). The positive end connects to P3.
- +) Connect a 15 K Ω 1 watt resistor (medium body, brown-green-orange) from V5-3 (NS) to G \blacktriangle (S).
- +) Connect a 6.8 K Ω 2 watt resistor (large body, blue-gray-red) from V5-3 (NS) to G \blacksquare (NS).
- +) Connect a 22 K Ω 2 watt resistor (large body, red-red-orange) from V5-3 (S) to G \blacktriangle (S) (use sleeving).
- +) Connect a 15 K Ω 1 watt resistor (medium body, brown-green-orange) from V5-5 (S) (use sleeving) to G \blacksquare (S) (use sleeving).
- +) Connect a 100 μ fd 50 volt electrolytic condenser from N2 (S) to K1 (NS). The positive lead connects to K1.
- +) Connect a 100 μ fd 50 volt electrolytic condenser from N1 (S) to K2 (NS). The positive lead connects to K2.
- +) Connect a 270 Ω 1/2 watt resistor (small body, red-violet-brown) from V4-4 (S) to V4-6 (S).
- +) Connect a 270 Ω 1/2 watt resistor from V3-4 (S) to V3-6 (S).
- +) Connect a 22 K Ω 1/2 watt resistor (small body, red-red-orange) from V4-5 (S) to terminal strip F2 (NS). Dress this resistor directly over the body of the 270 Ω resistor.
- +) Connect a 22 K Ω 1/2 watt resistor from V3-5 (S) to terminal strip E1 (NS). Dress this resistor over the body of the 270 Ω resistor.
- +) Connect a 330 Ω 7 watt resistor (large ceramic body) from V3-1 (NS) to V4-1 (NS). Dress the body of the resistor against the chassis between Spirashield and twisted green pair.
- +) Connect a lead from V3-1 (S) to terminal strip J1 (NS).
- +) Similarly, connect a lead from V4-1 (S) to terminal strip J6 (NS).
- +) **IMPORTANT:** Make sure that the last two leads installed do not touch any other terminal or the chassis.
- +) Connect a 100 Ω 2 watt resistor (large body, brown-black-brown) from J6 (S) to control D1 (NS). Cut the leads so that the resistor body lies between the 7 watt resistor and terminal strip J.
- +) Connect a 100 Ω 2 watt resistor from J5 (S) to control D3 (NS). Position this resistor in the same way as in the step above.
- +) Using bare wire and sleeving, connect a wire from V4-8 (S) to terminal strip K1 (NS).
- +) Connect a bare wire from V3-8 (S) to "Bass-Bal" jack BB1 (NS).
- +) Using bare wire and sleeving, connect a wire from BB1 (S) to terminal strip K2 (NS).
- +) Using bare wire and sleeving, connect a wire from BB2 (S) to terminal strip K1 (NS).
- +) Connect a 30 Ω precision resistor (medium tubular body) from J2 (S) to K1 (S).
- +) Connect a 30 Ω precision resistor from J1 (S) to K2 (S).
- +) **IMPORTANT:** Make sure that the last two resistors installed do not touch J2, J4, the mounting screw for J and K or any other metallic part. Do not rely on the insulating enamel of the resistors for protection against shorts.
- +) Connect a 100 K Ω 1/2 watt resistor (small body, brown-black-yellow) from D3 (S) to terminal E2 (S).
- +) Connect a 100 K Ω 1/2 watt resistor from D1 (S) to terminal strip F1 (S).
- +) Recheck the two **IMPORTANT** steps on this page. The power transformer can be permanently damaged if these precautions are NOT taken.

NOTE: JUMPERS BETWEEN V1-1 & V1-7, AND
V2-3 & V2-8 NOT SHOWN TO PREVENT CONFUSION

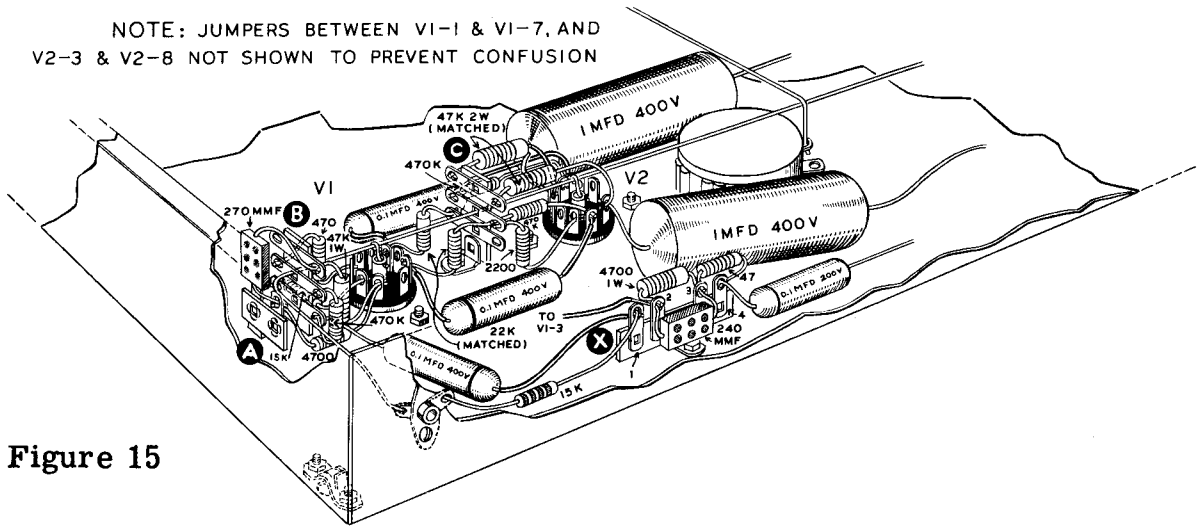

Figure 15

NOTE: Refer to Figure 15 while wiring sockets V1 and V2 for details of component placement.

-) Using bare wire and sleeving, connect a jumper from V2-3 (NS) to V2-8 (S).
-) Connect a 2.2 K Ω 1/2 watt resistor (small body, red-red-red) from terminal strip C3 (NS) to socket V2-3 (S).
-) Connect a 470 K Ω resistor (small body, yellow-violet-yellow) from terminal strip C4 (S) to socket V2-7 (NS).
-) Connect a 470 K Ω resistor from terminal strip C3 (NS) to V2-2 (NS).
-) Select one of the 47 K Ω 2 watt resistors (large body, yellow-violet-orange) from the envelope containing the matched pair resistors. Cut one lead of the resistor to a length of 3/8" and connect this lead to terminal strip C1 (S). Dress the resistor body horizontally to the right. Connect the other lead to V2-1 (NS).
-) In identical fashion, connect the other matched pair 47 K Ω 2 watt resistor from C2 (S) to V2-6 (NS) (use sleeving).
-) Connect a 0.1 μ fd 400 volt condenser from V1-6 (NS) (use sleeving) to V2-7 (S) (use sleeving).
-) Connect a 0.1 μ fd 400 volt condenser from V1-8 (NS) (use sleeving) to V2-2 (S) (use sleeving).
-) Connect a 1 μ fd 400 volt condenser from V2-1 (S) to terminal strip E1 (S).
-) Connect a 1 μ fd 400 volt condenser from V2-6 (S) (use sleeving) to terminal strip F2 (S).
-) Using bare wire and sleeving, connect a jumper from V1-1 (NS) to V1-7 (S).
-) Select one of the 22 K Ω 1/2 watt matched pair resistors (small body, red-red-orange). Cut one lead to a length of 1/2" and connect this lead to terminal strip C3 (S). Dress the body toward the chassis and connect the other lead to V1-8 (S).
-) Connect the remaining 22 K Ω 1/2 watt matched pair resistor, in the same way, from C6 (S) to V1-6 (S).
-) Connect a 15 K Ω 1/2 watt resistor (small body, brown-green-orange) from terminal strip B6 (S) to socket V1-2 (S).
-) Connect a 4.7 K Ω 1/2 watt resistor (small body, yellow-violet-red) from V1-1 (NS) to terminal strip A2 (NS).
-) Connect a 270 $\mu\mu$ f mica condenser (small rectangular body, six dots: black-red-violet-brown-silver-brown) from terminal strip B1 (NS) to terminal strip A2 (S).
-) Connect a 0.1 μ fd 400 volt condenser from B5 (NS) to X1 (NS).
-) Connect a 470 K Ω 1/2 watt resistor (small body, yellow-violet-yellow) from B5 (S) to B3 (NS).
-) Connect a wire from V1-3 (NS) to terminal strip X2 (NS).
-) Connect a 470 Ω 1/2 watt resistor (small body, yellow-violet-brown) from V1-3 (S) to terminal strip B4 (S).

- () Connect a 47 K Ω 1 watt resistor (medium body, yellow-violet-orange) from V1-1 (S) to terminal strip B1 (S).
- () Connect a 15 K Ω 1/2 watt resistor (small body, brown-green-orange) from phono socket Y1 (S) to terminal strip X1 (S).
- () Connect a 240 $\mu\mu\text{f}$ mica condenser (small rectangular body, six dots: black-red-yellow-brown-gold-orange) from terminal strip X2 (NS) to X3 (NS).
- () Connect a 4.7 K Ω 1 watt resistor (medium body, yellow-violet-red) from X2 (S) to X3 (NS).
- () Connect a 47 Ω 1/2 watt resistor (small body, yellow-violet-black) from X4 (S) through X3 (NS) to Z1 (S). Now solder X3.
- () Stretch the length of heavy bare wire to remove kinks. A quick way to do this is to clamp one end in a small vise and pull on the other end using pliers.

NOTE: The use of heavy wire for the connections below may seem to be quite elaborate. However, extensive experimentation has proven that the procedure is fully justified in reduced noise and increased stability. We strongly recommend that the outlined instructions be carefully followed.

- () Cut a 12" length of the heavy wire. Starting on the right, pass one end of this wire through the eyelet which stakes lugs J3 and J4 to the terminal strip insulator. Thread the wire through the center eyelets of terminal strips C and B until the end of the wire strikes the left end of the chassis. Then move the wire to the right and pass the right end through the eyelet holding lugs N1 and N2 to terminal strip N. Now solder the wire to the center eyelets on terminal strips C, J, N and B. Clip off any excess wire beyond B and N. The wire will be referred to as a ground bus.
- () Cut a 2 1/2" length of the heavy bare wire. Make a square bend 3/8" from one end. Connect this end to B3 (S). Connect the other end to phono socket Y2 (S).

Use the balance of the heavy bare wire to make the following connections:

- () Slip a 1 5/8" length of sleeving over one end of the wire. Form a small hook at the end and insert the hooked end, with the sleeving in place, under the group of resistors between socket V5 and filter condenser G. Connect the hooked end to filter condenser H4 (S). Push the sleeving snugly against H4.
- () Now carefully press the wire toward the chassis so that it rests in the notch previously cut in filter condenser G4. It may be necessary to twist the lug slightly to accept the wire. Solder the wire at G4. Do not cut off any excess wire.
- () Bend the wire straight up from G4. At a point 1" above G4, make a square bend toward socket AA. Cut the wire at a point 1 1/8" past the point where this wire intersects the ground bus. At the intersection, bend the 1 1/8" end down toward control D making sure that good contact is made to the other heavy wire. Solder the end to D2. Now solder the intersection of the two heavy wires.
- () From a point directly above the center tubular shield of socket V1, connect a short length of light bare wire from the ground bus to the shield on V1. Solder both ends.
- () Similarly, connect a short bare wire from the ground bus to the shield on V2. Solder both ends.
- () Pass the line cord through grommet FF. Inside the chassis, tie a knot about 3 1/2" from the stripped end. This is for strain relief.
- () Connect one lead to CC1 (S).
- () Connect the adjacent end to CC2 (S).

- (-) Identify the four spring-catch pins, referring to Figure 16. Mount pins at each of the four corners of the cover, using 6-32 lockwashers and nuts.
- (-) Referring to Figure 16, attach the plastic name-plate and escutcheon to the cover screen using the speed nuts provided. A suggested location is given in Figure 16. Any of the horizontal slots in the cover will accept the name-plate pins if some other location is preferred.

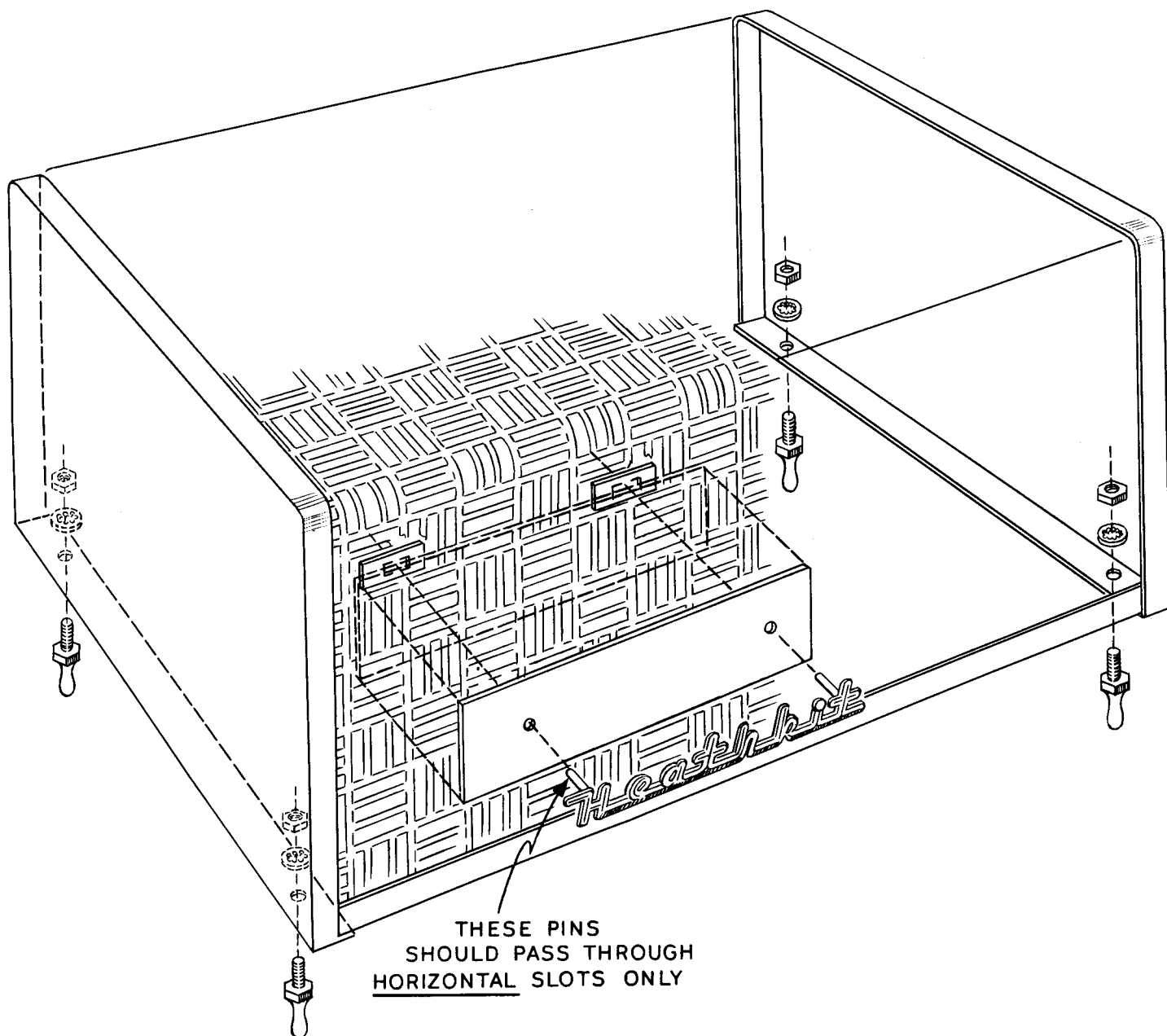

Figure 16

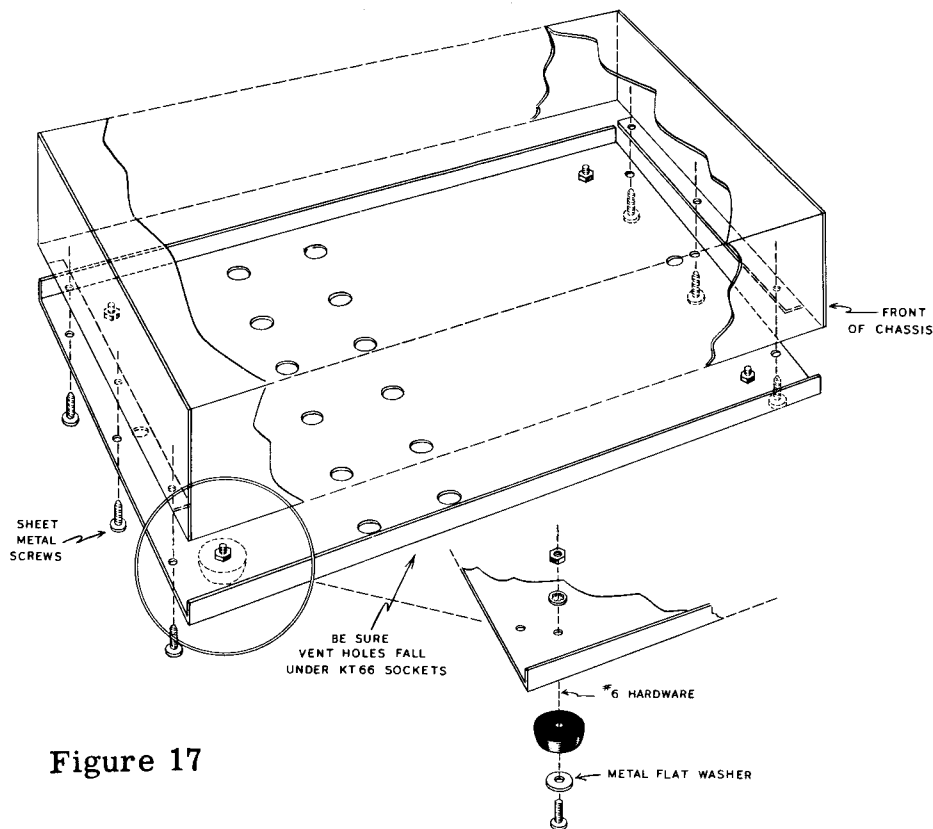

Figure 17

Now attach the four rubber feet to the bottom cover, following Figure 17 for details of the assembly. Use 6-32 hardware.

This completes the actual construction of the amplifier. Before the chassis cover and bottom plate are installed, the unit should be tested and adjusted.

IMPORTANT NOTICE

If the W-5M Amplifier is to be used with the Heathkit WA-P1 Preamplifier or with any other preamplifier which has ungrounded filaments and draws its power from the main amplifier, the green-yellow wire of the power transformer must be grounded at the power supply end of the ground bus wire in the amplifier. Any of the four ground lugs on either can-type filter condenser will be perfectly satisfactory.

Use of a separate self-powered preamplifier is permissible but the green-yellow power transformer wire should be grounded as described above to obtain the lowest possible noise figure. Pins 6 and 7 of the power socket should be jumpered with a switch or wire to apply power to the amplifier, if a preamplifier other than a Heathkit is used.

When a preamplifier with a filament hum balance control (such as the Heathkit WA-P2) is used with the W-5M, the green-yellow transformer wire should be left disconnected and taped up at the end to avoid short circuits. Dress the wire under the wires appearing through grommet S to hold it in place.

Any preamplifier requiring a separate power supply can be used with the W-5M Amplifier providing the AC and DC current drain does not exceed the ratings listed in the chart below. An adapter can be wired to supply the following voltages on a 6 or 8 conductor cable:

Pin 1 - One side of filament circuit,
6.3 volts at 1.0 amp AC
Pin 2 - Other side of filament circuit
Pin 3 - Negative plate supply
Pin 4 - Positive plate supply, 380 volts
at 5 ma DC

Pin 5 - Positive plate supply, approximately 250
volts at 10 ma DC
Pin 6 - AC switch terminal
Pin 7 - AC switch terminal
Pin 8 - AC line terminal

() Snap the top cover in place by lining the cover studs up with the appropriate holes in the chassis and pressing down gently on all four corners until firmly settled.

This completes the assembly and adjustment of your Heathkit Amplifier model W-5M. See Page 27 for Installation and Operation.

IN CASE OF DIFFICULTY

Recheck the wiring. Trace each lead in colored pencil on the pictorial as it is checked in the amplifier. Most cases of difficulty result from wrong connections. Often having a friend check the wiring will reveal a mistake consistently overlooked.

If possible, compare the tube socket voltages with those shown in the voltage table below. Readings within 20% of those shown may be considered as normal. If a discrepancy is noted, check the associated circuits carefully. Any component in those circuits should be suspected until proven satisfactory.

If voltages and tubes are normal, try the following procedure.

With the preamplifier output disconnected from the amplifier input, touch tube socket terminal V4-5 with one lead of a .01 μ fd condenser, holding the other lead in your hand. (CAUTION: Do not touch the chassis or any other metallic body with your other hand while making this test. Dangerously high voltage is present throughout the circuit and due care should be exercised.) This should cause a hum level to be evident in the speaker, if the circuit from this point is normal. Work on forward in the circuit, touching terminals V3-5, V2-6, V2-7, V2-1, V2-2, V1-8, V1-6, V1-7, V1-1 and V1-2. The hum level should increase somewhat as you work back toward the amplifier input. At some point in the amplifier, the circuit will appear to be dead and all circuitry following that stage may be disregarded in your trouble shooting. In this way, you can easily locate the source of the trouble and expedite its correction.

VOLTAGE CHART

SOCKET TUBE TYPE	Pin 1	Pin 2	Pin 3	Pin 4	Pin 5	Pin 6	Pin 7	Pin 8	Pin 9
V1 12AU7	88	NS	2.2	Fil.		280	88	100	Fil.
V2 12AU7	255	NS	13	Fil.		255	NS	13	Fil.
V3 KT66	TP 47	Fil.	480	480	*8.3	TP 485	Fil.	50	
V4 KT66	TP 12.5	Fil.	475	480	*6.7	TP 480	Fil.	50	
V5 5R4GY	NC	** 510	TP 495	455 VAC	TP 310	455 VAC	TP 240	** 510	
AA POWER	Fil.	Fil.	0	400	300	110 VAC Switch Circuit			
G CONDENSER	▲ 380		■ 400		● 350				
H CONDENSER	▲ 235		● 245						

All voltages positive DC to chassis, measured with Heathkit V-7 VTVM with 11 megohm input resistance. Voltages taken with Heathkit WA-P2 Preamplifier connected.

TP - Tie point. NS - Not significant. Line voltage - 117 volts AC.

Fil. - Voltage between points so designated, 6.3 volts AC.

* Voltages so designated will vary with changes of settings of Bass-Bal control.

** Voltages between pins 8 and 2 - 5 volts AC.

UNUSUAL TROUBLES AND CORRECTIVE PROCEDURES

Amplifier oscillation is usually indicated when the performance seems "strained" or "muddy." Intermittent performance of this type is usually a definite symptom, as is sudden change in apparent output level. To check for oscillation, it is usually a good idea to connect an oscilloscope or wide range AC VTVM across the output with the normal speaker load left connected. If these instruments are not available, checks can be made with a NE-2 neon bulb or a fluorescent bulb from a desk lamp. While holding the glass envelope of the neon bulb in one hand, touch either of the leads to pin 3 of either socket V3 or V4. Keep your other hand in your pocket or behind your back when making this check, since dangerous voltages are present at this point. If the bulb glows, the amplifier is oscillating. If a fluorescent bulb is used, touch one of the pins at one end to pin 3 of either socket, touching the pins at the opposite end of the bulb with a finger. Observe this type of bulb in a dimly lit room, since the glow will be quite dull. Any type of glow indicates oscillation.

High frequency instability is usually indicative of high wiring capacity within the amplifier. Check the wiring over carefully, making sure that none of the leads are any longer than they absolutely have to be to make the connection. Special attention should be given to the output transformer leads; they must be as short as possible and dressed tightly to the chassis. The "Tweet-er Saver" should be checked to make sure connections are correct and the parts are all right. This circuit consists of a .1 μ fd condenser and a 47 Ω resistor connected across the outside terminals of the speaker terminal strip.

If everything within the amplifier appears to be all right, it is quite likely that there is too much capacity in the speaker or input leads. Shielded wire should never be used for speaker leads, the capacity is much too high. Best results are usually obtained with heavy duty lamp cord, obtainable in any dime store. If the leads must be quite long, it might be advisable to separate the two wires to reduce capacity. For the best frequency response and stability characteristics it is recommended that the preamplifier be connected to the main amplifier with leads just long enough to satisfactorily meet the requirements of the individual installation. Excessively long audio cables will attenuate high frequencies and the high capacity may cause oscillation. Length limits are usually specified for the preamplifier by the manufacturer.

Motorboating or low frequency instability, may be caused by high frequency oscillation and the steps outlined above should be checked. Make sure the output tubes are properly balanced and that the filter condensers in the power supply are wired correctly. In rare cases, the feedback might be marginal and it will be necessary to increase the value of the feedback resistor slightly to approximately 6800 Ω . Feedback reduction will be very slight and overall performance will remain substantially unaltered with a resultant improvement in low frequency stability.

Output tubes will not balance. This condition will be caused by one of two things; a leaky 1 μ fd coupling capacitor or a seriously unbalanced pair of tubes. First the coupling condensers should be checked by connecting a high sensitivity meter such as a vacuum type voltmeter across each of the 100 K Ω grid resistors for the output tubes, V3 and V4. Any potential across this resistor indicates one of the following conditions:

- (a) If the voltage appearing at the grid end is positive, either the coupling condenser is leaky or the tube is gassy.
- (b) If the voltage appearing at the grid end is negative, the amplifier is probably in oscillation. Note that the meter is connected directly across the resistor, not from grid to ground. The grid is normally positive with respect to ground.

If the tube socket potentials are normal but balance cannot be achieved, one of the output tubes can be assumed to be weak. A replacement tube balanced against each of the original tubes should allow a satisfactory pair to be located. Balance near the end of rotation of the balance control is not abnormal and need not be cause for concern. As long as the tubes can be balanced the distortion figures will meet specifications.

Low or high frequency noise in the amplifier can usually be traced to a defective resistor or a faulty tube. The troublesome point can be located quickly by removing tubes one at a time, starting with V1, then V2, etc. When a point is found where the noise disappears, the troublesome stage has been isolated. Further checks should be made at this point by swapping identical tubes or replacing them to see if the trouble will clear up. If tube replacement fails to help, one of the resistors is probably noisy or a poor connection exists somewhere in the circuit. Noisy resistors can be located by shorting out resistances connected to tube sockets V1 and V2, starting with the input stage and working back as far as pins 1 and 6 of V2. When observing this procedure, short out the resistor in question, not between each pin of the amplifier tube socket and ground. The first point at which the noise disappears isolates the defective component. Hiss or high frequency noise is usually caused by a defective tube, resistor or connection. Hum and other types of low frequency noise is frequently due to a defective tube, poor connections, excessively long leads or improper lead dress. When checking the amplifier components with the unit turned on, observe due caution at all times. Dangerously high voltages are present throughout the circuit.

INSTALLATION AND OPERATION

The Heathkit W-5M Amplifier readily lends itself to practically any type of installation. Large rubber feet are used so that the unit can be placed anywhere without danger of marring furniture and it will not slide about even if not bolted down. For permanent installations, the unit can be fastened down with the bolts and T-nuts furnished, using the furnished template to cut the two necessary holes. Use the large fiber washers under the bolt heads to prevent marring the chassis finish. Do not remove the rubber feet if the amplifier is to be bolted down, since some air space must be provided between the amplifier and the mounting board for ventilating purposes.

When the amplifier cover is first installed, it will probably fit too tightly. It should not be possible to pick the amplifier up by grasping the cover, since the amplifier might be released suddenly causing serious damage. To adjust the cover tension, insert a screwdriver blade between the springs of the catch clips and spread them slightly until satisfactory tension is obtained.

Markings on the front apron of the chassis are self-explanatory. One suggestion; when connecting the preamplifier to the W-5M, shielded cable should be used, terminating in a standard phono plug. Full instructions for preparation of this cable are included with the Heathkit WA-P2 Preamplifier kit. Brief instructions are included here, should other equipment be used.

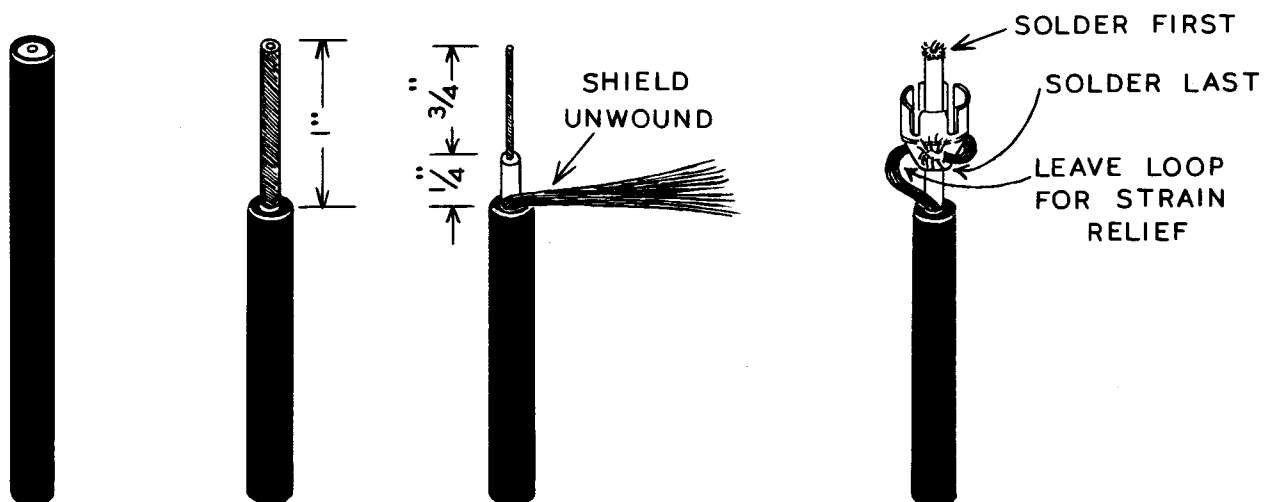

Figure 18

Follow Figure 18 above to connect the phono plug to shielded cable which has a spirally wrapped shield. Certain cables are furnished with braided shields. In such cases, unbraided the shield using a sharp pick or scribe, until sufficient conductor is available for connecting to the plug shell.

"GROUND LOOPS" IN AUDIO CABLES

Under most conditions, lower overall hum will result if the shield on the input cable is grounded to the shell only at the preamplifier end, leaving the shield completely free at the power amplifier connection. If hum is objectionable under operating conditions, experiment by reversing this cable. Occasionally, hum will develop because of ground loops between a phono pickup and the preamplifier or between other program sources and the preamplifier. Try disconnecting each input to the preamplifier in turn until the hum level drops. Then experiment by opening the ground return at each end of the cable for that particular source. As a last resort, try an independent ground conductor from each program source to a ground point, with a short heavy conductor from this point to virtual earth ground, such as a cold water pipe. Independent grounds from the preamplifier chassis and the power amplifier chassis may also help. This procedure should rarely be necessary and is mentioned only as a desperate measure. If required, an earnest investigation of the program sources is in order; leakage from their power circuits to ground is indicated. Self-powered preamps must be grounded to the W-5M chassis with a grounding wire or through the audio cable shielding.

PHYSICAL LOCATION OF THE AMPLIFIER

The amplifier should be located where it is protected from dampness, where it is readily accessible and where adequate ventilation is assured. As previously mentioned, the mounting feet space the amplifier above the mounting surface to assure free flow of air under and up through the bottom chassis cover. An inch or so of free space is required above the amplifier cover. The cover is symmetrical and may be reversed to place the controls and connectors on the rear apron if desired.

USE OF AC OUTLETS

Two AC outlets are provided on the chassis apron. The one marked AC NORMAL is not controlled by the switching circuit nor is it protected by the amplifier fuse. The outlet marked AC SWITCHED is controlled and fused. Please note that total load connected to the switched outlet should not exceed 150 watts; otherwise the fuse will blow.

We suggest that the AC NORMAL outlet be used for record changers equipped with automatic shut-off switches or other accessories for which independent switching is desired. The AC SWITCHED outlet will be convenient for tuners, tape recorders, etc. CAUTION: Do not use the switched outlet for powering professional type turntables. These units are equipped with interlocking mechanisms to lift idler pulleys from capstans and table rims when they are turned off. If the turntable switch is not used, the idlers will not be lifted and may become deformed.

GENERAL NOTES

The Heathkit W-5M Amplifier incorporates several features which might bear further discussion, although they have all been mentioned previously in this manual. Among these is the unique method used for indicating exact balance or cathode current between the KT66 output tubes. In the original treatise on the Williamson amplifier, Mr. D. T. N. Williamson stated that such balance was a "matter of some importance." The graph on Page 32 tends to support this statement.

Observe that the reduction in harmonic distortion is much more pronounced at lower frequencies becoming quite critical in the 20 cps region. The usual method for indicating balance involves connecting a milliammeter in series with each cathode return, noting the current reading and adjusting the balance control until equal cathode currents are obtained for each tube. The method is time-consuming, frequently inaccurate and requires the use of a meter not readily available.

The "Bass-Bal" method used in the W-5M permits indicating exact balance without upsetting circuit conditions, is limited in accuracy only by the sensitivity of the meter and requires only a simple voltage indicator. Accuracy of meter calibration is unimportant, since it is used only for indicating zero potential difference. Even if the meter zero adjustment is defective, the balance setting will be indicated perfectly provided the meter shows no change in deflection when connected or disconnected at the jacks. The meter may be left connected without fear of damage. It should be pointed out that adjustment is quite stable once affected and need be checked only at infrequent intervals.

This method of controlling balance also permits use of KT66 tubes with wider than average deviations in plate current and mutual conductance. Therefore, should one tube fail, it generally will not be necessary to purchase a pair of matched tubes to restore the high performance of the amplifier.

One word of caution: In connecting the meter to the "Bass-Bal" jacks, avoid contacting the chassis with either meter lead. These terminals are about 45 volts above chassis. A sensitive meter connected from them to ground might be seriously damaged.

A second innovation in the Heathkit W-5M is the inclusion of a "Tweeter-Saver." Most serious audiophiles have had the unfortunate experience of losing one or more speakers because of voice coil failure. High frequency drivers or "tweeters," have been particularly susceptible to this trouble.

Speaker manufacturers have spent a great deal of time in research to isolate the cause of these failures. One of the principal offenders has been high frequency oscillation in the power amplifier at a supersonic frequency. Generally, this takes place at frequencies near the upper "hump" in the response curve. This hump has been characteristic of many feedback amplifiers.

In the W-5M amplifier, particular pains have been taken to reduce the possibilities of instability and this peak has been eliminated. However, as added insurance the output of the amplifier is constantly monitored by the "Tweeter-Saver."

Most speaker systems are nominally rated at 4, 8 or 16 Ω impedance and present a load impedance near these figures throughout most of the audio spectrum. But, at 50 to 200 kc, these systems show impedances of several times the rated value; therefore the amplifier is not properly terminated, becomes unstable and tends to oscillate at supersonic frequencies. A substantial amount of high frequency power is fed to the speaker, it begins to overheat and fails. This may take place even though the oscillation occurs only intermittently and under continuous oscillation even the finest high frequency drivers fail in less than one minute.

The "Tweeter-Saver" will prevent these oscillations, even though no speaker is connected. A relatively small load resistor, rated at only 1/2 watt, can be used safely in the circuit, since the purpose is to prevent oscillation, not to absorb power. The circuit does present a slight loading effect at very high frequencies but this is beneficial since it improves transient characteristics and helps flatten the high frequency response of the amplifier.

In adjusting the pads to the several drivers of a multiple-speaker system, it is convenient to drive the system at single frequency inputs while measurements are made with microphone or sound-level meters. During such tests, if high frequency power is applied to the speaker accidentally, the "Tweeter-Saver" will pick up a substantial portion, thereby protecting the speaker system. The constants of the circuit have been selected to absorb power only at frequencies well above the sonic range. When making tests at high frequencies with large outputs, it is normal for the resistor to heat. Therefore such tests should be made as quickly as possible.

REPLACEMENTS

Material supplied with Heathkits has been carefully selected to meet design requirements and ordinarily will fulfill its function without difficulty. Occasionally improper instrument operation can be traced to a faulty tube or component. Should inspection reveal the necessity for replacement, write to the Heath Company and supply all of the following information:

- A. Thoroughly identify the part in question by using the part number and description found in the manual parts list.
- B. Identify the type and model number of kit in which it is used.
- C. Mention the order number and date of purchase.
- D. Describe the nature of defect or reason for requesting replacement.

The Heath Company will promptly supply the necessary replacement. Please do not return the original component until specifically requested to do so. Do not dismantle the component in question as this will void the guarantee. If tubes are to be returned, pack them carefully to prevent breakage in shipment as broken tubes are not eligible for replacement. This replacement policy does not cover the free replacement of parts that may have been broken or damaged through carelessness on the part of the kit builder.

SERVICE

In event continued operational difficulties of the completed instrument are experienced, the facilities of the Heath Company Service Department are at your disposal. Your instrument may be returned for inspection and repair for a service charge of \$5.00 plus the cost of any additional material that may be required. **THIS SERVICE POLICY APPLIES ONLY TO COMPLETED INSTRUMENTS CONSTRUCTED IN ACCORDANCE WITH THE INSTRUCTIONS AS STATED IN THE MANUAL.** Instruments that are not entirely completed or instruments that are modified in design will not be accepted for repair. Instruments showing evidence of acid core solder or paste fluxes will be returned not repaired.

The Heath Company is willing to offer its full cooperation to assist you in obtaining the specified performance level in your instrument. Factory repair service is available for a period of one year from the date of purchase or you may contact the Engineering Consultation Department by mail. For information regarding the possible modification of existing kits, the current issues of technical periodicals are recommended. They can be obtained at or through your local library, as well as at any electronic outlet store. Although the Heath Company welcomes all comments and suggestions, it would be impossible to design, test, evaluate and assume responsibility for proposed circuit changes for specific purposes. Therefore, such modifications must be made at the discretion of the kit builder according to information which will be much more readily available from some local source.

SHIPPING INSTRUCTIONS

Before returning a unit for service, be sure that all parts are securely mounted. Attach a tag to the instrument giving name, address and trouble experienced. Pack in a rugged container, preferably wood, using at least three inches of shredded newspaper or excelsior on all sides. **DO NOT SHIP IN THE ORIGINAL KIT CARTON AS THIS CARTON IS NOT CONSIDERED ADEQUATE FOR SAFE SHIPMENT OF THE COMPLETED INSTRUMENT.** Ship by prepaid express if possible. Return shipment will be made by express collect. Note that a carrier cannot be held liable for damage in transit if packing, in HIS OPINION, is insufficient.

SPECIFICATIONS

All prices are subject to change without notice. The Heath Company reserves the right to discontinue instruments and to change specifications at any time without incurring any obligation to incorporate new features in instruments previously sold.

WARRANTY

The Heath Company limits its warranty of parts supplied with any kit to a period of three (3) months from the date of purchase. Replacement will be made only when said part is returned postpaid, with prior permission and in the judgment of the Heath Company was defective at the time of sale. This warranty does not extend to any Heathkits which have been subjected to misuse, neglect, accident and improper installation or applications. Material supplied with a kit shall not be considered as defective, even though not in exact accordance with specifications, if it substantially fulfills performance requirements. This warranty is not transferable and applies only to the original purchaser. This warranty is in lieu of all other warranties and the Heath Company neither assumes nor authorizes any other person to assume for them any other liability in connection with the sale of Heathkits.

The assembler is urged to follow the instructions exactly as provided. The Heath Company assumes no responsibility or liability for any damages or injuries sustained in the assembly of the device or in the operation of the completed instrument.

HEATH COMPANY
Benton Harbor, Michigan

PART No.	PARTS Per Kit	DESCRIPTION	PART No.	PARTS Per Kit	DESCRIPTION
Resistors-Control			Tubes-Fuse		
1-1	1	47 Ω 1/2 watt	411-25	2	12AU7 tube
1-6	1	470 Ω 1/2 watt	411-74	2	KT66 tube
1-16	1	4700 Ω 1/2 watt	411-76	1	5R4GY tube
1-21	2	15 K Ω 1/2 watt	421-2	1	3AG fuse
1-22	2	22 K Ω 1/2 watt	Chassis Parts		
1-22	2	22 K Ω 1/2 watt (matched)	90-36	1	Perforated metal cover
1-26	2	100 K Ω 1/2 watt	200-M76F100AB	1	Chassis
1-33	3	470 K Ω 1/2 watt	205-M38	1	Bottom plate
1-42	2	270 Ω 1/2 watt	205-M43F	1	Escutcheon plate
1-44	1	2200 Ω 1/2 watt	206-3	2	Tube shield
1-7A	1	47 K Ω 1 watt	391-2	1	Heathkit nameplate
1-26A	2	15 K Ω 1 watt	Transformers-Choke		
1-28A	6	100 K Ω 1 watt	46-12	1	7h 150 ma filter choke
1-48A	1	4700 Ω 1 watt 5%	51-19	1	Output transformer
1-10B	2	47 K Ω 2 watt (matched)	54-32	1	Power transformer
1-11B	1	22 K Ω 2 watt	Wire-Sleeving		
1-17B	1	6800 Ω 2 watt	89-1	1	Line cord
1-20B	2	100 Ω 2 watt	206-4	1	length Spirashield
2-6A	2	30 Ω 1 watt 1/2%	340-2	1	length #20 bare wire
3-6D	1	100 Ω 4 watt wirewound	340-3	1	length #16 bare wire
3-6G	1	330 Ω 7 watt wirewound	344-1	1	length Hookup wire
11-23	1	300 Ω wirewound control	346-1	1	length Insulated Sleeving
Condensers			Hardware		
20-4	1	270 $\mu\mu\text{f}$ mica	250-2	4	3-48 x 1/4 screw
20-49	1	240 $\mu\mu\text{f}$ mica	250-8	6	#6 sheet metal screw
23-28	1	.1 μfd 200 volt	250-9	31	6-32 x 3/8 screw
23-53	3	.1 μfd 400 volt	250-18	14	8-32 x 3/8 screw
23-66	2	1 μfd 400 volt	250-48	4	6-32 x 1/2 screw
25-10	1	20-20-20 μfd 450 volt elec.	250-52	8	4-40 x 1/4 pan head screw
25-16	2	20 μfd 350 volt elec.	250-53	2	10-24 x 3 1/2 screw
25-28	2	100 μfd 50 volt elec.	252-1	4	3-48 hex nut
25-36	2	40 μfd 450 volt elec.	252-2	8	4-40 hex nut
25-37	1	40-40 μfd 450 volt elec.	252-3	39	6-32 hex nut
Connectors-Insulators-Sockets			252-4	10	8-32 hex nut
73-1	2	3/8" rubber grommet	252-7	1	3/8-32 hex nut
73-2	2	3/4" rubber grommet	252-16	2	Speed nut
423-1	1	Fuse holder, complete	252-17	2	10-24 T-nut
431-1	3	1-dual-lug terminal strip	253-6	2	#10 fiber washer
431-2	1	2-lug terminal strip	253-9	4	#8 flat washer
431-3	1	3-lug terminal strip	253-10	1	Control washer
431-4	3	3-dual-lug terminal strip	254-1	39	#6 lockwasher
431-5	1	4-lug terminal strip	254-2	14	#8 lockwasher
431-14	2	2-lug terminal strip	254-4	1	3/8 ID control lockwasher
431-18	1	2-contact meter jack	254-7	4	#3 lockwasher
431-21	1	4-contact terminal block	254-9	8	#4 lockwasher
434-42	1	Phono socket	260-11	4	Spring catch clip
434-20	2	2-prong, 110 volt socket	261-6	4	Rubber feet
434-43	2	9-pin miniature tube socket	262-4	4	Spring catch pin
434-58	4	Octal socket	595-103	1	Instruction manual
438-4	1	Phono plug			
481-3	2	Condenser mounting wafer			

RESISTORS

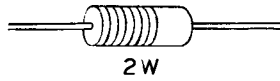
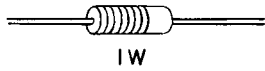
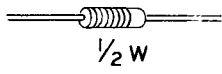

GROMMETS

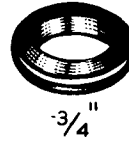

SCREWS



LOCKWASHERS

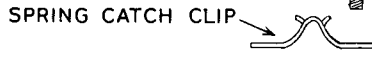
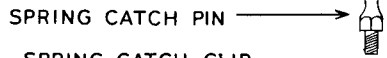
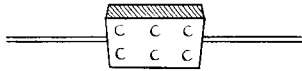

TERMINAL STRIPS

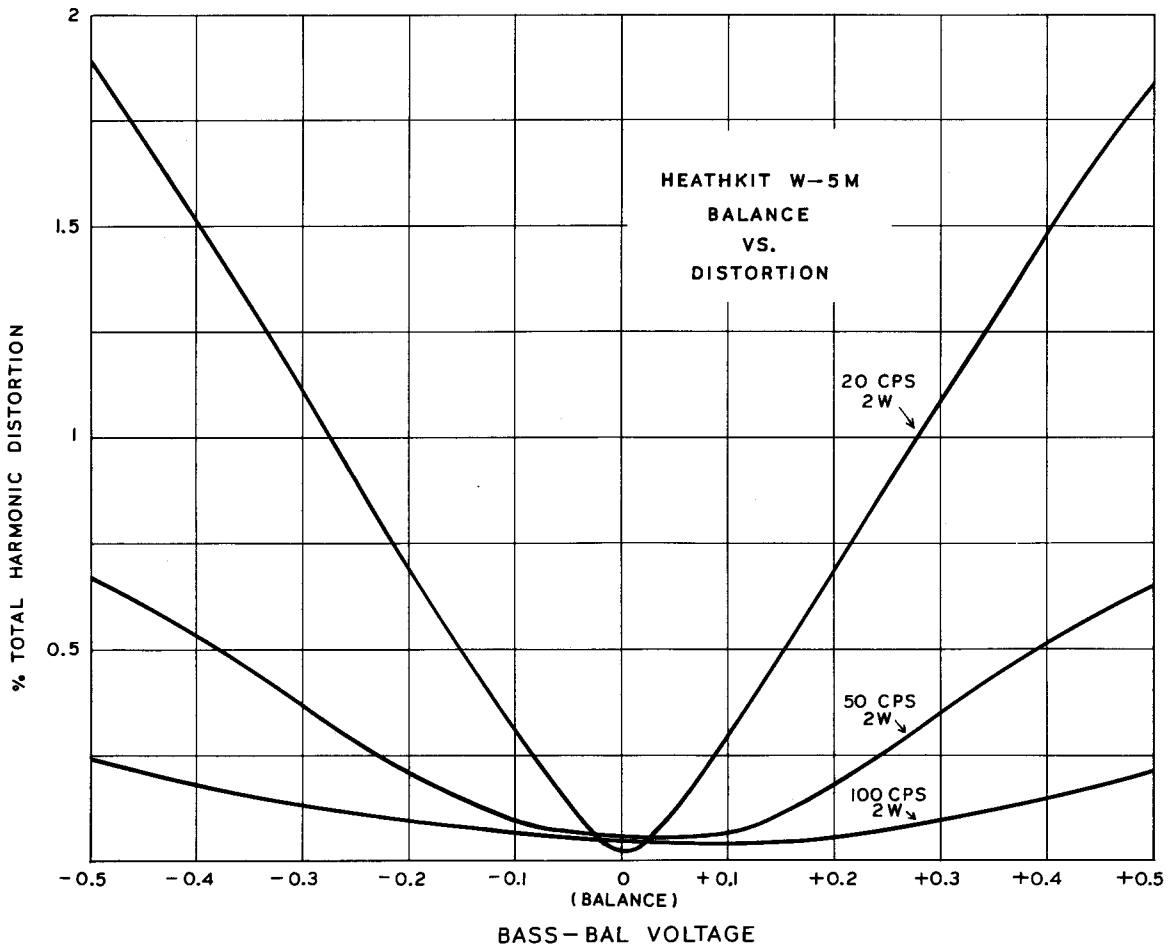
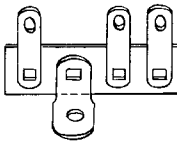
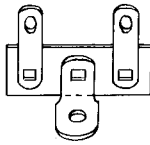
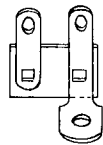
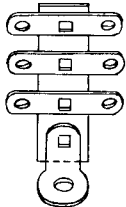

HELPFUL KIT BUILDING INFORMATION

Before attempting actual kit construction read the construction manual through thoroughly to familiarize yourself with the general procedure. Note the relative location of pictorials and pictorial inserts in respect to the progress of the assembly procedure outlined.

This information is offered primarily for the convenience of novice kit builders and will be of definite assistance to those lacking thorough knowledge of good construction practices. Even the advanced electronics enthusiast may benefit by a brief review of this material before proceeding with kit construction. In the majority of cases, failure to observe basic instruction fundamentals is responsible for inability to obtain desired level of performance.

RECOMMENDED TOOLS

The successful construction of Heathkits does not require the use of specialized equipment and only basic tools are required. A good quality electric soldering iron is essential. The preferred size would be a 100 watt iron with a small tip. The use of long nose pliers and diagonal or side cutting pliers is recommended. A small screw driver will prove adequate and several additional assorted screw drivers will be helpful. Be sure to obtain a good supply of rosin core type radio solder. Never use separate fluxes, paste or acid solder in electronic work.

ASSEMBLY

In the actual mechanical assembly of components to the chassis and panel, it is important that the procedure shown in the manual be carefully followed. Make sure that tube sockets are properly mounted in respect to keyway or pin numbering location. The same applies to transformer mountings so that the correct transformer color coded wires will be available at the proper chassis opening.

Make it a standard practice to use lock washers under all 6-32 and 8-32 nuts. The only exception being in the use of solder lugs—the necessary locking feature is already incorporated in the design of the solder lugs. A control lock washer should always be used between the control and the chassis to prevent undesirable rotation in the panel. To improve instrument appearance and to prevent possible panel marring use a control flat nickel washer under each control nut.

When installing binding posts that require the use of fiber insulating washers, it is good practice to slip the shoulder washer over the binding post mounting stud before installing the mounting stud in the panel hole provided. Next, install a flat fiber washer and a solder lug under the mounting nut. Be sure that the shoulder washer is properly centered in the panel to prevent possible shorting of the binding post.

WIRING

When following wiring procedure make the leads as short and direct as possible. In filament wiring requiring the use of a twisted pair of wires allow sufficient slack in the wiring that will permit the twisted pair to be pushed against the chassis as closely as possible thereby affording relative isolation from adjacent parts and wiring.

When removing insulation from the end of hookup wire, it is seldom necessary to expose more than a quarter inch of the wire. Excessive insulation removal may cause a short circuit condition in respect to nearby wiring or terminals. In some instances, transformer leads of solid copper will have a brown baked enamel coating. After the transformer leads have been trimmed to a suitable length, it is necessary to scrape the enamel coating in order to expose the bright copper wire before making a terminal or soldered connection.

In mounting parts such as resistors or condensers, trim off all excess lead lengths so that the parts may be installed in a direct point-to-point manner. When necessary use spaghetti or insulated sleeving over exposed wires that might short to nearby wiring.

It is urgently recommended that the wiring dress and parts layout as shown in the construction manual be faithfully followed. In every instance, the desirability of this arrangement was carefully determined through the construction of a series of laboratory models.

SOLDERING

Much of the performance of the kit instrument, particularly in respect to accuracy and stability, depends upon the degree of workmanship used in making soldered connections. Proper soldered connections are not at all difficult to make but it would be advisable to observe a few precautions. First of all before a connection is to be soldered, the connection itself should be clean and mechanically strong. Do not depend on solder alone to hold a connection together. The tip of the soldering iron should be bright, clean and free of excess solder. Use enough heat to thoroughly flow the solder smoothly into the joint. Avoid excessive use of solder and do not allow a flux flooding condition to occur which could conceivably cause a leakage path between adjacent terminals on switch assemblies and tube sockets. This is particularly important in instruments such as the VTVM, oscilloscope and generator kits. Excessive heat will also burn or damage the insulating material used in the manufacture of switch assemblies. Be sure to use only good quality rosin core radio type solder.

Antenna General		Resistor General		Neon Bulb		Receptacle two-conductor	
Loop		Resistor Tapped		Illuminating Lamp		Battery	
Ground		Resistor Variable		Switch Single pole Single throw		Fuse	
Inductor General		Potentiometer		Switch double pole single throw		Piezoelectric Crystal	
Air core Transformer General		Thermistor		Switch Triple pole Double throw		1000 =	K
Adjustable Powdered Iron Core		Jack two conductor		Switch Multipoint or Rotary		1,000,000 =	M
Magnetic Core Variable Coupling		Jack three conductor		Speaker		OHM =	Ω
Iron Core Transformer		Wires connected		Rectifier		Microfarad =	MF
Capacitor General		Wires Crossing but not connected		Microphone		Micro Microfarad =	MMF
Capacitor Electrolytic		A. Ammeter V. Voltmeter		Typical tube symbol Plate suppressor Grid cathode filament screen		Binding post	
Capacitor Variable		G. Galvanometer MA. Milliammeter uA. Microammeter, etc.				Terminal strip	

HEATH COMPANY
BENTON HARBOR, MICHIGAN

THE WORLD'S
Finest
TEST EQUIPMENT
IN KIT FORM