

OCTOBER

Radio-Electronics

TELEVISION • SERVICING • HIGH FIDELITY

HUGO GERNSBACK, Editor-in-chief

Safety Valve for Sensitive Meters

Adapters for Tube Testers

New Solid-State I.F. Transformers

Troubleshooting With Color Bar Generator

Transistor Stereo Preamp and Control Center

See page 4

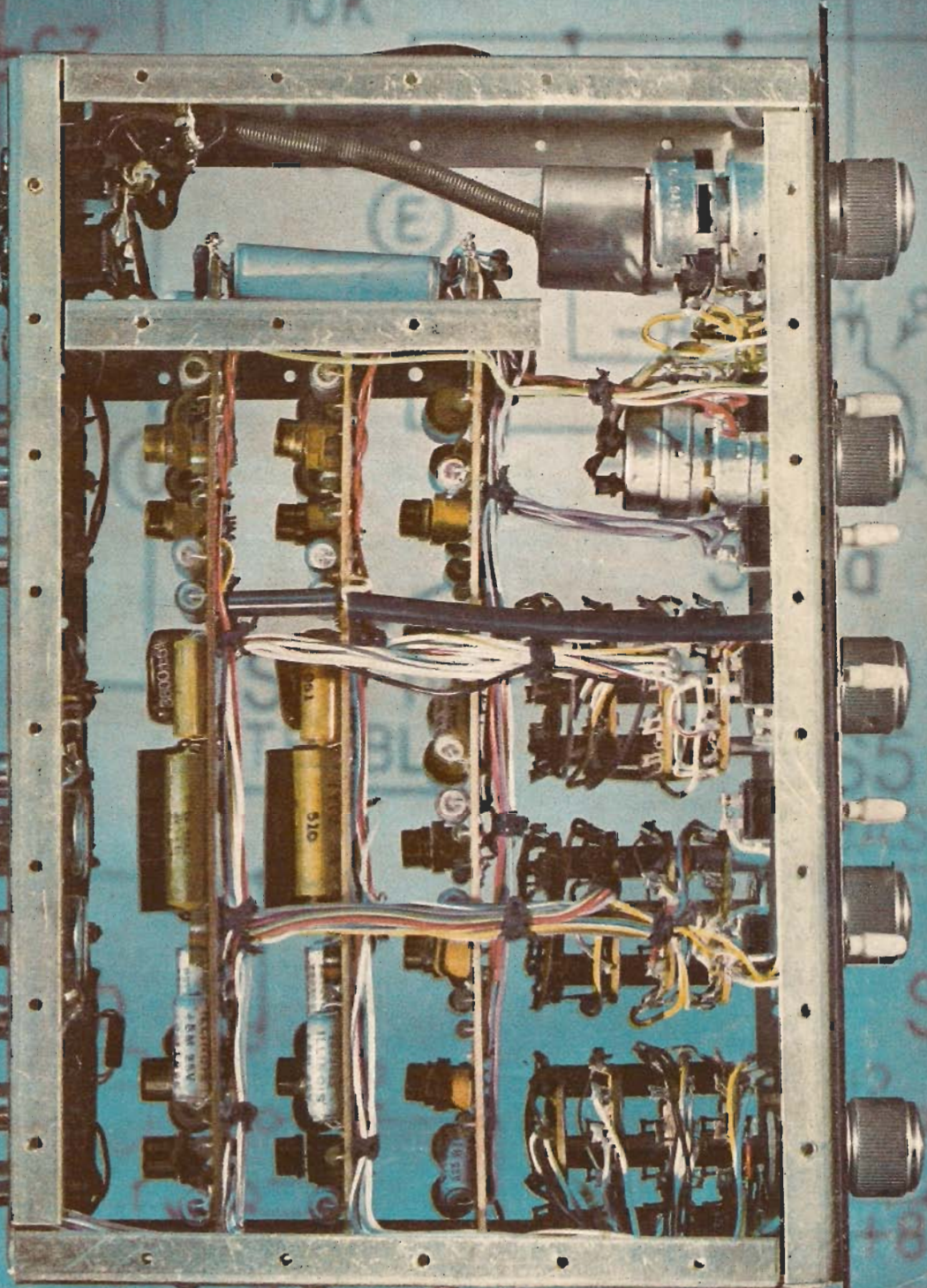

50c

STEREO PREAMP

**COVER
STORY**

By
**DANIEL
MEYER***



Has EVERYTHING

Including all-transistor circuit, step bass and treble controls, optional phase reversal, compact printed circuits, professional quality, and moderate cost

SPECIFICATIONS

- Power:** 12 volts dc, 15 ma
- Frequency response:** Flat $\pm 1/2$ db 20–20,000 cycles; down 1 db at 10 and 50,000 cycles
- Gain:** Measured at 1,000 cycles with volume control set to maximum and balance control at 50% of rotation position
- Phono:** 8-mv input for 1.0-volt output; maximum input 40-mv
- Tape:** 4-mv input for 1.0-volt output
- Mike:** 8-mv input for 1.0-volt output
- FM:** Variable with level controls from 0.8-volt input for 1.0-volt output
- AM:** 10-mv input for 1.0-volt output
- Auxiliary:** 0.4-volt input for 1.0-volt output
- Tone controls:** ± 12 db at 50 and 10,000 cycles; 4-db steps switch-selected
- Loudness compensation:** Continuously variable from 0 to -30 db contour
- Rumble filter:** 3 db down at 50 cycles; 20 db down at 20 cycles
- Scratch filter:** 3 db down at 7 kc; 20 db down at 20 kc
- Noise:** At least 60 db below 1.0-volt output at any input (measured with inputs shorted)
- Maximum output:** Approximately 1.5 volt rms
- Channel separation:** 45 db at 1 kc
- Output impedance:** Less than 1,000 ohms at any output and under any possible control setting
- Distortion:** Less than 1% second- or third-harmonic distortion 20–20,000 cycles at output level of 1.0-volt rms
- Gain vs temperature:** $+1$ db at 120°F, over gain at 70°F
- Gain vs voltage:** 0 db reference to 12-volt supply
 -1.1 db with 10-volt supply
 $+1.1$ db with 15-volt supply

This preamp was designed as a professional-quality unit that can be custom-built from standard, readily available parts. It may be monaural or stereo and with as many additions to the basic tone controls as you desire. Most parts are mounted on etched-circuit boards for ease of assembly and compactness. The

preamp and tone control sections of each channel are mounted on one board and the extra features—scratch and rumble filters, phase reversal and loudness control—are mounted on a third board that may be omitted if desired. The specification sheet shows the type of performance to expect.

This is definitely not a project to undertake if you have never built a piece of electronic equipment before, but any-

* Research Engineer, Southwest Research Institute, San Antonio, Texas.

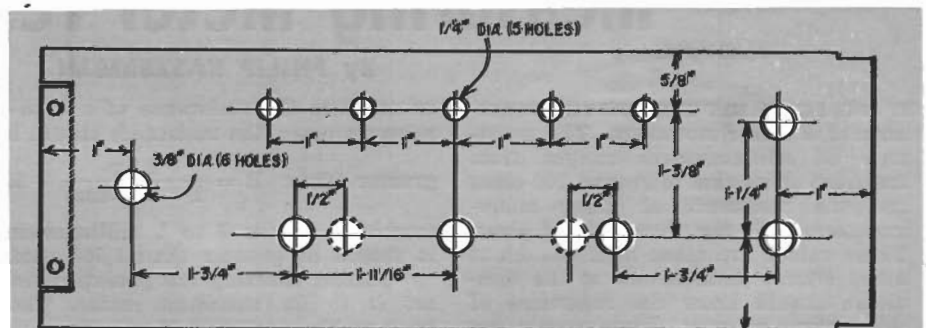

Fig. 1—Template for drilling the front panel.

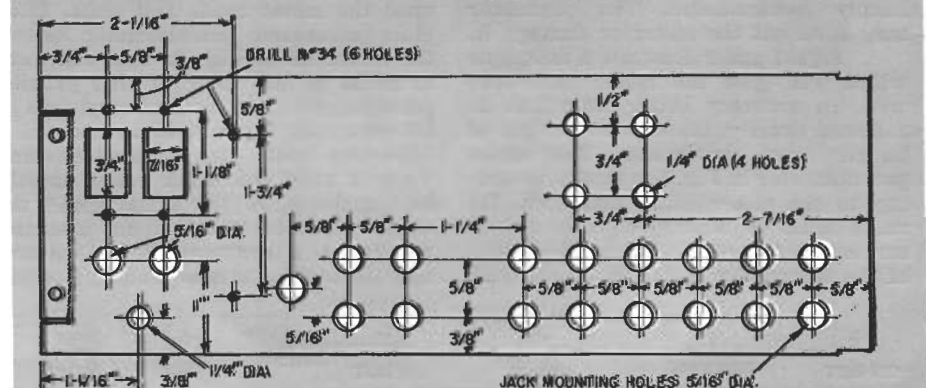

Fig. 2—Drilling template for the rear panel.

one who has assembled a kit or two, or is familiar enough with electronics to read a schematic, should be able to complete the construction successfully. This preamp is not inexpensive. The cost should be between \$100 and \$125, depending on how many features you include in your unit. Any other preamp with similar features will cost as much (probably more) and, if a vacuum-tube type, will be twice as large.

Start by drilling or punching the holes in the chassis panels. Figs. 1, 2, and 3 show location of the various holes. Notice that the templates are for a stereo preamp with all optional features. If you do not intend to include everything, leave out the holes not needed. If you omit the loudness control, position the tone control holes as indicated by dotted circles on the front panel drawing (Fig. 1). If the filters are omitted, only the second and fourth switch holes are needed. If a monaural version is planned, the balance control is not needed and the volume-control hole should be drilled symmetrically with the selector-switch hole on the other end of the panel.

Prepare the drilled rear panel for marking before any parts are mounted.

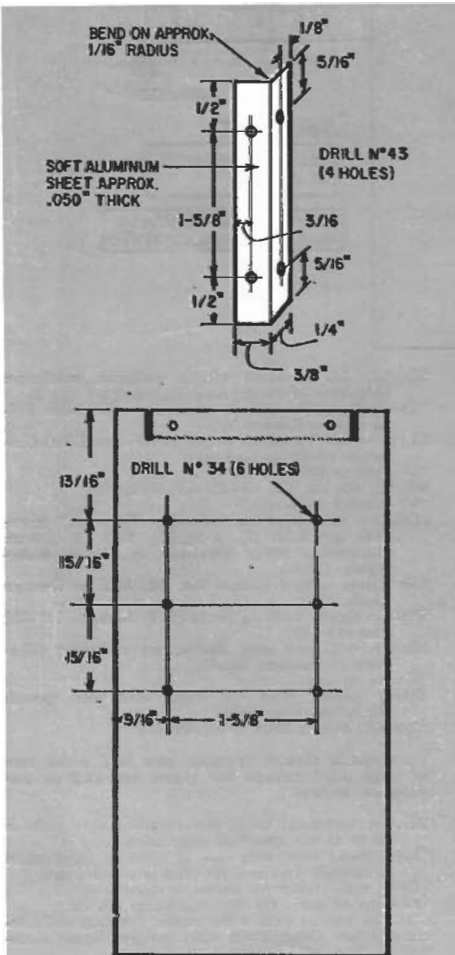
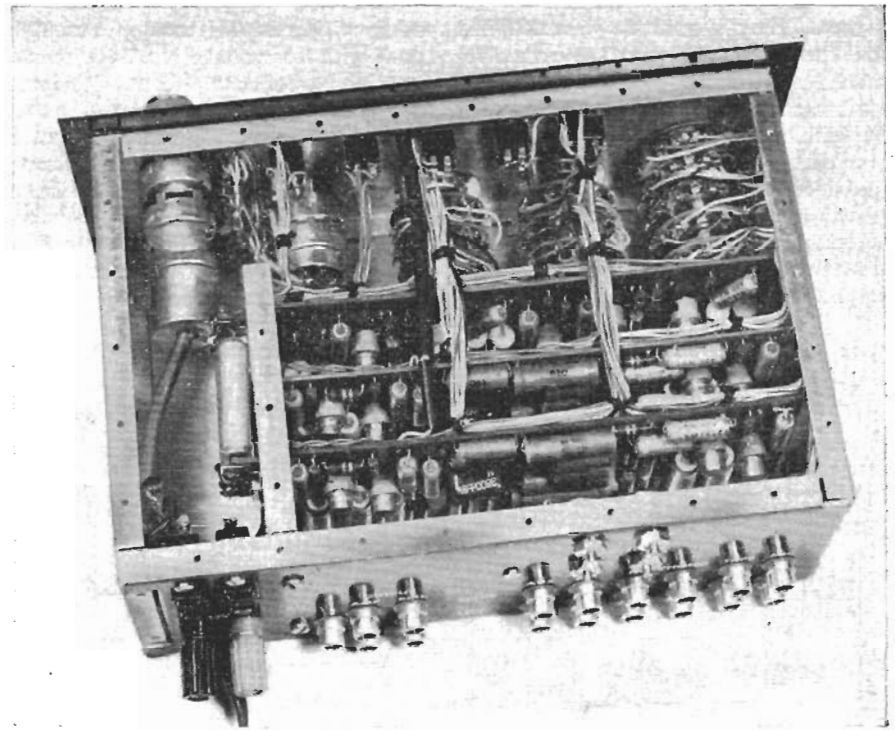
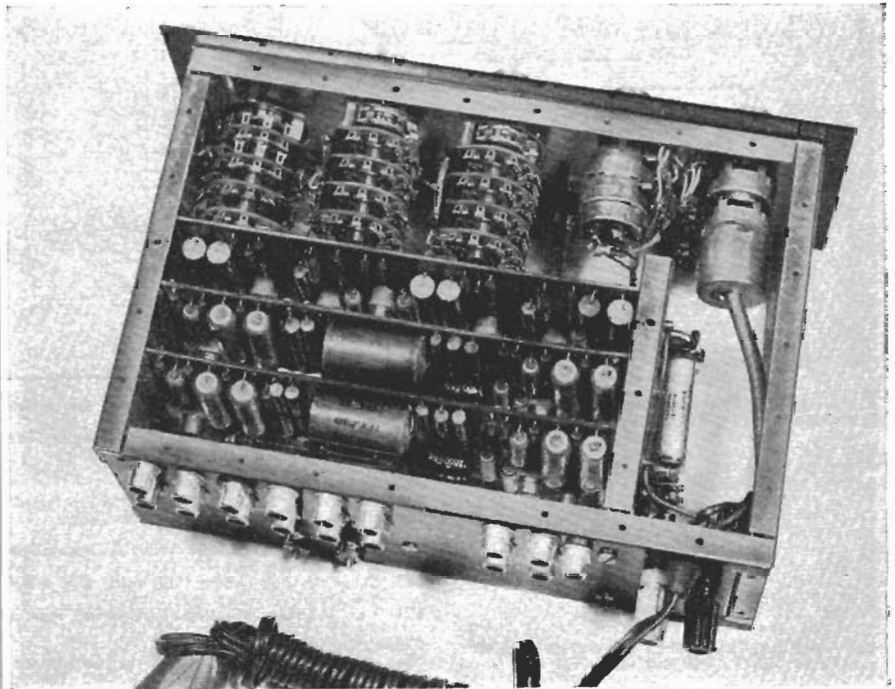

Fig. 3—How to make circuit-board mounting brackets and right side of pre-amp case. Left side of case is undrilled See-Zak R-36.



Top view (above) shows details of wiring and parts placement. Underside (below) is very similar to top view.



Cover the panel with a piece of Scotchcal® the same size as the panel. This is a vinyl plastic with pressure-sensitive adhesive on the reverse side, available at most display advertising businesses.

If a marked front panel like that shown on the original unit is wanted, punch a piece of aluminum sheet stock with the same hole pattern used on the chassis front and cover the punched sheet with Scotchcal. Markings on the front and rear are decals. After these are in place, give the whole surface a

light coat of clear plastic spray to seal the decals to the plastic. The front is held in place by the nuts on the controls. Washers should be used between the nuts and the plastic surface to prevent pulling or tearing. The knobs may be of any available type, or can be selected to match the knobs on other equipment.

Assembling the preamp

Mount the parts on the front and back panels as shown in the photos. Tone-Control switches S4 and S5 must be modified slightly before they are in-

*Trademark of Minnesota Mining & Manufacturing.

stalled. They should be disassembled and the spacers between the wafers replaced with 1/4 inch long spacers. Selector switch S1 should be assembled with 1/4 inch spacers instead of the spacers supplied with the index assembly. All jacks on the back panel except the phono input jack are mounted with insulating washers. The back panel may now be wired and the resistors shown in the photograph installed.

If a center-channel output is used, wire it as shown in Fig. 4. This and all

other wiring in this preamp should be done with low voltage No. 24 wire such as Alpha type 1688. If anything larger is used, the various bundles will get too large to handle easily and may not fit in the available space. It is also helpful if several colors of wire are used. I used about 15 different color-coded wires. This will make it much easier to identify the various wires in the bundles.

In wiring the back panel, run a separate lead from each jack grounding lug to the ground lug on the phono

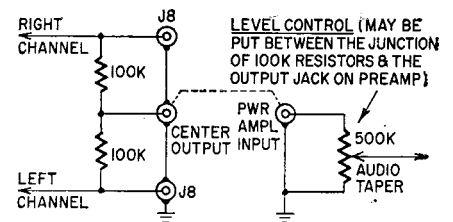
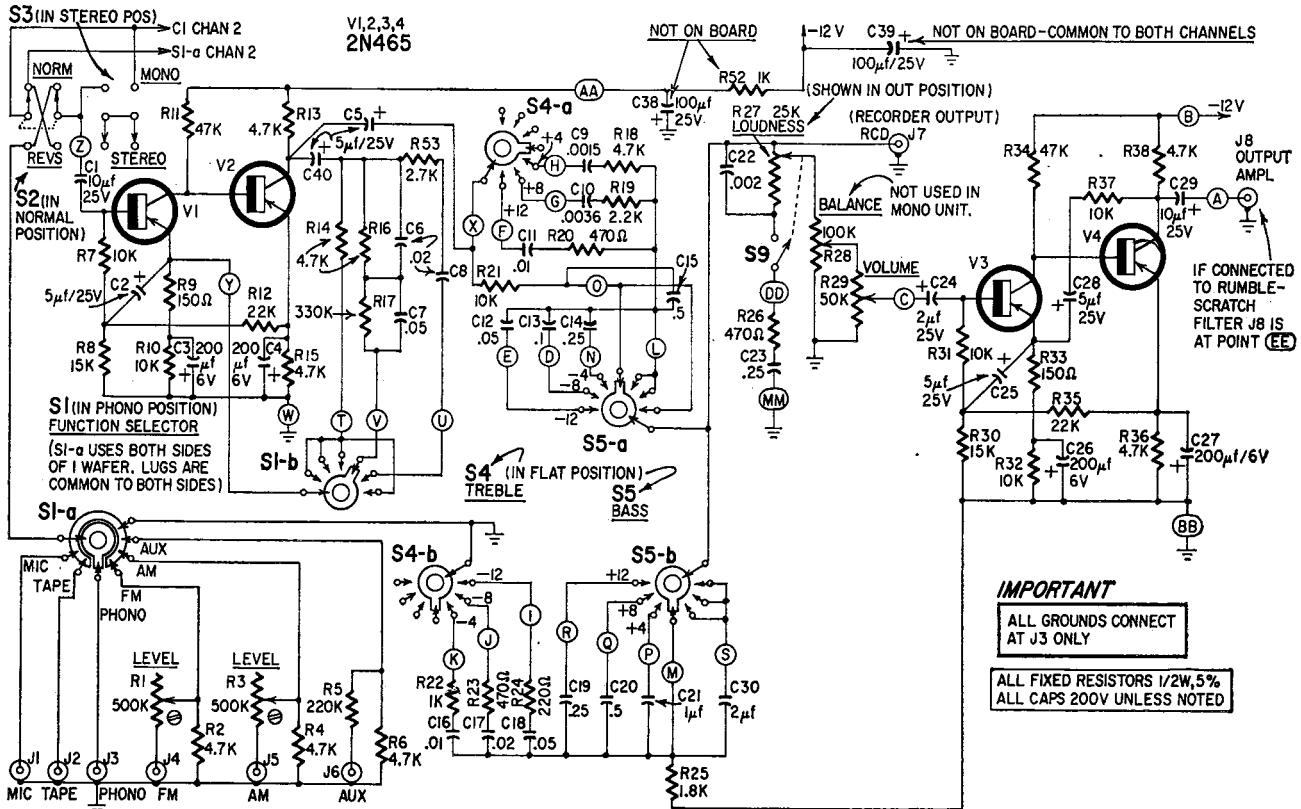

Fig. 4—Wiring for optional center channel output.

jack. Make all other ground connections in the preamp to this point to prevent



- R1, R3—pot, 500,000 ohms, linear, Centralab type JL
- R2, R4, R6, R13, R14, R15, R16, R18, R36, R38—4,700 ohms
- R5—220,000 ohms
- R7, R10, R21, R31, R32, R37—10,000 ohms
- R8, R30—15,000 ohms
- R9, R33—150 ohms
- R11, R34—47,000 ohms
- R12—22,000 ohms
- R17—330,000 ohms
- R19, R43, R47—2,200 ohms
- R20, R23, R26—470 ohms
- R22—1,000 ohms
- R24, R42—220 ohms
- R25—1,800 ohms
- *R27—dual pot, 25,000 ohms per section with spst switch, IRC Q11-120, M11-120, 76-2
- *R28—dual pot, 100,000 ohms per section, IRC SK-1, B17-128, M13-128
- *R29—dual pot, 50,000 ohms per section, IRC K-5, KS-2, B13-123
- R35—22,000 ohms
- R39—1,500 ohms
- R40, R41—33,000 ohms
- R44—100 ohms
- R45, R46—3,900 ohms
- *R48—33,000 ohms
- *R49—15,000 ohms
- *R50, R51—1,000 ohms
- †R52—1,000 ohms
- All fixed resistors 1/2-watt 5%
- C1, C29, C36—10 μ f, 25 volts, electrolytic, subminiature (Illinois type SMT or Sprague TE 1204 or equivalent)
- C2, C5, C25, C28—5 μ f, 25 volts, electrolytic, subminiature (Illinois type SMT or Sprague TE 1212 or equivalent)
- C3, C4, C26, C27—200 μ f, 6 volts, electrolytic, subminiature (Illinois type SMT or Sprague TE 1104 or equivalent)

- C6, C8, C17, C34—.02 μ f, 200 volts, 5%, mylar; Tex-Cap type 25
- C7, C12, C18—.05 μ f, 200 volts, 5%, Mylar; Tex-Cap type 25
- C9—.0015 μ f, 5%; Arco DM-19-362J
- C10—.0036 μ f, 5%; Arco DM-19-362J
- C11, C16—.01 μ f, 200 volts, Mylar; Tex-Cap type 25
- C13—.01 μ f, 200 volts, 5%, metallized Mylar; Tex-Cap type 31
- C14, C19, C23—.025 μ f, 200 volts, 5%, metallized Mylar; Tex-Cap type 31
- C15, C20, C31, C32—.05 μ f, 200 volts, 5%, metallized Mylar; Tex-Cap type 31
- C21—1 μ f, 200 volts, 5%, metallized Mylar; Tex-Cap type 31
- C22—.002 μ f, ceramic, 10%
- C24, C33—2 μ f, 25 volts, electrolytic, subminiature (Illinois type SMT or Sprague TE 1204 or equivalent)
- C30—2 μ f, 200 volts, 5%, metallized Mylar; Tex-Cap type 31
- C35—.002 μ f, 200 volts, 5%, Mylar; Tex-Cap type 25
- *C37—10 μ f, 25 volts, electrolytic, subminiature (Illinois type SMT or Sprague TE 1204 or equivalent)
- †C38—100 μ f, 25 volts, electrolytic subminiature (Illinois type SMT or Sprague TE 1211 or equivalent)
- †C39—100 μ f, 25 volts, electrolytic, subminiature (Illinois type SMT or Sprague TE 1211 or equivalent)
- †C40—5 μ f, 25 volts, electrolytic, subminiature (Illinois type SMT or Sprague TE)
- J1 through J8—phono jacks (Switchcraft 3501FP with S-2207 and S-1564 insulating washers)
- ‡S1—6-position rotary switch; assembled from Centralab PA-300 index (1), PA-30 1-pole 11-position shorting switch section (2), and PA-40 1-pole 11-position all unused contacts shorted (2)

- S2, S3, S6, S7—dpdt toggle switches, miniature Lafayette SF-76 or Alco Electronics
- *S8—dpdt toggle switch, miniature (Lafayette SW-76 or Alco Electronics)
- S4, S5—4-pol 7-position rotary switch (modified Centralab PA-1014) (see text)
- †S9—spst on R27
- V1, V2, V3, V4, V5, V6—2N465 (Motorola)
- *V7—2N465 (Motorola)
- †Chassis—Built from the following "See-Zak" parts: R-39 (2); R-36 (2); R-34 (1); P-69 (2) (Rimac Electronics, 10929 Vanowen St., North Hollywood, Calif.)
- †Ac mains outlets (Alden No. 402-ACE or Herman Smith 1229)
- †Power supply binding posts (E. F. Johnson 111-102 and 111-103)
- †Spacers—1/4 inch long (for rotary switches) (Birnback or Herman Smith)
- †Knobs, to suit
- †Black plastic film for front and rear panels (Scotchcal type 3655)
- †Decals (Walsco 2105 or equivalent)

To build a stereo preamp you will need two of each part except for those marked as explained below.

#For a monaural unit, use single-section pots in place of the specified dual units.
 *In a stereo unit, only one of each of these parts is needed; they are not used in a mono set.
 †Only one of each for stereo or mono unit.
 ‡Number of parts for stereo preamp shown.
 If you cannot obtain the Mylar Tex-Cap units locally, Texas Capacitors, 4301 Langley Road, Houston 16, Tex., will supply them direct.
 Though not our usual policy, we have specified particular makes of components. Equivalents can be used only if they are exactly the same size as the specified units.

Complete circuit of the basic stereo preamp. Only one channel is shown. Move J8 to point EE on noise-filter schematic when filters are used.

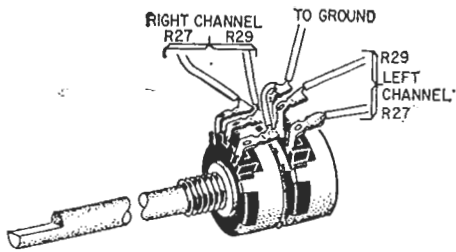
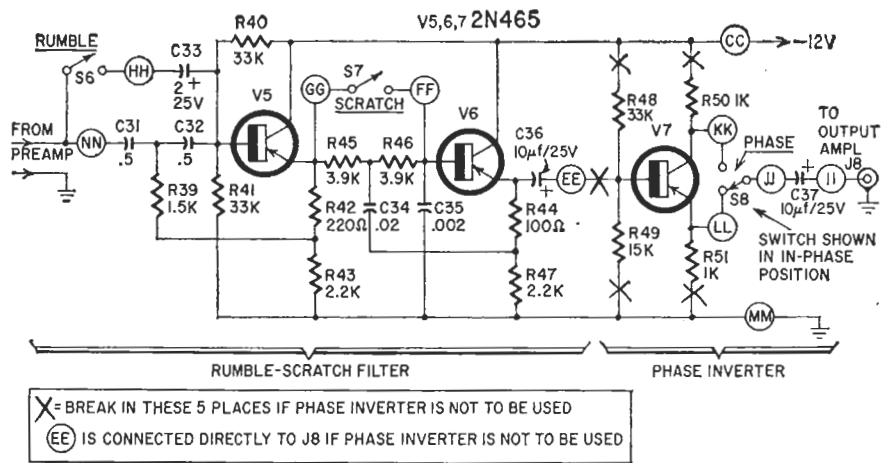

Fig. 5—Balance control wiring.

hum loops. After wiring the panel, pull the wires that go to the selector switch together into a bundle and tie them in several places. Be sure to leave these wires long enough to reach the selector switch on the front panel.

The printed-circuit boards are made from patterns shown, or undrilled circuit boards may be purchased already etched. Mount parts on printed-circuit boards as shown in the diagram. The transistors in the original unit were mounted in sockets, but may be soldered in place if preferred.

After all components are soldered on the boards, solder the wires to the power supply and the various switches to the boards. The wires go into the boards on the back or copper side. Eyelets were used in the wire holes on the original unit to insure a solid contact and reduce the chances of pulling a piece of the copper pattern off the board if a wire were pulled too hard. Cut the wires to the length necessary to reach the points they will connect to. Bring together the wires going to each switch and tie them as shown in the photographs. The wires that connect the VOLUME, BALANCE and LOUDNESS controls and the wiring between the REVERSING and STEREO-MONO switches should be put in as indicated on the schematic. The BALANCE control is wired as shown in Fig. 5. The preamp is now



Circuit for the scratch and rumble filters and phase reversal stage. Parts list is combined with that for the main unit.

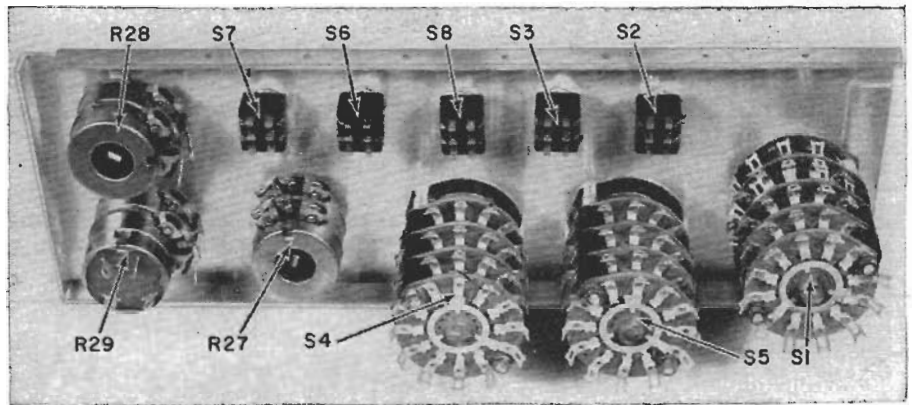

Parts placement on the front panel.

ready for assembly.

Fasten the mounting brackets to the ends of the printed-circuit boards with 4-40 x 1/4-inch sheet-metal screws. Adjust these brackets in the slots on the ends of the boards so that all boards (with brackets on) are the same length. Now screw the right-side panel and the divider panel to the brackets with the

same type screws. Place a terminal strip to mount C38 under the top screw used to hold the front and rear boards on the divider panel. The left-side panel has a terminal strip mounted near the rear of the panel that is used as a tie point for the ac connections. The front, rear and side panels are now assembled by pushing together their interlocking

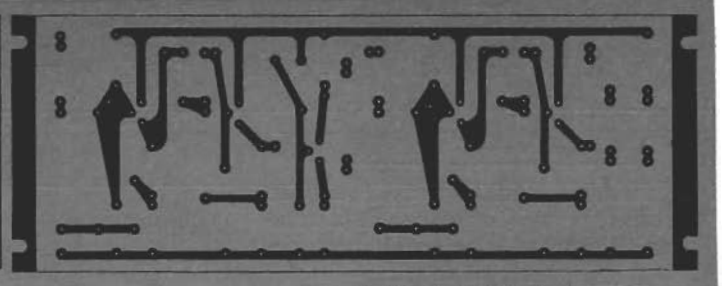
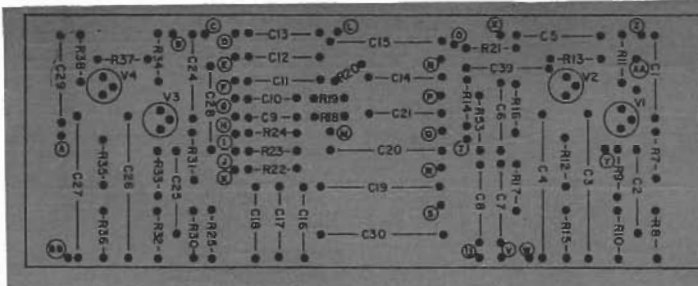

Top (left) and bottom (right) views of printed circuit board for stereo preamp. It is shown half actual size.

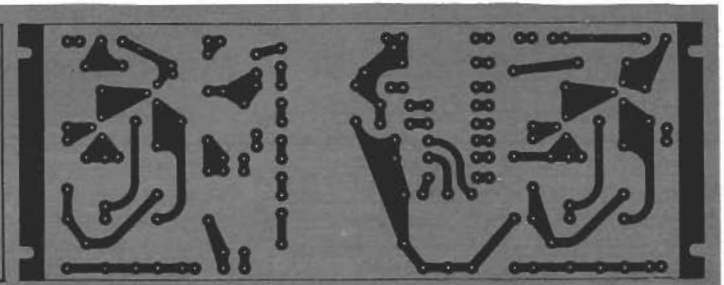
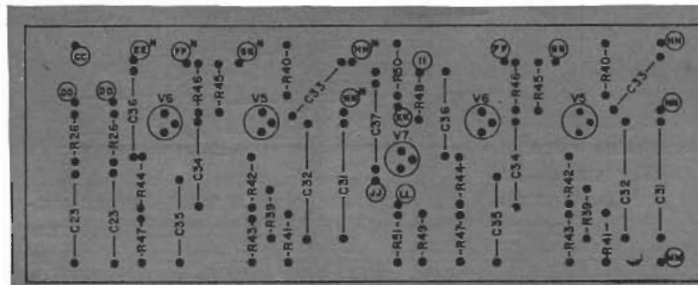

* INDICATES CONNECTIONS TO SECOND CHANNEL AMPLIFIER (THIS CHANNEL DOES NOT INCLUDE PHASE INVERTER)

Top (left) and bottom (right) views of printed board for phase inverter and tone controls (half actual size).

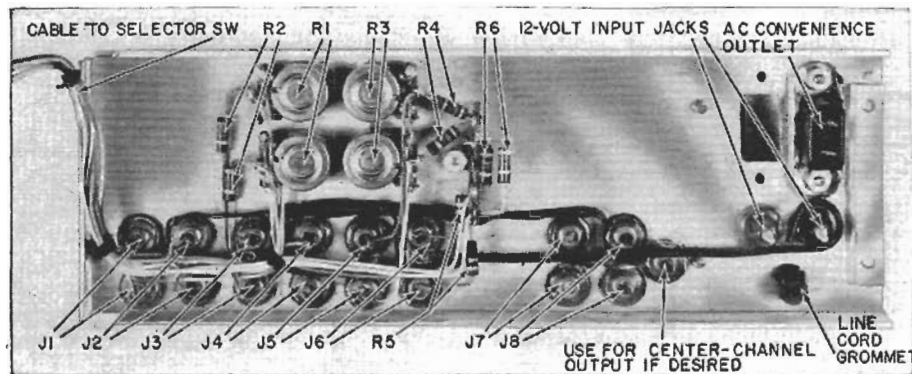

Parts placement on the rear panel.

Transistor	Emitter	Base	Collector
V1	1.4	1.6	4.2
V2	4	4.2	7
V3	1.4	1.6	4.2
V4	4	4.2	7
V5	5.4	5.6	12
V6	5.2	5.4	12
V7	3.2	3.4	8.5

All voltages negative with respect to chassis

edges. Fasten the divider panel to the back panel with two sheet-metal screws.

The on-off switch on the volume control is a dpdt unit. One set of contacts controls the 12 volts to the preamp. The other controls 117 volts to the accessory outlets. This enables you to turn on your power amplifier when you turn on the preamp.

The ac wiring to the switch is run through a piece of spring stock from the terminal strip on the left panel to

PRINTED CIRCUIT BOARDS

Labeled, undrilled printed-circuit boards for this preamp can be obtained from the author—Daniel E. Meyer, 430 Redcliff Drive, San Antonio 16, Tex. The cost is \$1.50 per board. To build a stereo preamp, you will need three boards—two preamp boards and one tone-control phase-inverter board.

the rear of the volume control. The shield over the switch is a Centralab KR-5. The remaining wiring can now be done. Remember to return all ground wires from the boards and switches to the phono input. *Do not connect any wires to the chassis at any other point.*

In this article we have presented complete construction data. Next month we will describe an optional ac supply for the preamp along with a picture of how the circuit operates. **END**

STEREO PREAMP



By
**DANIEL
MEYER***

Has EVERYTHING

Part II — Features and specs of this unusual all-transistor unit

LAST MONTH WE SHOWED YOU HOW TO build a superior hi-fi stereo preamp. Now let's take a closer look at the unit and how it operates.

The preamp is built around two high-gain direct-coupled amplifiers (see schematic in the October issue). Dc feedback from the second transistor's emitter to the first transistor's base insures temperature stability, while ac feedback taken from the second-stage collector to the first-stage emitter gives the input impedance needed and helps reduce distortion. By switching suitable R-C networks into the ac feedback loop, we get the compensation needed for the magnetic phono and tape inputs. In all other positions, the preamp response is flat.

The high-level inputs have attenuators and all signals are fed to V1's base by the selector switch. This simplifies input switching considerably and has no noticeable effect on either the distortion or noise. The selector switch shorts all unused inputs so there will be no chance of cross-talk even if other inputs are not turned off. The AUX input jack does not have a level control, but

* Research engineer, Southwest Research Institute, San Antonio, Texas.

one could be added. If used, it would be connected in the same way as the level controls for the AM and FM inputs. *Do not attempt to improve on the input attenuator circuit by wiring the level controls as potentiometers instead of rheostats as shown.* If this is done, the noise level will depend on the setting of the control and will quickly become excessive as the control is advanced to increase amplification.

The amplifier circuit has a gain of approximately 50 db with the ac feedback loop disconnected. The high open-loop gain also leaves approximately 6 to 8 db of negative feedback still in the circuit at frequencies below 50 cycles. This holds down distortion and insures that phono and tape compensation will be correct and not fall off at low frequencies. Fig. 1 shows the measured deviation from the standard RIAA curve on each channel. The phono compensation was designed to be correct when V1 and V2 have a beta range of 50 to 90. The betas of the transistors in the rest of the circuit are not critical and any transistor of the type specified should be satisfactory. The input impedance in the phono position is approximately 100,000 ohms. If your

cartridge requires a lower terminating resistance for proper high-frequency response, connect a resistor across the phono input jack to bring the input resistance down to the correct value. The shunt resistor value needed for various input resistances is shown in the table.

The various feedback networks are switched by a second wafer on the input selector switch. The switch specified can have as many as ten positions so more inputs than the six shown may be added. Monaural operation and channel reversing are switched in or out with two toggle switches between the input selector and V1's base. Either or both may be omitted. Slide switches are usually used for this type of switching, but toggle switches are easier to mount, more reliable, and also look better.

Tone controls

The preamp output feeds a step type passive tone-control network. Such a system is usually found in only the most expensive equipment because of the increased number of parts and the additional wiring. This type of tone control has a number of advantages. First, you can be certain that the response is flat when the control is

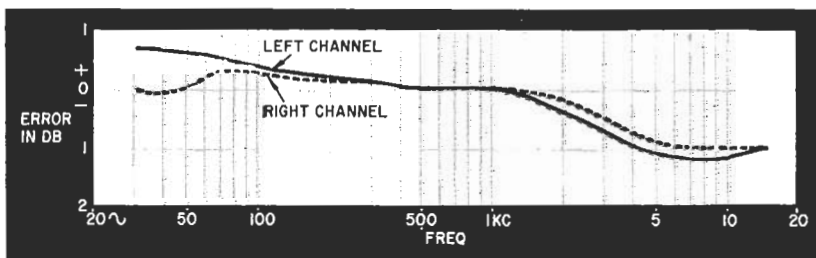

Fig. 1—Measured deviation from standard RIAA curve.

Cartridge Terminating Resistance needed	Resistance to be added across input
100K	none
47K	47K
27K	39K

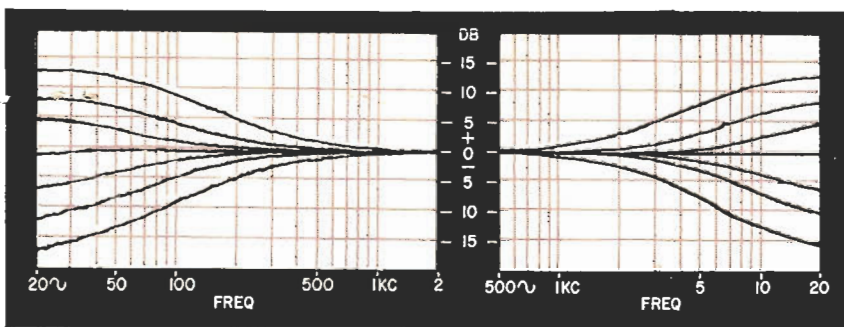

Fig. 2 (left)—Bass tone control response. Fig. 3 (right)—Treble tone control response.

switched to the flat or zero compensation position. Second, you can be certain of the exact amount of compensation being used and can reset this amount exactly. Each step on these controls provides approximately a 4-db change at 50 cycles for the BASS control and at 10,000 cycles for the TREBLE control. A smaller change could hardly be noticed, so no one should miss the fact that settings between these steps are not possible.

The curves in Figs. 2 and 3 show the range of compensation available with these tone controls. Notice that the controls are of the variable-turnover type rather than the less desirable but simpler to build variable-slope type. The BASS curves are actually better than they appear. The 1-db drop at the low end was caused by the sweep oscillator used to trace the curves. The symmetry and precision of the tone-control response depend on the component values being correct. For this reason, 5% tolerance parts are used in the tone-control networks.

The tone controls work into the LOUDNESS-BALANCE-VOLUME system. Typical loudness compensation curves are shown in Fig. 4. A switch on the rear of the control removes loudness compensation completely when the control is turned fully counter clockwise. The BALANCE control can reduce the volume on either channel to zero, but causes little loss when set to its mid-range position (3 db). This is due to the use of complementary log tapers on its two sections.

The volume control works into the second amplifier unit. This two-stage amplifier is almost identical to the preamp. It gives the gain needed to provide an output level that will drive a power amplifier. This second amplifier (V4) drives the rumble filter, scratch filter and phase inverter, if they are included in the preamp. The filters have a 12-db-per-octave slope starting at 60 cycles for the rumble filter and 6,000 cycles for the scratch filter.

The fast cutoff rate allows the rumble filter to remove most of the rumble without damaging low-frequency response seriously. In most cases, it would

be hard to tell by listening to the music that this filter was being used. Only on the highest quality speakers, and on music with a great deal of low-frequency sound such as organ music, will the effect of this filter be noticed by many people.

The scratch filter was designed to be used with old or worn records, weak and noisy FM reception, etc. Its effect is not nearly as subtle as that of the rumble filter, but the results are desirable where there is much noise and little or no high-frequency information being received.

Figs. 5 and 6 show the response with the rumble and scratch filters in circuit. The phase-reversal circuit is used on only one channel and introduces a 180° phase shift in it. This control is not absolutely necessary and may be left out, but it can be very handy for checking or correcting speaker phasing. The filters and the phasing circuit have unity gain and low distortion due to the large amounts of degenerative feedback used. They do not affect the gain of the preamp when they are switched into or out of the circuit.

An extra jack is provided on the back panel for a mixed center-channel output if this is desired. A level control for this channel may be installed on the back of the preamp if there is no gain control on the power amplifier used for the center channel. The output at this jack will be R + L, when the PHASE switch is in one position and R - L in the other.

Power supply

The preamp requires 12 volts dc at 15 ma. This may be obtained from other equipment, batteries or an ac supply. For the lowest hum level, use batteries. A pair of 6-volt lantern batteries connected in series will run the preamp for 6 months to a year with an average amount of use. If you prefer an ac supply, use the circuit in Fig. 7.

Testing and use

Connect the power supply and check the preamp for proper operation. If

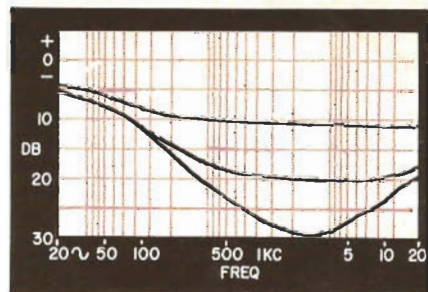

Fig. 4—Typical response of loudness control.

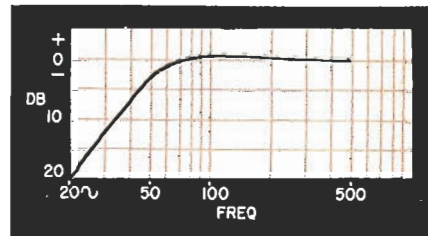

Fig. 5—Response with rumble filter in circuit.

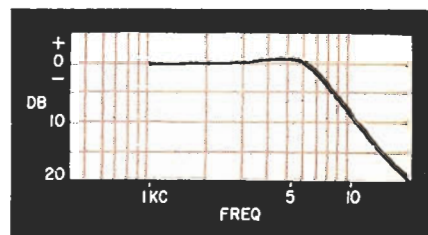

Fig. 6—Response with scratch filter in circuit.

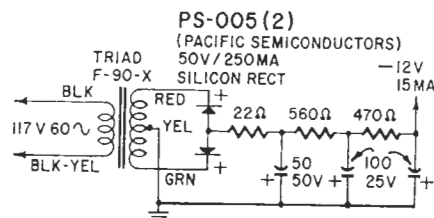
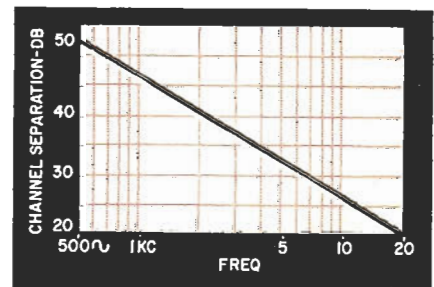
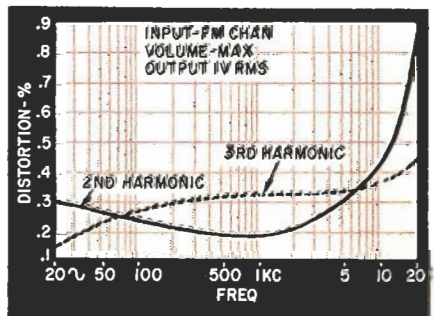

Fig. 7—Ac power supply for the preamp.



Channel separation vs. frequency.



Harmonic distortion vs. frequency.

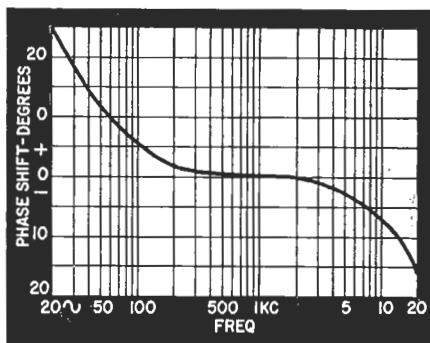

Phase response.

operation is not proper, check the wiring and transistor voltages. See table on page 48 of the October issue. It gives the voltages at the transistors. These should not be taken as exact values, since a 10 to 20% variation could occur due to component tolerances without causing trouble. If this check fails to turn up the trouble try signal tracing with an audio oscillator and detector. This is done by connecting the oscillator to one of the inputs and tracing the signal through the circuits with an oscilloscope, ac voltmeter or head-

The preamp may now be installed in the equipment cabinet. Choose a spot that is not directly over a power amplifier or other component that produces a large amount of heat. The heat will not affect preamp operation, but will dry out the electrolytic capacitors. To keep hum down, it would also be wise to avoid locations near power transformers or turntable motors.

Connect the cables from the sources to be used to the input jacks and from the power amplifiers to the output jacks. Set the level controls to give the same output on AM and FM as in the PHONO position. Connect the amplifiers and speakers so that right- and left-channel outputs are correct with the reversing switch in the NORM position. Speaker phasing can be checked by facing the speakers toward each other, placing them about 4 to 6 inches apart, and playing a record. If throwing the phase switch produces more bass output from the speakers, the phasing is wrong and the wires to one speaker should be reversed. Set the VOLUME control fully clockwise, and the BALANCE control to 50% of rotation. Play a recording and set the level controls on the power amplifiers to produce the highest sound level that will ever be needed. Now turn down the gain on the preamp and check the speakers for equal output. If one is lower, turn the gain on that power amplifier up slightly until both speakers have equal output.

You should be ready now to make that most enjoyable of all tests called a listening test. Put on one of your favorite records, settle down in a good listening spot between the speakers and enjoy the music.

END