

Audio Amplifiers Utilizing: SPiKe™ Protection

National Semiconductor
Application Note 898
John DeCelles



INTRODUCTION

As technology develops, integrated circuits continue to provide an advantage to consumers requiring products with more functionality and reliability for their money. It's been less than fifty years since the first transistor began to provide audio amplification to consumers. Technology changed, bringing to the market higher power discretes and hybrids with the later development of lower powered monolithics. Today with the development of IC technologies, high-performance monolithic audio amplifiers arrive, allowing consumers to experience high-power, high-fidelity audio systems in compact packages.

The **Overture™** Audio Power Amplifier Series possesses a unique protection system that saves audio amplifier designers components, size, and cost of their systems. This translates into higher-power, more functional, more reliable, compact audio amplification systems.

These advantages, generally provided only in high-end discrete amplifiers, are accomplished by providing a protection mechanism within a monolithic power package. Since audio amplifier designers generally need to provide some sort of protection to the output transistors in order to keep product failures to a minimum, National Semiconductor's Audio Group has designed SPiKe (Self Peak Instantaneous Temperature ("Ke)) Protection. This is a protection mechanism designed to safeguard the amplifier's output from overvoltages, undervoltages, shorts to ground or to the supplies, thermal runaway, and instantaneous temperature peaks.

The following pages will explain in detail each of the protections provided by SPiKe protected audio amplifiers, the advantages they bring to audio designers, and why they are necessary.

Each of the protection sections on the following pages will refer to *Figure 1*. (Amplifier Equivalent Schematic with Simplified SPiKe Protection Circuitry) when its functionality is described.

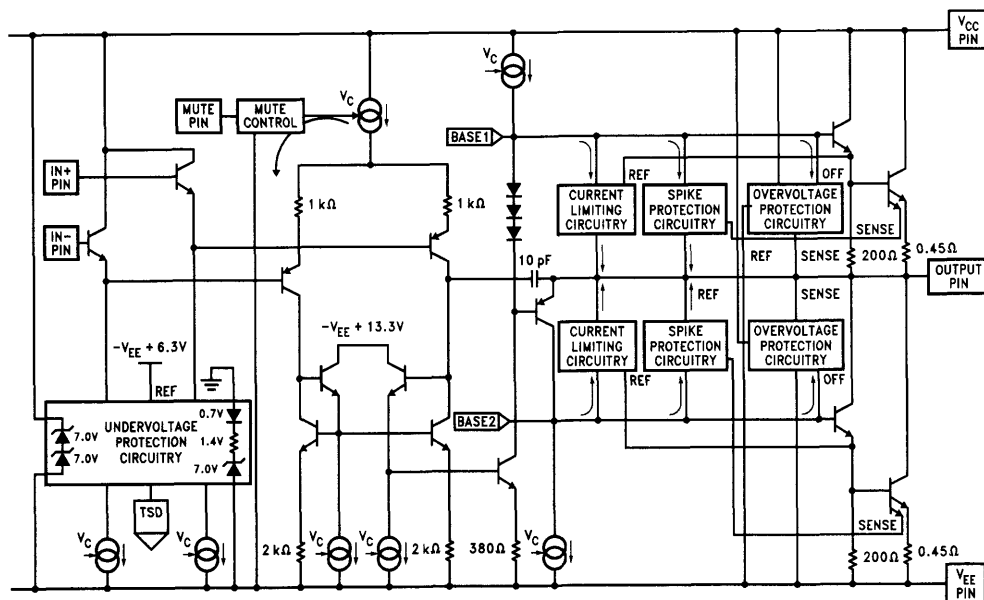

FIGURE 1. Amplifier Equivalent Schematic with Simplified SPiKe Protection Circuitry

TL/H/11869-1

SELF PEAK INSTANTANEOUS TEMPERATURE LIMITING (SPIKe)

SPIKe Protection is a "uniquely-smart" protection mechanism that will adjust its output drive capability according to its output operating conditions, thus safeguarding itself against the most stringent power limiting conditions.

Other power amplifiers on the market provide SOA protection by calculating external resistances for adjustable current limiting whose primary function is to keep the amplifier within its safe operating area. Not only do these amplifiers require external components, but they also have a design conflict between fault protection and maximum output current drive capability. In order to keep the device from self-destructing against output shorts to either supply rail, the adjustable current limit must be significantly lowered, thus limiting the device's current drive capability.

SPIKe protected audio amplifiers provide extensive fault protection without sacrificing output current drive capability. Its circuitry functions by sensing the output transistor's temperature, enabling itself when the temperature reaches approximately 250°C. Depending upon the amplifier's present operating conditions, the device will reduce the output drive transistor's base current, as shown in Figure 1, keeping the transistor within its safe operating area.

The uniqueness of SPIKe protected audio amplifiers is its ability to monitor the output drive transistor's safe operating area dynamically, regardless of an output to ground short, an output to supply short, or the reaching of its power limit by any pulse within the audio spectrum.

As can be seen from Figures 2a-c, the safe operating area is reduced for all pulse widths as the case temperature increases. This indicates that good heatsinking is required for optimal operation of the power amplifier. Figures 3a-c illustrate the reduction of the safe operating area by the increasing effect of enabling SPIKe Protection on a 100 Hz sine wave due to increasing case temperatures.

As seen in the Current Limiting section, a short to ground with an input pulse applied to the amplifier will be current limited by the conventional current limiting circuitry for a few hundred microseconds. When the junction temperature reaches its limit, SPIKe protection takes over, limiting the output current further, as the junction temperature tries to rise above 250°C.

This protection scheme results in the power capabilities being dependent upon the case temperature, the transistor operating voltages, V_{CE} , and the power dissipation versus time.

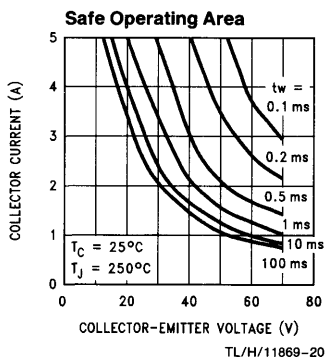

FIGURE 2a. $T_C = 25^\circ\text{C}$

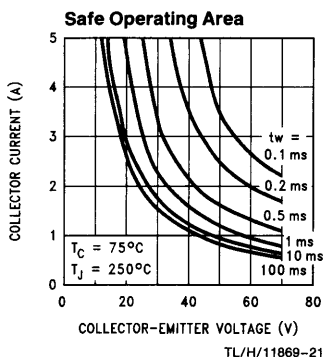

FIGURE 2b. $T_C = 75^\circ\text{C}$

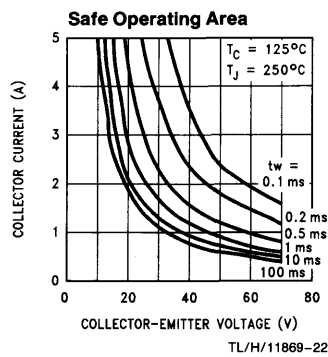

FIGURE 2c. $T_C = 125^\circ\text{C}$

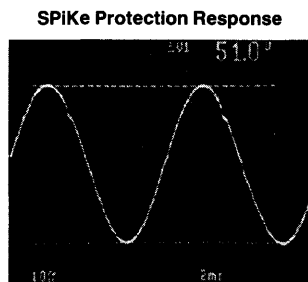

FIGURE 3a. $T_C = 75^\circ\text{C}$

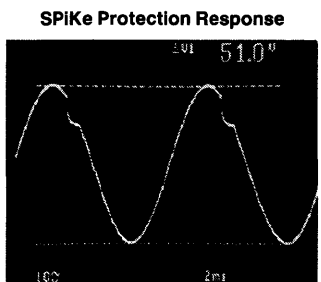

FIGURE 3b. $T_C = 80^\circ\text{C}$

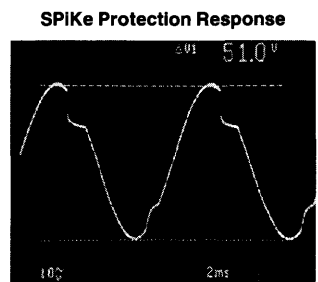
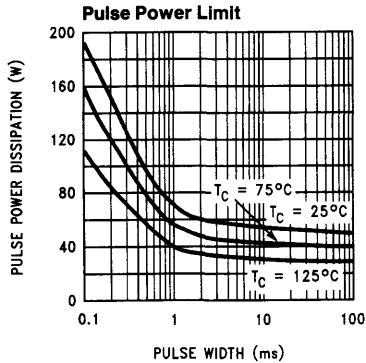

FIGURE 3c. $T_C = 85^\circ\text{C}$

Figures 4 and 5 are provided for each SPiKe Protected audio power amplifier and should be used to determine the power transistor's peak dissipation capabilities and the power required to activate the power limit. This information may help a designer to determine the maximum amount of power that SPiKe protected amplifiers may deliver into different loads before enabling SPiKe protection.

Figure 4 shows the peak power dissipation capabilities of the output drive transistor at increasing case temperatures for various output pulse widths.

Figure 5 shows the power required to activate SPiKe circuitry at increasing case temperatures over the operating voltage range.



TL/H/11869-26

FIGURE 4. Pulse Power Dissipation vs Pulse Width

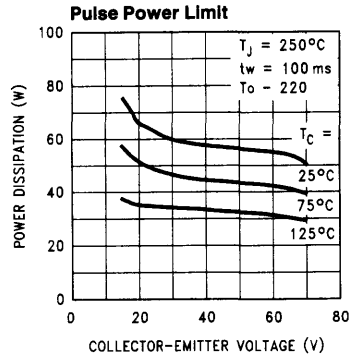

TL/H/11869-27

FIGURE 5. Pulse Power Dissipation vs V_{CE}

OVERVOLTAGE—OUTPUT VOLTAGE CLAMPING

One of the most important protection schemes of an audio amplifier is the protection of the output drive transistors against large voltage flyback spikes. These spikes are created by the sudden attempt to change the current flow in an inductive load, such as a speaker. When a push-pull amplifier goes into power limit (i.e., reaching the SOA limit) while driving an inductive load, the current present in the inductor drives the output beyond the supplies. This large voltage spike may exceed the breakdown voltage rating of a typical audio amplifier and destroy the output drive transistor. In general, the amplifier should not be stressed beyond its *Absolute Maximum* (No Signal) Voltage Supply Rating and should be protected against any condition that may lead to this type of voltage stress level. This type of protection generally requires the use of costly zener or fast recovery Schottky diodes from the output of the device to each supply rail.

However, SPiKe protected audio amplifiers possess a unique overvoltage protection scheme that allows the device to sustain overvoltages for nominally rated speaker loads. Referring to *Figure 1*, the protection mechanism functions by first sensing that the output has exceeded the supply rail, then immediately turns the driving output transistor off so that its breakdown voltage is not exceeded. The circuitry continues to monitor the output, waiting to turn the output drive transistor back on when the overvoltage fault has ceased.

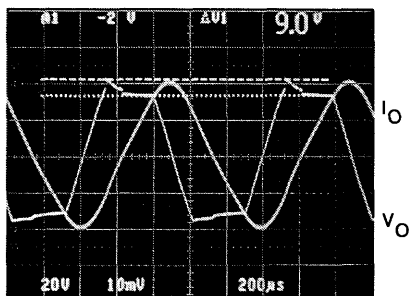

FIGURE 6a. Positive Output Voltage Clamping Waveform

TL/H/11869-2

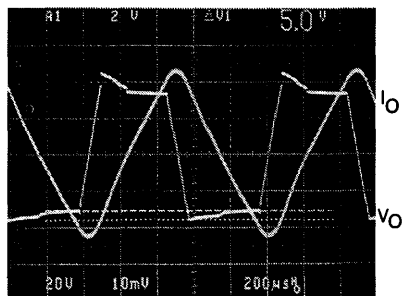

FIGURE 6b. Negative Output Voltage Clamping Waveform

TL/H/11869-4

While monitoring the output, the IC also provides SPiKe protection if needed. Finally, SPiKe protected audio amplifiers possess an internal supply-clamping mechanism; a zener plus a diode drop from the output to the positive supply rail and an intrinsic diode drop from the output to the negative rail. This equates to clamping of approximately 8V on the positive rail and 0.8V on the negative rail as can be seen in *Figures 6a* and *6b*, respectively.

Figures 7a and *7b* model the output stage for each overvoltage condition exemplifying how the voltage waveforms are clamped to their respective values for high frequency waveforms. As shown in the Self Peak Instantaneous Temperature Limiting (SPiKe) section, *Figures 2a-c*, the safe operating area for lower frequency waveforms is much smaller than for higher frequency waveforms. Therefore, the power limits of low frequency waveforms may be reached much more easily than for high frequency waveforms. It is due to this fact that more extreme and more frequent overvoltages may occur at lower frequencies, as shown in *Figures 8-11*. The peak output voltage spikes may increase beyond the described clamping values due to extreme power conditions, however, the waveforms will decrease to the clamping values with the discharge of the output inductor current, as shown in *Figure 8*.

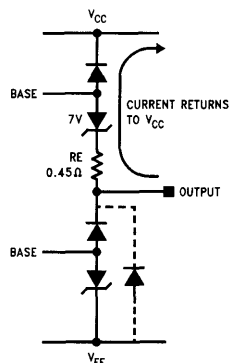

FIGURE 7a. Output Stage Overvoltage Model (V_{CC})

TL/H/11869-3

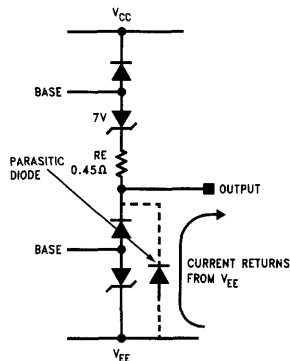

FIGURE 7b. Output Stage Overvoltage Model ($-V_{EE}$)

TL/H/11869-5

The lower output stage has the advantage of an intrinsic diode from the negative rail to the output which can replace the usual external clamping diode in an audio amplifier. This intrinsic diode is an advantage of the monolithic IC, capable of handling the large current flowing through the load at the time of the power limit.

The system is not protected against all reactive loads since these clamping diodes will dissipate large amounts of power that cannot be controlled by the peak temperature limiting circuitry if the fault is sustained for a long period of time. It should also be noted that for purely reactive loads, all of the power is dissipated in the amplifier and none in the load. This implies that if the load is more reactive than resistive, at those frequencies, more power will be dissipated in the amplifier than delivered to the speaker. Since the impedance characteristics of a speaker change over frequency, it is very important to know what types of loads the amplifier can and cannot drive in order to not only match the amplifier and speaker for optimum performance, but also to protect the amplifier from trying to outperform itself. It is the mismatching of components or low dips in the resistive component of a complex speaker that can cause an amplifier to go into power limit. The likelihood of reaching the amplifier's power limit is greatly reduced when the minimum impedance that the amplifier can drive is known.

Figures 8–11 are examples of the LM3876 reaching its power limit, experiencing large flyback voltages from an inductive load, for various input signals and loads.

The test conditions for Figures 8–11 are as follows:

- Using an LM3876
- No external compensation components
- $V_{CC} = \pm 35V$
- $A_{VCL} = 20$
- $I_O/Div. = 2.0A/div$
- $Z_L = 7.5\text{ mH} + 4\Omega$ for Figure 8
- $Z_L = 7.5\text{ mH} + 2\Omega$ for Figures 9–11
- $f = 100\text{ Hz}$ for Figures 8, 9, and 11
- $f = 70\text{ Hz}$ for Figure 10

In Figure 8, the 4.5Vpk input signal applied to the amplifier with a closed-loop gain of 20, produces the severely clipped 34V output voltage waveform, as shown. The sharp 48.5V overvoltage spike that occurs at the crossover point is due

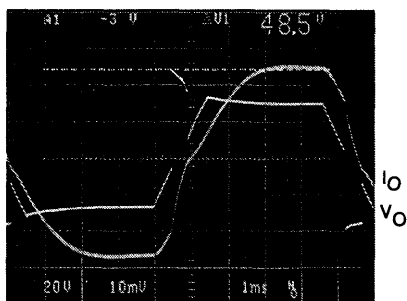

TL/H/11869-6

FIGURE 8. Overvoltage Exceeding Clamping Level

to the amplifier output stage reaching the SOA (Safe Operating Area) limit. For this waveform, the collector-emitter voltage is quite large, while the output current is also quite large (4A). Referring to Figures 2a–c, it is easily understood that the SOA power limit has been reached.

When the SOA limit is reached, the SPiKe protection circuitry tries to limit the output current while the inductor tries to continuously supply the current it has stored. Since the current in an inductor can't change instantaneously, the current is driven back into the output up through the upper drive transistor, as shown in Figure 7a.

It is this current that causes the large flyback voltage spike on the output waveform. The peak of the voltage spike can be found by taking the current going through the output at the time of the power limit multiplied by the 0.45Ω emitter resistor and adding it to the zener-diode combination. In Figure 6a this would be $(2A)(0.45\Omega) + 8V$ which is approximately 9V, as shown by the cursors. For the lower output stage, the clamping voltage is controlled by an intrinsic diode that replaces costly output clamping diodes.

In Figure 8, when the current reaches close to zero, the voltage at the output tends to move towards the output voltage that it would have been if the power limit had not been reached. This is typical for all overvoltage occurrences. It should be noted that when the overvoltage fault occurs, the device is no longer functioning in the closed-loop mode.

In Figure 9, one waveform is actually a sinewave with SPiKe protection enabled, as in Figures 3a–c, with the same overvoltage spikes as in Figure 8 and the other waveform is the output current. In the middle of the response, the current is rising toward 6A when SPiKe is enabled, causing a "bite" to be taken out of the sinewave. The device is just trying to limit the output current at this point, as explained in the SPiKe Protection section. The overvoltage flyback spike then occurs while the output current discharges to zero. However, this time when the current reaches zero, the current and voltage must make up for what it had lost and try to return to its position on the amplified input waveform. The voltage jumps up to its value, but the current must slowly and continuously charge up to its place on the current waveform, then continue downward as the lower output stage starts sinking current. It must be remembered that the current waveform would have been a sinewave if the SOA power limit hadn't been reached.

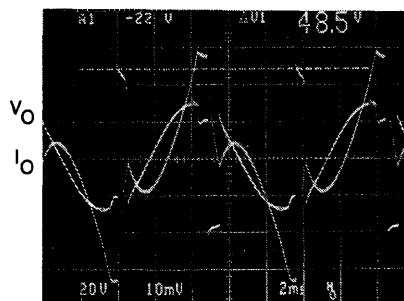

TL/H/11869-7

FIGURE 9. Reaching the SOA Power Limit, $f = 100\text{ Hz}$, SPiKe Enabled

Multiple SOA power limits on the output waveform are the difference between *Figures 9 and 10*. *Figure 10* is intended to show that multiple SOA power limits can occur under extreme loading conditions. The amplifier is trying to drive a 70 Hz sinewave into a 7.5 mH inductor in series with a 2Ω resistor. As the signal frequency decreases, with a low resistance load, the number of SOA power limits will increase. The frequency of reaching power limits will depend upon the size of the reactance as the load.

Figure 11 is intended to exemplify the large current overdrive that can occur when the output waveform is driven hard into the rails. Notice that the current is over 6Apk for each voltage swing.

It must be remembered that it is the large voltage across the output drive transistors that would normally exceed a discrete output transistor's breakdown voltage. A discrete power transistor that is not protected with output clamping diodes would be destroyed if its breakdown voltage was exceeded. SPiKe protected audio amplifiers clearly show the ability to withstand overvoltages created by low impedance loads.

The integration of output overvoltage protection within monolithic audio amplifiers provides the advantage of eliminating expensive fast-recovery Schottky diodes that would be used in a discrete design, thus resulting in fewer external components and a lower system cost.

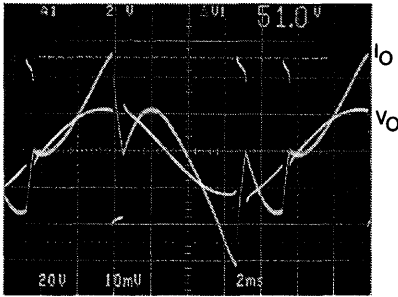

TL/H/11869-8

FIGURE 10. Multiple SOA Power Limits

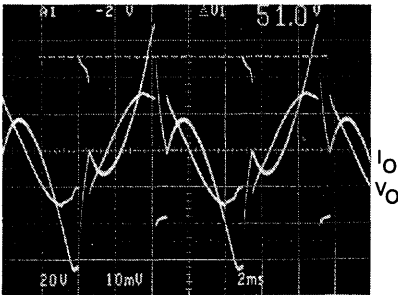

TL/H/11869-9

FIGURE 11. Output Saturation Causing Extreme Overvoltage

UNDERVOLTAGE—POPLESS POWER-ON/OFF

SPiKe protected audio amplifiers possess a unique under-voltage protection circuit that eliminates the annoying and destructive pops that occur at the output of many amplifiers during power-up/down. SPiKe's under-voltage protection was designed because all DC voltage shifts or "pops" at the output should be avoided in any audio amplifier design, due to their destructive capability on a speaker. These pops are generally a result of the unstable nature of the output as internal biasing is established while the power supplies are coming up.

SPiKe Protection accomplishes this by disabling the output, placing it in a high impedance state, while its biasing is established. This function is achieved through the disabling of all current sources within the device as denoted by control signal V_C , in *Figure 7*. For the LM2876, LM3876, and LM3886, the control signal will not allow the current sources to function until 1) the total supply voltage, from the positive rail to the negative rail, is greater than 14V and 2) the negative voltage rail exceeds $-9V$. The LM3875 is under-voltage protected with the relative 14V total supply voltage condition only. Thus for the "6"-series, the amplifiers will not amplify audio signals until both of these conditions are met. It is this $-9V$ protection that causes the under-voltage protection scheme to disable the output up to 18V between the positive and negative rail, assuming that both supply rails come up simultaneously. This can be seen in *Figure 12a*. The $-9V$ under-voltage protection is ground referenced to eliminate the possibility of large voltage spikes, that occur on the supplies, which may enable the relative 14V under-voltage protection momentarily.

It should be noted that the isolation from the input to the output, when the output is in its high-impedance state, is dependent upon the interaction of external components and traces on the circuit board.

As can be seen in *Figures 12a and 12b*, the transition from ground to $\pm V_{CC}$ and from $\pm V_{CC}$ to ground upon power-on/off is smooth and free of "pops". It can also be seen from the magnification of *Figure 12a* in *Figure 12c*, that the amplifier doesn't start amplifying the input signal until the supplies reach $\pm 9V$. It is also evident that there is no feedthrough from 0V to $\pm 9V$. It must be noted that the sinewave being amplified is clipped initially as the supplies are coming up, but after the supplies are at their full values, the output sinewave is actually below the clipping level of the amplifier.

It should also be noted that the waveforms were obtained with the mute pin of the LM3876 sourcing 0.5 mA, its 0 dB attenuation level. If the mute pin is sourcing less than 0.5 mA, the nonlinear attenuation curve may induce cross-over distortion or signal clipping. The Mute Attenuation curves vs. Mute Current in the datasheets of the LM2876, LM3876, and LM3886 show this nonlinear characteristic. The LM3875 is the sister part to the LM3876 and does not have a mute function.

For optimum performance, the mute function should be either enabled or disabled upon power-up/down. Although the undervoltage protection circuitry is not dependent upon the mute pin and its external components, the mute function can be used in conjunction with the undervoltage function to provide a longer turn-on delay. It should be noted that the mute function is also popless. Of the multiple ways to set the mute current and utilize the mute function, the use of a regulator can continuously control the amount of current out of the mute pin. This regulation concept keeps the attenuation level from dropping below 0 dB when the supply is sagging. More information about mute circuit configurations will be provided later in a future application note.

The advantages of undervoltage protection in SPiKe protected audio amplifiers are that no pops occur at the output upon power-up/down. Customers can also be assured that their speakers are protected against DC voltage spikes when the amplifier is turned on or off.

CURRENT LIMITING—OUTPUT SHORT TO GROUND

Whether in the lab or inside a consumer's home, the possibility of an amplifier output short to ground exists. If current limiting is not provided within the amplifier, the output drive

transistors may be damaged. This means one of two things, either sending the unit to customer service for repair or if you're in the lab, throwing the discrete drive transistor or hybrid unit away and replacing it with a new one. SPiKe protected audio amplifiers eliminate this costly, time-consuming hassle by providing current limiting capability internally.

This also means that the multiple components required to provide current limiting capability in a discrete design are eliminated with the monolithic audio amplifier solution, once again, reducing the system size and cost.

The value of the current limit will vary for each particular audio amplifier and its output drive capability. Please refer to each amplifier's datasheet Electrical Characteristics section for particular current limits.

As can be seen in *Figure 13a*, the value of current limiting for the LM3876 is typically 6 Apk when $V_{CC} = \pm 35V$ and $R_L = 1\Omega$. From the scope cursors at the top of the waveform $I_{LIMIT} = V_o/R_L$. This test was performed with a closed-loop gain of 20 and an input signal of 2V ($t_w = 10$ ms).

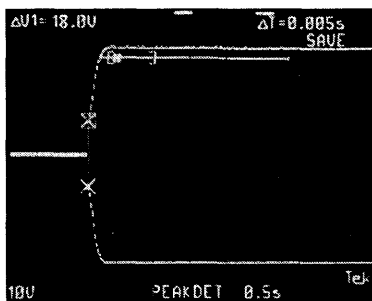

TL/H/11869-10

FIGURE 12a. Output Waveform Resulting from Power-On Undervoltage Protection

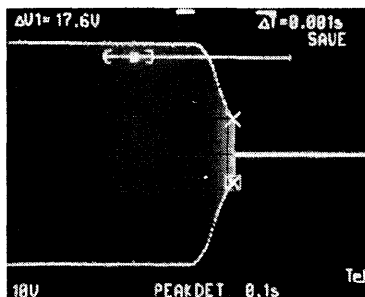

TL/H/11869-11

FIGURE 12b. Output Waveform Resulting from Power-Off Undervoltage Protection

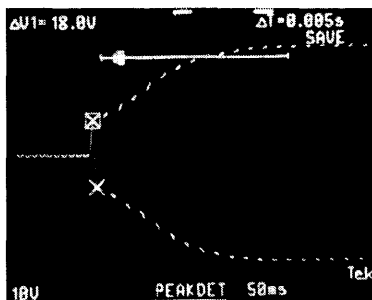

TL/H/11869-12

FIGURE 12c. Output Waveform Resulting from Power-On Undervoltage Protection

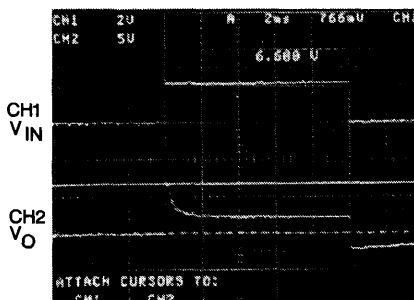

TL/H/11869-13

FIGURE 13a. LM3876 Typical Current Limiting with SPiKe Protection ON

Notice that the initial current limit is at its peak value of approximately 6A, but as time increases, the final current limit decreases. This is due to the enabling of the instantaneous temperature limiting circuitry or SPIKe protection. When the IC is in current limiting, the temperature of the output drive transistor array increases to its limit of 250°C, at which time SPIKe protection is enabled, reducing the amount of output drive current. It is this further reduction of its drive current that prevents the output drive transistor from exceeding the safe operating area.

As shown in *Figures 13b-d*, as the input pulses' time increases, the level of SPIKe protection imposed on the waveform increases. It should be noted that SPIKe protection was enabled after 200 μ s of current limiting in *Figures 13c* and *13d*, but is in general dependent upon the case temperature, the transistor operating current and voltage, and its power dissipation versus time.

The internal current limiting circuitry functions by monitoring the output drive transistor current. The sensing of an increase in this current signals the circuitry to pull away drive current from the base of the output drive transistor as shown in *Figure 1*. The harder the input tries to drive the output, the more current is pulled away from the output drive transistor, thus internally limiting the output current.

Another point worth mentioning is that with increasing supply voltages, the turn-on point of SPIKe protection, when in current limiting, will decrease. Since the internal power dissipation is greater, it will take a shorter amount of time before the temperature of the output drive transistor increases to the SOA limit.

Once again, SPIKe protected audio amplifiers save design time and external component count by integrating system solutions within the IC, translating into more cost reduction.

CURRENT LIMITING—OUTPUT SHORT TO SUPPLY

One feature of SPIKe Protection which can prevent costly mistakes from occurring in the lab when prototyping Overture audio amplifiers is its protection from output shorts to the supply rails. The device is protected from momentary shorts from the output to either supply rail by limiting the current flow through the output transistors.

Although accidents such as this one occur infrequently, accidents do happen and if one were to happen with Overture audio amplifiers they would be protected for a limited amount of time. Normally when an accident like this would occur in a discrete design with no current limiting protection, the output transistor would be subjected to the full output swing plus a large current draw from the supply. This type of stress would destroy an output stage discrete transistor whereas with SPIKe protected amplifiers, the current is internally limited, thus preventing its output transistors from being destroyed.

One note to make about this protection scheme is that the current limitation is not sustained indefinitely. In essence, the output shorts to either supply rail should not be sustained for any period of time greater than a few seconds. Frequent temporary shorts from the output to either supply rail will be protected, however, continued testing of the circuitry in this manner is not guaranteed and is likely to cause degradation to the functionality and long-term reliability of the device.

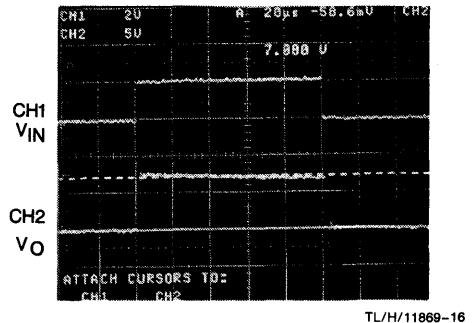

FIGURE 13b. $t_w = 100 \mu$ s, t_{SPIKe} (Not Enabled)

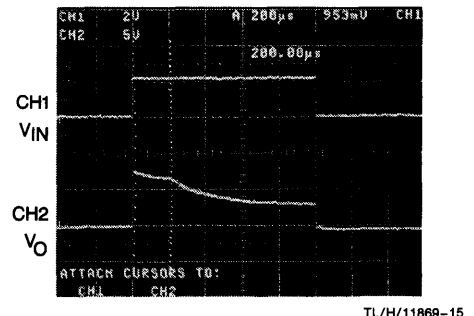

FIGURE 13c. $t_w = 1$ ms, $t_{SPIKe} = 200 \mu$ s

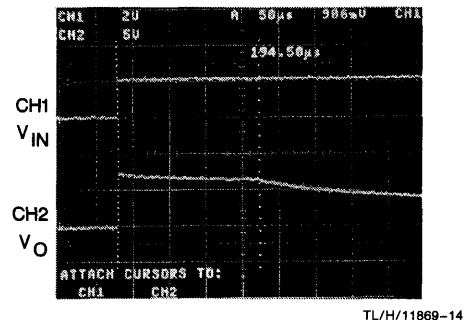

FIGURE 13d. $t_w = 10$ ms, $t_{SPIKe} = 195 \mu$ s

THERMAL SHUTDOWN—Continuous Temperature Rise

An audio system designer's design cycle time is reduced by eliminating the need for designing tricky thermal matching between discrete output transistors and their biasing counterparts which are physically located some distance from each other. Complex thermal sensing and control circuitry provided from the legendary Bob Widlar, and the ability of integrating it onto a monolithic amplifier, eliminates the external circuitry and long design time required in a discrete amplifier design.

SPIke protected audio amplifiers are safeguarded from Thermal runaway, an area of concern for any complementary-symmetry amplifier. Thermal runaway is an excessive amount of heating and power dissipation of the output transistor from an increased collector current caused by the two complementary transistors not having the same characteristics or from an uncompensated V_{BE} being reduced by high temperatures.

If proper heatsinking is not utilized, the die will heat up due to the poor dissipation of power when the amplifier is being driven hard for a long period of time. Once the die reaches its upper temperature limit of approximately 165°C , the thermal shutdown protection circuitry is enabled, driving the output to ground. A pseudo "pop" at the output may occur when this point is reached, due to the sudden interruption of the flow of music to the speaker. The device will remain off until the temperature of the die decreases about 10°C to its lower temperature limit of 155°C . It is at this point that the device will turn itself on, again amplifying the input signal.

As can be seen in *Figures 14 and 15*, the junction temperature vs time graph and the response to the activation of the thermal shutdown circuitry perform in a Schmitt trigger fashion, turning the output on and off, thus regulating the temperature of the die over time when subjected to high continuous powers with improper heatsinking.

The intention of the protection circuitry is to prevent the device from being subjected to short-term fault conditions that result in high power dissipation within the amplifier and thus transgressing into thermal runaway. If the conditions that cause the thermal shutdown are not removed, the amplifier will perform in this Schmitt trigger fashion indefinitely, reducing the long-term reliability of the device.

The fairly slow-acting thermal shutdown circuitry is not intended to protect the amplifier against transient safe operating area violations. SPIke protection circuitry will perform this function.

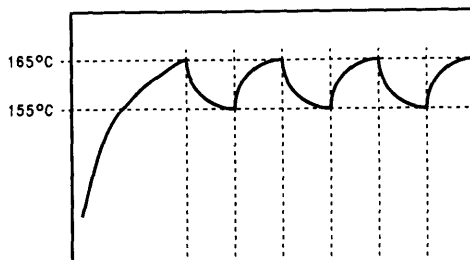

TL/H/11869-17

FIGURE 14. Junction Temperature vs Time

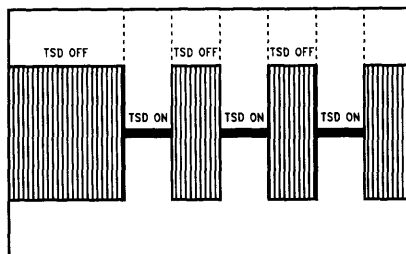

TL/H/11869-18

FIGURE 15. Thermal Shutdown Waveform

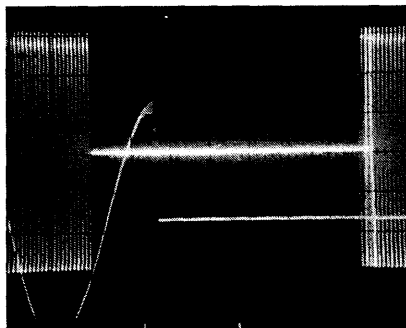

TL/H/11869-19

FIGURE 16. Actual Thermal Shutdown Waveform