



## ePanorama.net - Audio Documents

### SPDIF

#### History

Since the early 80's, a step towards digital audio has been set by the introduction of the Compact Disc player. In the beginning, those signals stayed inside the set, and were converted to analog signals before leaving the cabinet. A new trend is to keep signals into the digital domain as long as possible, because this is the only way to keep the signal quality. To make this possible different devices must be able communicate with one another within the digital domain. Several interfaces exist to perform such tasks, from which one has grown to the audio standard worldwide: IEC958 1989-03 (consumer Part) from the EBU. In Japan an equivalent EIAJ CP-340 1987-9 is standard.

#### Characteristics

Standard IEC958 "Digital audio interface" from EBU (European Broadcasting Union) details:

- Audio format : linear 16 bit default, up to 24 bit expandable
- Allowed sampling frequencies (Fs) of the audio:
  - 44.1kHz from CD
  - 48 kHz from DAT
  - 32 kHz from DSR
- One way communication: from a transmitter to a receiver.
- Control information:
  - V (validity) bit : indicates if audio sample is valid.
  - U (user) bit : user free coding i.e. running time song, track number.
  - C (channel status) bit : emphasis, sampling rate and copy permit.
  - P (parity) bit : error detection bit to check for good reception.
- Coding format: biphasic mark except the headers (preambles), for sync purposes.
- Bandwidth occupation : 100kHz up to 6Mhz (no DC!)
- Signal bitrate is 2.8Mhz (Fs=44.1kHz), 2Mhz (Fs=32kHz) and 3.1Mhz (Fs=48kHz).

Physical connection:

- Cable: 75ohm +/-5% (l<10m) or 75ohm +/-35% (l>10m)
- Line driver:
  - Zout: 75ohm +/-20% (100kHz .. 6Mhz)
  - Vout: 0.4Vpp .. 0.6Vpp, <0.05Vdc (75ohm terminated)
- Line receiver:
  - Zin: 75ohm +/-5%
  - Vin: 0.2Vpp .. 0.6Vpp

#### The interface

IEC958 is a newer standard which supersedes AES/EBU and also S-PDIF. The S/PDIF interface (IEC-958) is a 'consumer' version of the AES/EBU-interface. The two formats are quite compatible with each other, differing only in the subcode information and connector. The professional format subcode contains ASCII strings for source and destination identification, whereas the commercial format carries the SCMS.

Here is a short comparison table of AES/EBU and S/PDIF interfaces:

	AES/EBU	S/PDIF (IEC-958)
Cabling	110 ohm shielded TP	75 ohm coaxial or fiber
Connector	3-pin XLR	RCA (or BNC)
Signal level	3..10V	0.5..1V
Modulation	biphase-mark-code	biphase-mark-code
Subcode information	ASCII ID text	SCMS copy protection info
Max. Resolution	24 bits	20 bits (24 bit optional)

NOTE: AES/EBU also exists in 75 ohm/BNC version (AES-3id-1995 standard). 75 ohm BNC version of AES/EBU is very electrically similar to 75 ohm coaxial S/PDIF shown above.

The electrical characteristics of AES/EBU are based on on RS-422, so basically any differential RS-422 chip will do as the receiver and transmitter chips. S/PDIF coaxial interface is not specifically based on any other standard I know of (but is quite similar in signal levels and bandwidth requirements to some video signals).

Both S/PDIF and AES/EBU can, and do transfer 24 bit words. In AES/EBU, the last 4 bits have a defined usage, so if anyone puts audio in there, it has to go to something that doesn't expect the standard specifies. But in S/PDIF, there's nothing that says what you have to use the bits for, so filling them all up with audio is acceptable. Typical S/PDIF equipments only use 16 or 20 bit resolutions. While many equipments use more than 16 bits in internal processing, it's not unusual for the output to be limited to 16 bits.

#### Note on HDR-2 (2 pin header) interface used in some PC products:

Many modern PC CD-ROM drives and some soundcards (SB32, AWE32, etc.) have a two pin digital output connector in the back of the drive and they sometimes call that interface S/PDIF. Unfortunately the electrical signal which comes from it is not exactly what is described in S/PDIF specifications. The data format is exactly the same, but the signal is TTL level (5Vpp) signal instead of the normal 1Vpp signal. The output level might be selected to make the interfacing to other digital electronics easy when signal is travelling inside the computer (the normal output driver system and input amplifiers can be avoided). The downside of this is that you need to build some electronics to make the signal from the CD-ROM drive to match what normal S/PDIF equipments expect.

#### Multi channel audio and S/PDIF

IEC958 was named IEC60958 at 1998. IEC60958 (The S/PDIF) can carry normal audio and IEC61937 datastreams. IEC61937 datastreams can contain multichannel sound like MPEG2, AC3 or DTS. When IEC61937 datastreams are transferred, the bits which normally carry audio samples are replaced with the databits from the

datastream and the headers of the S/PDIF signal. Channel-status information contains one bit (but 1) which tells if the data in S/PDIF frame is digital audio or some other data (DTS, AC3, MPEG audio etc.). This bit will tell normal digital audio equipments that they don't try to play back this data as they were audio samples. (would sound really horrible if this happens for some reason).

The equipments which can handle both normal audio and IEC61937 just look at those header bits to determine what to do with the received data.

## Cabling details

S/PDIF (IEC-958) uses 75 ohm coaxial cable and RCA connectors. 75 ohm coaxial cable is inexpensive, because it is the same cable as used in video transmission (you can buy a video cable with RCA connectors to connect you S/PDIF equipments together). Coaxial S/PDIF connections work typically at least to 10-15 meter distances with good 75 ohm coaxial cable.

AES/EBU-interface uses the well known symmetrical connections with transformer isolation and an output impedance of 110 ohm. The signal-level of this interface is reasonably higher than in the consumer version (3...10 volts). Because AES/EBU digital audio signals are transmitted at high, video-like frequencies (at around 6MHz) and should be handled very differently than standard analog audio lines. Commonly used XLR-3 microphone cables have various impedance ratings (30 ohm to 90 ohm typical) and exhibit poor digital transmission performance. The result is signal drop out and reduced cable lengths due to severe impedance mis-matching (VSWR) between AES/EBU 110 ohm equipment. AES/EBU signal transmission work for few tens of meters with a good cable.

There also an optical version of S/PDIF interface which is usually called Toslink, because uses Toslink optical components. The transmission media is 1 mm plastic fiber and the signals are transmitted using visible light (red transmitting LED). The optical signals have exactly the same format as the electrical S/PDIF signals, they are just converted to light signals (light on/off). Because high light signal attenuation in the Toslink fiberoptic cable, the transmission distance available using this technique is less than 10 meters (with some equipments only few meters).

## What can make difference in the sound of digital signal ?

There are two things which can cause differences between the sound of digital interfaces:

### 1. Jitter (clock phase noise)

This really only affects sound of the signal going directly to a DAC. If you're running into a computer, the computer is effectively going to be reclocking everything. Same applies also to CD-recorders, DAT tape decs and similar devices. Even modern DACs have typically a small buffer and reclocking circuitry, so the jitter is not so big problem nowadays that it used to be.

### 2. Errors

This usually causes very significant changes in the sound, often loud popping noises but occasionally less offensive effects. Any data loss or errors in either are a sign of a very broken link which is probably intermittently dropping out altogether.

## S/PDIF signals

The signal on the digital output of a CD-player looks like almost perfect sine-wave, with an amplitude of 500 mVt and a frequency of almost 3 MHz.

For each sample, two 32-bit words are transmitted, which results in a bit-rate of:

```
2.8224 Mbit/s (44.1 kHz samplingrate, CD, DAT)
3.072 Mbit/s (48 kHz sampling rate, DAT)
2.048 Mbit/s (32 kHz sampling rate, for satellite purposes)
```

The output impedance is standard 75 ohm, so ordinary coaxial cable designed for video applications can be used. The minimal input level of S/PDIF interface is 200 mVt which allows some cable losses. There is no real need for special quality cable as long as the cable is made of 75 ohm coaxial cable (a good video accessory cable works also as good S/PDIF cable).

## The Coding Format

The digital signal is coded using the 'biphase-mark-code' (BMC), which is a kind of phase-modulation. In this system, two zero-crossings of the signal mean a logical 1 and one zero-crossing means a logical 0.

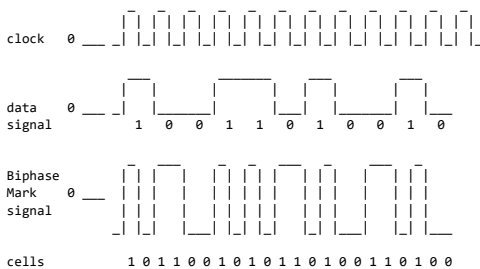

The frequency of the clock is twice the bitrate. Every bit of the original data is represented as two logical states, which, together, form a cell. The length of a cell ('time-slot') is equal to the length of a databit. The logical level at the start of a bit is always inverted to the level at the end of the previous bit. The level at the end of a bit is equal (a 0 transmitted) or inverted (a 1 transmitted) to the start of that bit.

The first 4 bits of a 32-bit word (bits 0 through 3) form a preamble which takes care of synchronisation. This sync-pattern doesn't actually carry any data, but only equals four databits in length. It also doesn't use the BMC, so bit patterns which include more than two 0's or 1's in a row can occur (in fact, they always do).

There are 3 different sync-patterns, but they can appear in different forms, depending on the last cell of the previous 32-bit word (parity):

Preamble	cell-order (last cell "0")	cell-order (last cell "1")
"B"	11101000	00010111
"M"	11100010	00011101
"W"	11100100	00011011

Preamble B: Marks a word containing data for channel A (left) at the start of the data-block.

Preamble M: Marks a word with data for channel A that isn't at the start of the data-block.

Preamble W: Marks a word containing data for channel B. (right, for stereo). When using more than 2 channels, this could also be any other channel (except for A).



The AES/EBU standard for serial digital audio uses typically 163 ns clock rate and allows up to +/-20 ns of jitter in the signal. This peaks to peak value of 40 ns is around 1/4 of the unit interval. D/A conversion clock jitter requirements are considerably tighter. A draft AES/EBU standard specifies the D/A converter clock at 1 ns jitter; however, a theoretical value for 16-bit audio could be as small as 0.1 nsec. Small jitter D/A conversion is implemented by using separate PLL clocks for data recovery and DAC and by using a buffering between data recovery and DAC.

## Conversion circuits

Here are some AES/EBU and S/PDIF circuit collected from various sources. The following circuit will only convert the signal levels, not other protocol details.

Remember that although the audio data is the same in both AES/EBU and S/PDIF interfaces, they are indeed different formats, at least in their subcode. AES converted to coax is NOT S/PDIF, and S/PDIF converted to XLR balanced is NOT AES. They are still their native format, just the transmission medium has changed. Whether they will work in your application depends on the equipment chosen.

Some DATs have a switch that selects one format or the other regardless of the physical interface, some just ignore what they don't understand (usually resulting in the generally positive benefit of ignoring SCMS encoding), and some indeed gag on the "other" format. But simply fixing the physical interface works far more often than it doesn't.

### How to do different conversions using the circuit below

Here are some ideas how to make the most common conversions using the circuits described below. Note: there is no guarantee that the information in this or the circuit are correct (they are believed to be correct but not tested by the author).

- AES/EBU to S/PDIF: There is complete circuit for this
- S/PDIF to AES/EBU: There is complete circuit for this
- S/PDIF to optical: S/PDIF coax input circuit followed with optical TOSLINK output
- Optical to S/PDIF: Optical TOSLINK receiver followed with S/PDIF output buffer circuit
- CD-ROM digital output to normal S/PDIF: S/PDIF output buffer circuit does this
- CD-ROM digital output to optical: Connect optical TOSLINK output circuit to CD-ROM output

For every other conversion combination you can think of you can find circuits on the list below. To build an adapter you need two parts connected after each other.

- First you need an input circuit which converts the input you want (coax,optical or AES/EBU) to TTL format (if the input is in TTL format you don't need any input circuitry)
- Connect a suitable output circuit with TTL input after the receiving electronics to give you the output format you want (coax,optical,AES/EBU,TTL)

After you have selected the suitable circuit parts, built them and attached them together you get the conversion circuit you want. If you need more than one output, you can connect few (1-4) output modules to one input circuitry to have more than one output.

### AES/EBU to S/PDIF signal level converter

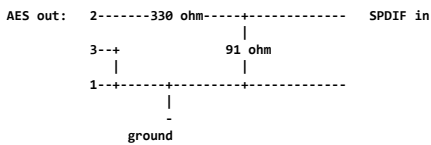

The idea for this circuit is taken from articles posted to Usenet News.

If you are looking for a professional components for 110 ohm to 75 ohm interconnection then check [Canare](http://Canare) web site where they have [110 OHM-75 OHM IMPEDANCE TRANSFORMERS](http://110 OHM-75 OHM IMPEDANCE TRANSFORMERS).

### S/PDIF to AES/EBU

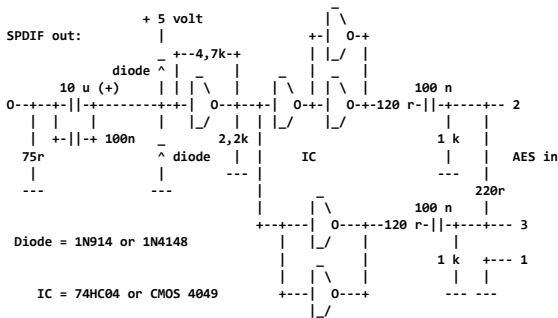

The idea for this circuit is taken from articles posted to Usenet News.

## S/PDIF conversion circuit building blocks

This is a collection of S/PDIF circuits found from various sources. The circuits are presented as building blocks which have one end on S/PDIF standard signal and other end an TTL level signal. The TTL level signal end of the circuits is designed to be the interface which you can use to wire different modules together to make whatever S/PDIF converter circuit you want. The circuit are presented as building blocks because with this approach you can most easily build a suitable circuit for all conversion needs.

Here are tips for building a conversion circuits for different uses:

- Coaxial S/PDIF to optical: Select any S/PDIF coaxial input circuit and connect it's TTL output to one optical S/PDIF (Toslink) output circuit.
- Optical S/PDIF to coaxial: Select one optical S/PDIF input circuit and connect it's TTL output to any coaxial S/PDIF output circuit.
- CD-ROM digital out to coaxial: CD-ROMs output TTL level S/PDIF, so get it to coaxial you just need a coaxial output circuit where you directly connect the digital signal from your CD-ROM drive.

For other conversion needs do a little thinking and you should find quite easily the answer what blocks to connect to each other.

### S/PDIF output buffer circuits

Here is set of output circuit which take in TTL level S/PDIF signal in and output standard S/PDIF coax cable output signal. Those output circuit are very useful building blocks for all kinds of S/PDIF related electronics projects. All the circuits do basically the same thing. They just use different components, so use the one where you can easily get components.

### S/PDIF output buffer circuit

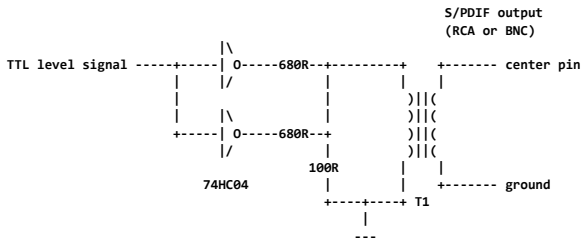

Idea for this circuit is taken from "A digital Output for the CD720" web page (was at <http://www.spiceisle.com/homepages/brian/audiody/mods/digi-out.htm>). The transformer T1 is high quality 1:1 pulse transformer (can be salvaged from old broken network interface card or similar source).

### Another S/PDIF output circuit

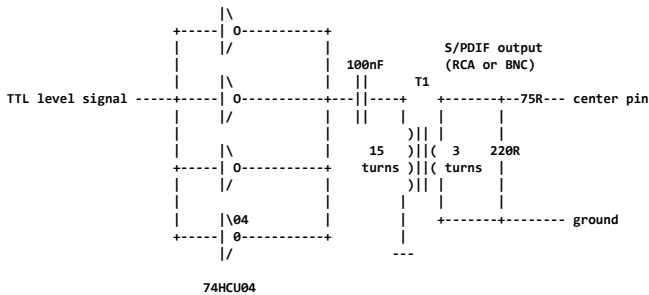

This circuit is part of circuit "Splitter for S/PDIF coax/optical output" by T. Giesberts from Elektor Electronics magazine July/August 1995 pages 78-79. The transformer T1 is made to G2.3-FT12 ferrite ring core. Primary coil is 15 turns of 0.5 mm diameter enamelled copper wire and secondary is 3 turns of 0.5 mm diameter enamelled copper wire. The chip 74HCU04 is manufactured by [Philips](#)

The circuit in the magazine had 3 outputs. The two extra output were made by adding two more output coils to T1 and the output resistors.

### Output circuit with transformer used as impedance matcher

This circuit is taken from Digital One V. 1.1 documentation. Digital One is from NET-Labs and is designed by by Enland Unruh.

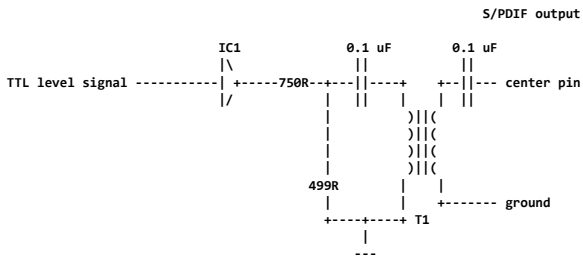

T1 is a HF-transformer which has 2:1 turns ratio. Transformer type used in example circuit is SC944-05. IC1 in this circuit consists of 8 parallel connected buffer ports from 74ACQ244 IC.

### Output with 1:1 pulse transformer

This is the recommended S/PDIF output circuit from [Crystal Semiconductor](#) CD4237 single chip multimedia audio system IC datasheet page 71.

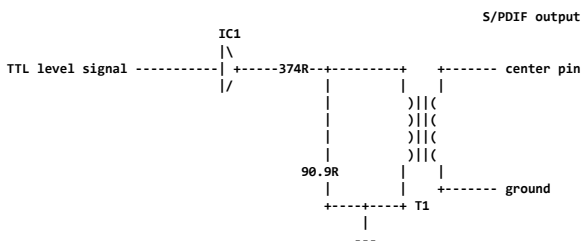

The transformer used in this circuit is 1:1 pulse transformer (the original application note suggested pulse transformer from Pulse Engineering or Schott Corporation). IC1 is a buffer IC which must be capable to supply enough current to drive the 75 ohm S/PDIF interface to full voltage swing specified (capable of loading 415 ohm load or capable of supplying 12 mA current).

### Simple S/PDIF output without galvanic isolation

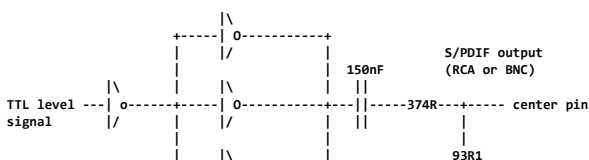

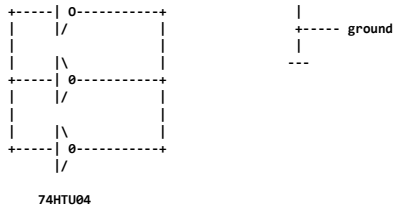

This circuit does not provide any isolation on the output. The TTL level signal from 74HCT04 buffer is attenuated to the levels specified in S/PDIF optical interface by using the voltage divider made of 374 ohm and 93.1 ohm resistors. This circuit is based on S/PDIF converter circuit diagram from Elektor Electronics magazine issue 4/1997 page 66.

### Simplest TTL to S/PDIF coax interface

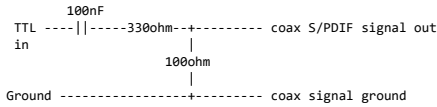

This circuit interfaces directly to the TTL level output provided by some sound equipment (CD-ROM or soundcard). This circuit works if the equipment which gives out TTL level has powerful enough TTL output to run this circuit (enough current output capability). If this simple circuit does not work reliably, then you need to build a circuit which includes the buffering electronics.

### Isolation transformer for S/PDIF output

If your equipment (for example sound cards) has an S/PDIF output which does not have an isolation transformer at the output, you can easily add the transformer to it by putting a suitable transformer after the original output.

Elektor Electronics magazine issue 7-8/1999 recommend building the transformer for S/PDIF isolation in the following way:

The transformer must have good coupling factor, so the transformer core must be a toroidal core made of high permeability material. The prototype described in the magazine uses Philips Type TN13/7.5/5-3E25 core which has permeability rating ( $\mu$ ) of 4500. The primary and secondary windings consisted of 6 turns of 0.5 mm diameter enamelled copper wire laid on opposite sides of toroid. The transformer used in this prototype was described to have a bandwidth ranged from 50 kHz to 17 MHz, which is more than adequate for an S/PDIF link.

The transformer should be fitted directly to the source and the receiving end must be properly terminated for reliable operation. The reason for this is that the transformer input and output impedances are not exactly 75 ohm.

## S/PDIF input circuits

The following circuits can be used to convert S/PDIF signals to TTL level signals which can be connected to any suitable output circuit or directly to digital electronics.

### S/PDIF coax input circuit

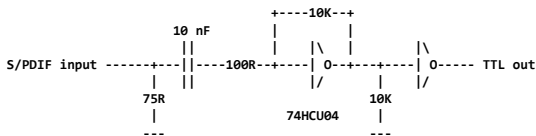

This circuit is part of circuit "Splitter for S/PDIF coax/optical output" by T. Giesberts from Elektor Electronics magazine July/August 1995 pages 78-79. The chip 74HCU04 is manufactured by [Philips](#)

### Another input circuit

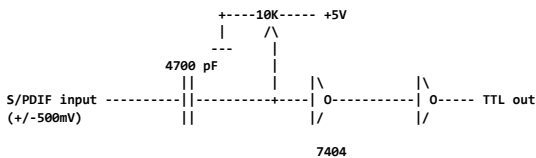

The capacitor works as DC blocking capacitor. 10 kohm trimpot signal raises its ground potential to the point that Hex Inverter IC1 recognizes the difference between a digital 1 and 0 input. When you first test the circuit then first adjust 10 kohm trimmer to the center and then adjust it so that the circuit receives the S/PDIF signal well. If you have a voltmeter, you can adjust the trimpot to show around 2.6V at pin 1 of the IC. The inverter buffers the input and produces TTL 0-5V output signal. This circuit does not provide the 75 ohm termination resistor, so you need to add it if you have problems because of cable signal reflections. This circuit is part of [Coax Digital Out to MD](#) circuit design.

## Optical S/PDIF output circuit

### Optical TOSLINK output

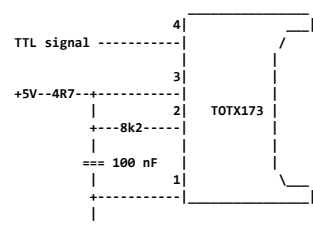

The 4.7 ohm resistor and 100 nF capacitor make a filter against digital noise in +5V power source. The Toslink transmitting module used in this circuit is [TOTX173](#) from [Toshiba](#). This circuit is a part of circuit diagram from Elektor Electronics magazine issue 4/1997 page 65.



## Other related information

### Who makes AES/EBU digital audio transceiver chips ?

[DSP FAQ](#) mentions that Sony, Crystal Semiconductor, Motorola and Yamaha have all AES/EBU transceiver chips available. [DSP FAQ](#) contain more information about AES/EBU chips at <http://tjev.tel.ef.hr/josip/DSP/FAQ/42.html>. Same companies which have AES/EBU chips have also SPDIF chips and some chips can handle both formats.

### Information sources

- [About SP-DIF](#) by DJ Greaves
- [DSP FAQ](#)
- Elektor Electronics magazine July/August 1995 pages 78-79
- Public domain S/PDIF document found in in the net (that article did not mention the author name)
- David K. Fibush, Jitter Effect and Measurement in Serial Digital Television Signals, SMPTE Journal, August 1993, pages 693-698
- Various articles from usenet newsgroups sci.electronics.design, rec.audio.pro and rec.audio.tech
- [Super-Cheap TOSLINK Module](#) web page

---

[ [webmaster](#) ] [ [feedback](#) ] [ [friend](#) ] [ [main index](#) ] [ [Disclaimer](#) ] [ [Legal Notice](#) ]

Published by ELH Communications Ltd. all rights reserved.