

# Application Note

## LC Filter Design With MLCCs: Why The Applied Voltage Matters



ANP062 // FRANK PUHANE

### 1 Introduction

The demand for ever more compact electronic circuits (such as switching power supplies) has effects not only on the choice of active components, but also on the choice of passive components for the associated filter system to damp interference. The opportunities that exist today for discrete design thanks to ever-smaller casings also demand smaller discrete filter components. LC filters, for example, often used to be constructed using aluminum electrolytic capacitors because these offer a very wide range of capacitance values. This advantage, however, is becoming increasingly small, as advances in ceramic capacitor technology have enabled the production of high-capacitance SMD ceramic capacitors (multilayer ceramic chip capacitors – MLCCs).

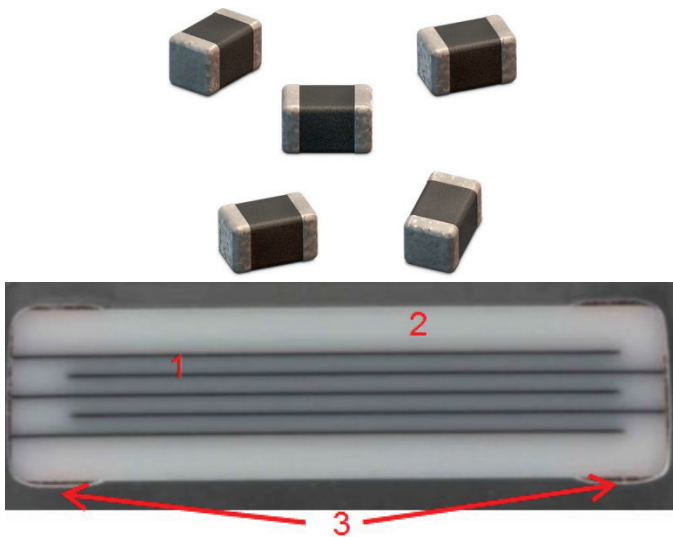

**Figure 1: structure of an MLCC: 1 = conductive electrodes, 2 = ceramic material, 3 = contact surfaces.**

This can be a massive advantage in terms of space, but it also has its drawbacks. Therefore, this application note takes a closer look at the considerable influence of DC voltage on the capacitor, and hence the filter design. The focus is on an LC low-pass filter, as used as an input or output filter for switching regulators or a power supply filter for a module.

### 2 Types and Properties of MLCCs

MLCCs can essentially be divided into two types: those using class 1 ceramics, and those using class 2 ceramics. Ceramics are very brittle materials, and their mechanical fragility increases with size. Therefore, the maximum size of MLCCs is limited, and care must be taken in the layout to reduce mechanical forces. Class 1 and class 2 ceramics differ in various ways. Table 1 shows the technical properties of ceramics currently used by Würth Elektronik.

	Class 1 ceramics	Class 2 ceramics
<b>Material</b>	Titanium dioxide (TiO <sub>2</sub> )	Barium titanate (BaTiO <sub>3</sub> )
<b>Permittivity</b>	> 10...500	> 500...10000
<b>Capacitance range</b>	1 pF to 33 nF	100 pF to 100 μF
<b>Voltage range</b>	10 V to 50 V	6.3 V to 100 V
<b>Size</b>	0402 to 1812	0402 to 1812
<b>Voltage-dependent</b>	No	Yes
<b>Frequency-dependent</b>	Yes	Yes
<b>Temperature-dependent</b>	No	Yes
<b>Ageing</b>	No	Yes

**Table 1: Overview of the technical properties of ceramics currently used by Würth Elektronik.**

The properties and tolerances of the different ceramic classes are defined by the IEC or EIA coding system. These standards are shown in figures 2 and 3. It should be mentioned that the IEC 60384-21 coding system is not normally used for class 1 ceramics, but there is one very well-known term: NPO. This has the same meaning as EIA code COG. This is shown in figure 2. NPO has a very small tolerance over its temperature range: +/-30 ppm/°C. EIA coding is typically used with class 2 ceramics, including ceramics such as X7R or X5R. Depending on the application, the capacitor must have a particular capacitance to obtain the desired performance – e.g. for filtering. The relationship of this to temperature is shown in figure 4. X7R means that the capacitance may not vary by more than +/-15 % between -55 °C and +125 °C. Thus, the capacitance value for a 10 μF class 2 ceramic may vary between 8.5 μF and 11.5 μF within the permitted temperature range. Any ceramic mixture that has this property is an X7R ceramic. In addition to this tolerance, there is also the manufacturer's delivery tolerance on the day of delivery. This is typically a further +/-10 %.

# Application Note

## LC Filter Design With MLCCs: Why The Applied Voltage Matters



1st character		2nd character		3rd character	
Letter	Temperature coefficient TC (ppm/°C)	Number	Multiplier	Letter	Tolerance of temperature coefficient TC (ppm/°C)
<b>C</b>	0.0	<b>0</b>	-1	<b>G</b>	± 30
<b>B</b>	0.3	<b>1</b>	-10	<b>H</b>	± 60
<b>L</b>	0.8	<b>2</b>	-100	<b>J</b>	± 120
<b>A</b>	0.9	<b>3</b>	-1000	<b>K</b>	± 250
<b>M</b>	1.0	<b>4</b>	+1	<b>L</b>	± 500
<b>P</b>	1.5	<b>6</b>	+10	<b>M</b>	± 1000
<b>R</b>	2.2	<b>7</b>	+100	<b>N</b>	± 2500
<b>S</b>	3.3	<b>8</b>	+1000		
<b>T</b>	4.7				
<b>V</b>	5.6				
<b>U</b>	7.5				

Figure 1: EIA codes for class 1 ceramics.

1st character		2nd character		3rd character	
Letter	Lower temperature limit	Number	Upper temperature limit	Letter	Capacitance change over permitted temperature range
<b>X</b>	-55 °C	<b>2</b>	+45 °C	<b>A</b>	± 1.0 %
<b>Y</b>	-30 °C	<b>4</b>	+65 °C	<b>B</b>	± 1.5 %
<b>Z</b>	+10 °C	<b>5</b>	+85 °C	<b>C</b>	± 2.2 %
		<b>6</b>	+105 °C	<b>D</b>	± 3.3 %
		<b>7</b>	+125 °C	<b>E</b>	± 4.7 %
		<b>8</b>	+150 °C	<b>F</b>	± 7.5 %
		<b>9</b>	+200 °C	<b>P</b>	± 10 %
				<b>R</b>	± 15 %
				<b>S</b>	± 22 %
				<b>T</b>	+22 % / -33 %
				<b>U</b>	+22 % / -56 %
				<b>V</b>	+22 % / -82 %

Figure 3: EIA codes for class 2 ceramics.

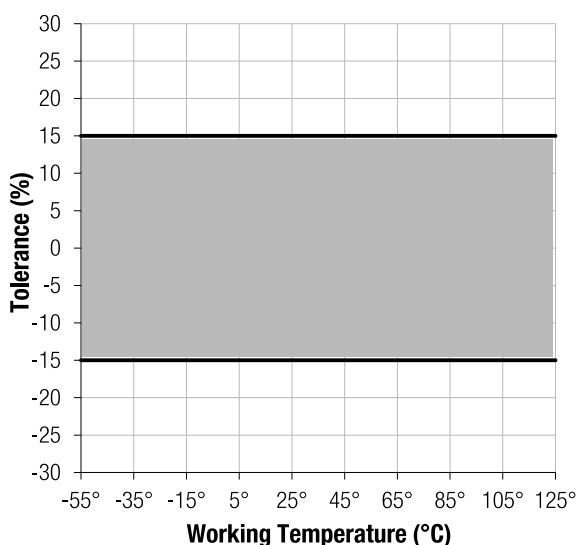

Figure 4: range of tolerance of an X7R ceramic.

The ceramic class or code does not, however, define the composition of an X7R ceramic (powder particle size, material mix, etc.). Moreover, any ceramic capable of holding its capacitance within the stated tolerance window across the temperature range can be described as X7R. This can vary between manufacturers. Therefore, the properties of the individual components must be closely compared to ensure the desired characteristics are obtained.

The so-called DC bias effect, i.e. the voltage dependence of the capacitance, has a very large influence on the capacitance. With class 2 ceramics, applied voltage causes a drop in capacitance. This is due to the internal structure of the barium titanate used as the base material. Using barium titanate does produce highly permeable ceramics, but these also have internal structures that respond to and become polarised by external electric fields. This results in a certain saturation of the material, and in turn leads to a drop in capacitance. This characteristic is comparable to the saturation of ferromagnetic materials (e.g. ferrite material). Therefore, this material is also said to have ferroelectric properties. This

# Application Note

## LC Filter Design With MLCCs: Why The Applied Voltage Matters



relationship is illustrated in figure 5. It's taken from the online-platform [REDEXPERT](#) by Würth Elektronik ([link](#)) and shows the percentage decrease in capacitance with applied voltage, in this case using part no. WCAP-CSGP 885 012 206 026 (1  $\mu$ F, 0603, 10 V, X7R) as an example.

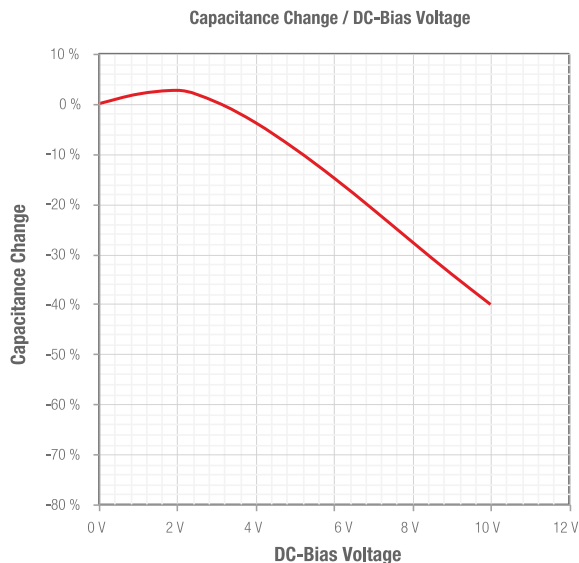

**Figure 5: voltage-dependent capacitance characteristics of. 885 012 206 026 (1  $\mu$ F, 0603, 10 V, X7R).**

Another effect can be used to prove that these are real measured data. At low voltage, this capacitor demonstrates a certain self-healing effect of the ceramic material. This could also be thought of as the ceramic needing to be 'woken up' first. When voltage is applied, the healing and polarization process starts. Above a certain applied voltage (about 2.1 V in the example), the material becomes saturated and the available capacitance will be reduced. This characteristic must be recorded and examined for each individual component. With approximately 800 current catalogue items in the MLCCs category, this is a very laborious process. Würth Elektronik has recorded these data for every MLCC in its portfolio and integrated them into the [REDEXPERT](#) online-platform.

### 3 Filter Design

The effect of voltage-dependent capacitance must be individually considered when selecting a capacitor for the application in question. A certain capacitance is required from the output capacitor of a switching power supply to keep the control circuit stable, and thus the output voltage as well. If the set output voltage reduces the capacitance value, this will affect the control circuit. This will affect characteristics such as ripple, or behavior with sudden changes in load, and may lead to the specification not being met. With a filter placed at the input, e.g. for the switching frequency of a step-down converter (the input is always the critical side for step-down

converters), the specified input voltage range of the converter and thus the applied voltage at the filter must be considered. Otherwise, fluctuation of the filter's cutoff frequency will occur, impairing the operation of the filter and possibly leading to failure of the EMC test due to conducted interference.

#### 3.1. The LC Filter

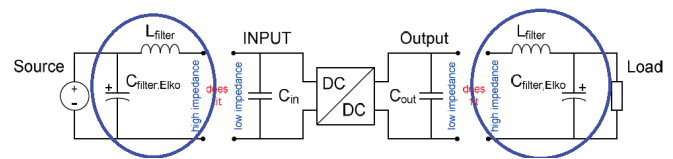

**Figure 6: LC filters at the input and output of a voltage converter.**

The LC filter is the filter type most widely and frequently used in electronics, and is constructed from an inductor and a capacitor. Since this is a second order filter, it has a fall of -6dB at its cutoff point and steepness of 40dB/decade. A filter must generally have at least one frequency-dependent component. The cutoff frequency of a LC filter can be determined using the following formula:

$$f_0 = \frac{1}{2\pi \cdot \sqrt{L \cdot C}} \quad (1)$$

Potential (excessively) high inrush currents are an important consideration when using a LC filter with an SMD ferrite, such as at the input of a switching regulator. Pulse-like inrush currents many times larger than the SMD ferrite's rated current can destroy the ferrite in the long term. The [WE-MPSB](#) series of components can be used to remedy this. These have a specified pulse tolerance. Another point to consider when using SMD ferrites is the relationship between their impedance and the current flowing through them. The impedance is reduced by saturation of the ferrite material; depending on how high this current is, because a chip bead ferrite has no air gap. This also changes the filter properties. This relationship can also be reproduced in [REDEXPERT](#) ([link](#)). Figure 7 shows an example of this characteristic, using component [WE-CBF 742792113](#).

# Application Note

## LC Filter Design With MLCCs: Why The Applied Voltage Matters

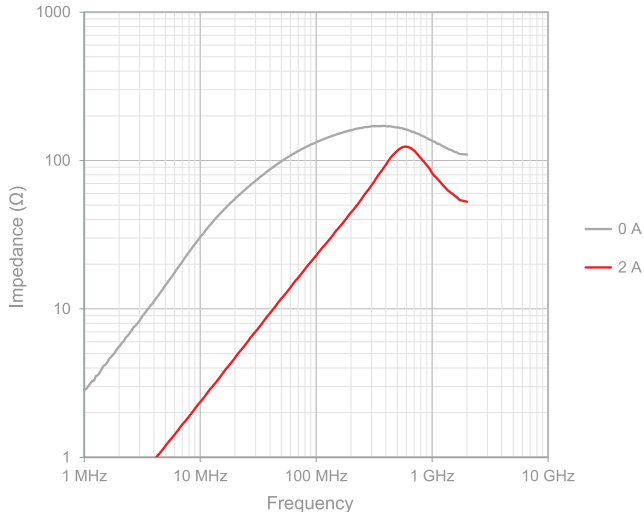
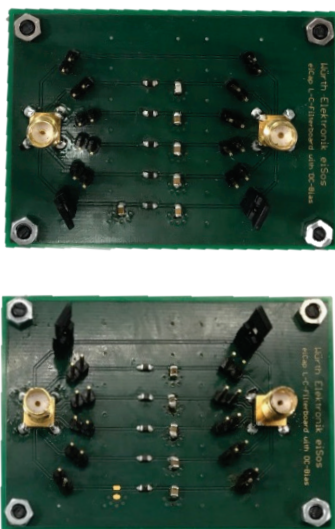

**Figure 7: change of impedance of an SMD ferrite with current (grey = 0 A, red = 2 A).**

This relationship of inductance and current flow is an important aspect of filters, although it will not be discussed in any more detail in this application note. For more information, please refer to [2] or similar sources.

### 3.2. Practical Example

The following example examines the voltage-dependency of capacitors in relation to their filter characteristics through the construction of two filter boards with various LC filter combinations and  $\pi$  filters. The two filter boards are shown in figure 8.



**Figure 8: completed filter boards.**

The inductor used is the same for all measurements. SMD ferrite [WE-CBF 742792093](#) was selected. The key inductive characteristic – the inductance value – can be determined from either the

impedance curve or the equivalent circuit diagram in LTspice. As all data are available in LTspice, the inductance was read off from the equivalent circuit diagram and amounts to 1.5  $\mu\text{H}$ . The filter capacitors were selected from the [WCAP-CSGP 0805](#) series.

The structure of the two filter boards is identical, with each having four LC filter combinations and one  $\pi$  filter. The  $\pi$  filter, however, was dispensed with on the second board in order to show the behavior of another high-capacitance MLCC. For this purpose, class 2 ceramic capacitors (X5R) with values of 47  $\mu\text{F}$ , 22  $\mu\text{F}$ , 10  $\mu\text{F}$ , 4.7  $\mu\text{F}$  and 3.3  $\mu\text{F}$  were selected. [Link to REDEXPERT.](#)

The behaviour of a class 1 ceramic capacitor (10 nF, 6.3 V, NPO) at its rated voltage can also be shown using the first board. Two 2.2  $\mu\text{F}$  capacitors were also used on this filter board, one each of X7R and X5R, and both with a rated voltage of 6.3 V. Similarly, the voltage-dependent capacitance effect in a  $\pi$  filter can be examined as well. Two 1  $\mu\text{F}$ , 10 V, X7R capacitors were selected for this purpose. All the capacitors used on this board can be seen on the following [link](#). The cutoff frequency of the different filters can be determined using the equation (1). The calculation is shown for the first filter as an example (10 nF, 6.3 V, NPO) and can be similarly applied to the others:

$$f_G = \frac{1}{2 \cdot \pi \cdot \sqrt{L_{\text{Ferrite}} \cdot C_{\text{Capacitor}}}} = \frac{1}{2 \cdot \pi \cdot \sqrt{1.5 \mu\text{H} \cdot 10\text{nF}}} = 1.3 \text{ MHz}$$

The cutoff frequency of the LC filter with 2.2  $\mu\text{F}$  capacitors is 876 kHz. To set the cutoff frequency of the  $\pi$  filter near to that of the LC filter, two 1  $\mu\text{F}$  (10 V, X7R) capacitors were selected. The cutoff frequencies of the second filter board are as follows:

- 47  $\mu\text{F}$  → 19 kHz
- 22  $\mu\text{F}$  → 28 kHz
- 10  $\mu\text{F}$  → 41 kHz
- 4.7  $\mu\text{F}$  → 60 kHz
- 3.3  $\mu\text{F}$  → 72 kHz

SMA connectors were used at the input and the output. In order to be able to activate the individual filters, two jumpers were used per filter. As the measurements are made below 200 MHz, the jumpers have a sufficiently small effect.

# Application Note

## LC Filter Design With MLCCs: Why The Applied Voltage Matters



### 3.3. Design

Figure 9 shows the schematic layout of the boards. As can be seen from the diagram, all the filters are constructed in the same way.

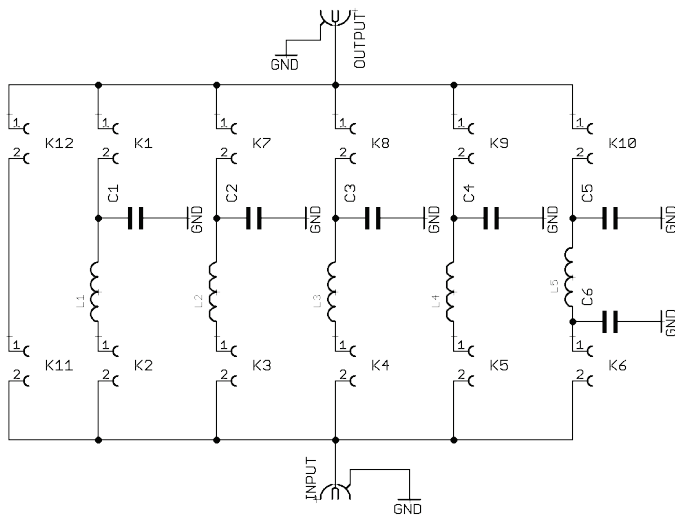

Figure 9: Circuit diagram of the filter boards

The layout is shown in figure 10. A GND guard has been dispensed with, as the assembly is mounted on a continuous ground plane. Each filter capacitor was connected by five plated-through holes.

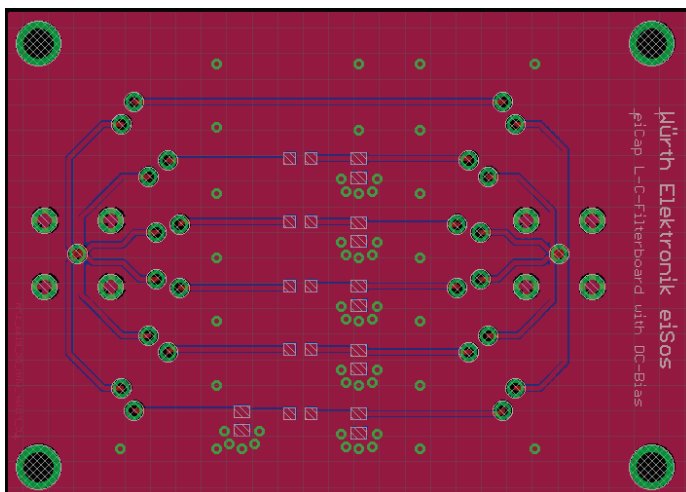

Figure 10: layout of the filter boards.

As can be seen in the picture, radial paths lead from the SMA connector to the filters. This can lead to reflections during measurement. However, these are not a problem in this case, since they do not occur until well over 200 MHz with the dimensions we are dealing with here. Figure 11 shows the complete filter boards, with the gold-coloured SMA connectors for the measurement ports. DC voltage is supplied via the first port. The DC block can be seen to the left of the lower filter board. This is very important for the following measurements, to avoid damaging the second port of the measuring equipment.

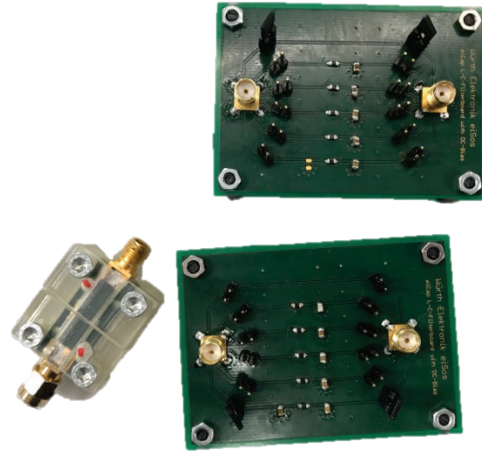

Figure 11: important DC block (left) and the two filter boards used.

### 3.4. Measurement Setup

An E561B network analyser from Agilent was used to measure filter characteristics by 2-port shunt-thru measurement.

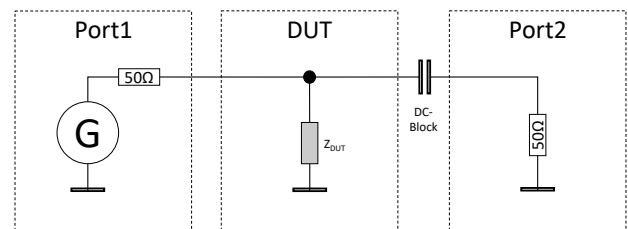

Figure 12: Equivalent circuit diagram or presentation of results.

The performance of the filter is typically stated in dB. In this case, however, filter impedance was determined in ohms, corresponding to equivalent impedance  $Z_{DUT}$ . This different approach does not change the shape of the filter curve, as low impedance indicates high damping. However, this representation enables effects of the MLCC under the influence of voltage to be identified more easily. The measurement setup is shown in figure 13.

The network analyser can deliver a voltage of up to 42 V at port 1 from an internal power supply. This is used to vary the capacitance and hence the filter characteristics as well. It is important to mention that a special DC block must be used for this type of measurement so as not to damage port 2 of the instrument.

# Application Note

## LC Filter Design With MLCCs: Why The Applied Voltage Matters

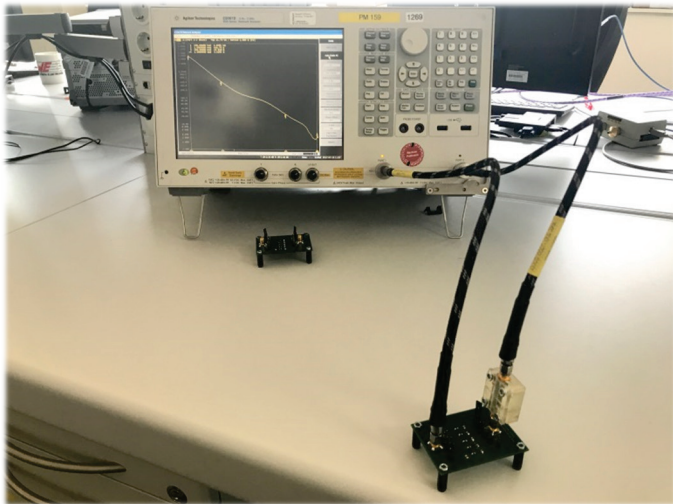

Figure 13: measurement setup used, with network analyser, test leads and filter boards.

### 3.5. Reference Line

Figure 14 shows the reference line of a filter board. As expected, the reference line does not form any 50R impedance, as it does not weaken the signal at low frequencies. So, at 1 MHz, the reference line corresponds to a shunt resistance of 3 k $\Omega$ . This also proves, by measurement, that neither the jumpers nor the layout affects the measurements.

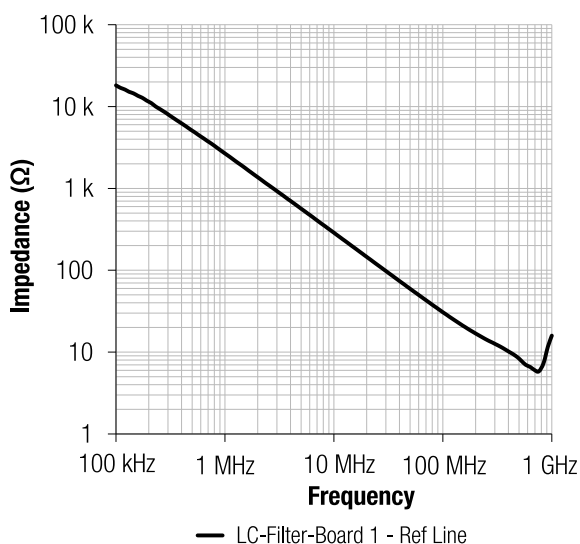

Figure 14: impedance curve of the reference line of filter board 1

Absorption circuit resonance due to the open filter connections can be seen on the extreme right of the diagram. These form a  $1/4\lambda$  stub at 750 MHz. Based on the industry standard that interference under  $1/10\lambda$  is negligible, an upper cutoff frequency of 300 MHz

(=  $750 \text{ MHz} \cdot (4/10)$ ) can be set for the measurement setup. This is thus above our 100 kHz - 200 MHz range.

Diverse combinations of source and sink impedance can be used for filters, so an arbitrary structure was chosen with these boards and the performance of different filters was studied.

### 3.6. Filter Board 1 With No Applied Voltage

In the following diagram (figure 15), all filters on the first filter board were measured with no applied voltage and are shown together on one chart. As the capacitance value of the NPO capacitor is very small, the resonant frequency shifts into the 80 MHz range. The LC filters with the 2.2  $\mu\text{F}$  capacitors, as well as the  $\pi$  filter, have – as expected – a similar resonant frequency of around 4.5 MHz.

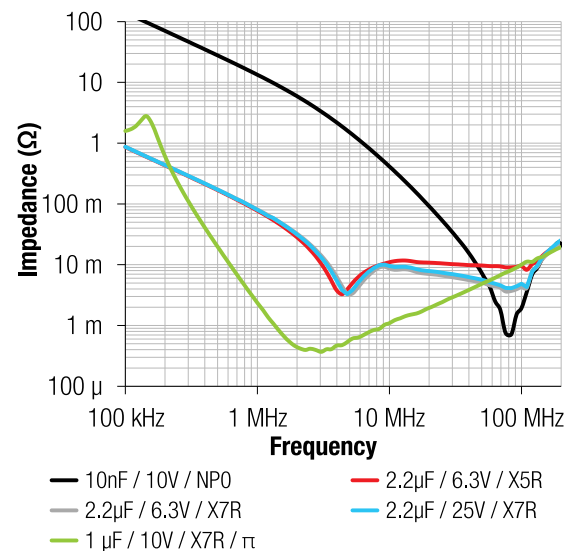

Figure 15: impedance curves of all filters on filter board 1, consisting of WE-CBF and WCAP-CSGP.

### 3.7. Class 1 Ceramics, 10 nF

Figure 16 shows the properties of a class 1, size 0805 ceramic capacitor with 10 nF capacitance and 10 V rated voltage. As was to be expected, this is not dependent on the applied voltage, as a class 1 ceramic not containing barium titanate was used here.

# Application Note

## LC Filter Design With MLCCs: Why The Applied Voltage Matters

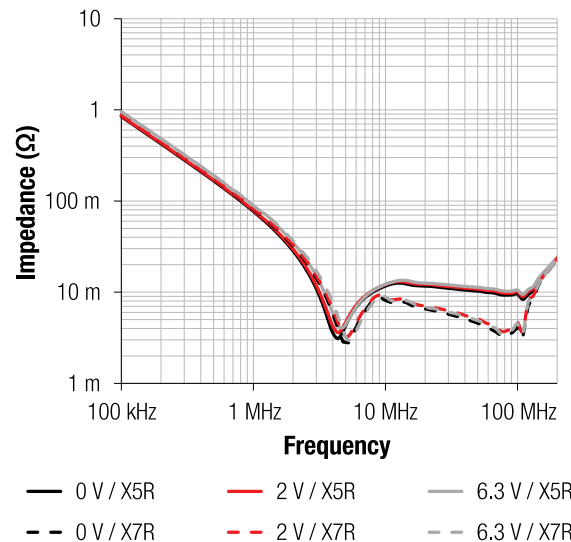
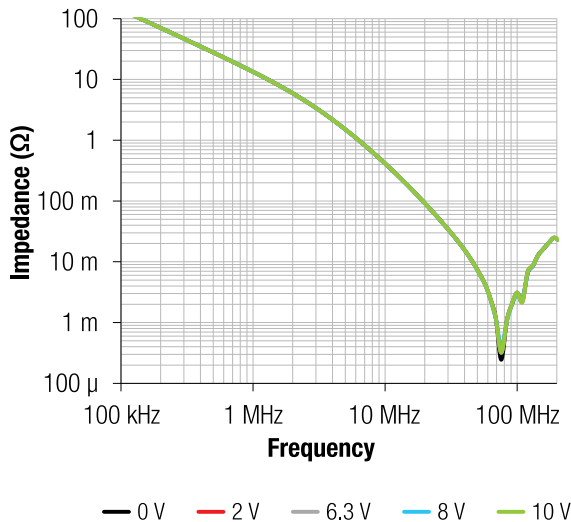

**Figure 16:** LC filter consisting of WE-CBF (742 792 095) and a 10nF, NP0, WCAP-CSGP ceramic capacitor (885 012 007 009).

**Figure 17:** filter properties of X5R (solid line) and X7R (dotted line) ceramics with the same capacitance and voltage values (2.2  $\mu$ F / 6.3 V / 0805).

### 3.8. MLCC 0805, 2.2 $\mu$ F, 6.3 V, X5R and X7R

Figure 17 shows the properties of class 2 X5R and X7R ceramics, with a maximum applied voltage of 6.3 V. As can be seen in the diagrams, the capacitance changes very little at the maximum voltage. That means that 2.2  $\mu$ F, 6.3 V, 0805 MLCCs still have a lot of ceramic material between the layers, and so this does not need to be highly permeable. Thus, the DC bias effect hardly occurs.

### 3.9. MLCC 0805, 2.2 $\mu$ F, 25 V, X7R

In the following figure 18, the full rated voltage is applied to a 2.2  $\mu$ F, 25 V capacitor. Two effects can be seen here. Due to the DC bias effect, capacitance is reduced by 69 % to 0.68  $\mu$ F. This causes the resonance point of the filter to shift. The piezoelectric effect of the class 2 ceramic can also be seen (green circle). This can lead to noise generation due to the structure contracting in the capacitor, and can even produce audible sound. The green double arrow illustrates the increased impedance (reduced damping) due to the shifted resonance point. The impedance at 4 MHz thus increases from 3 m $\Omega$  to 30 m $\Omega$ .

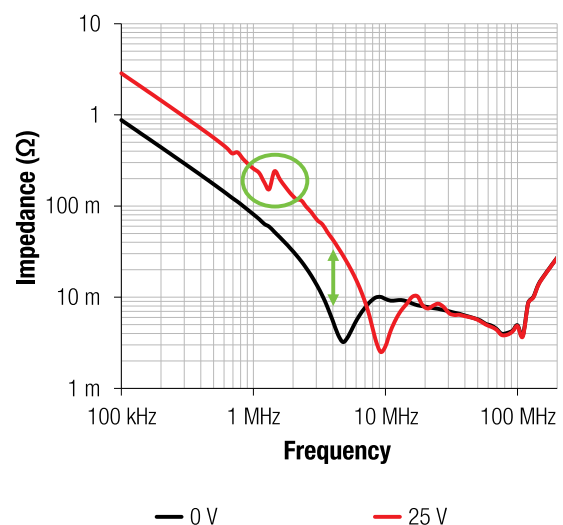

**Figure 18:** piezoelectric effect from application of rated voltage. WE-CBF 742 792 095, WCAP-CSGP 885 012 207 079.

### 3.10. MLCC 0805, 1 $\mu$ F, 10 V, X7R – $\pi$ filter

Capacitance is reduced in the  $\pi$  filter as well. Because it is a 1  $\mu$ F, 10 V, X7R capacitor, the applied voltage has a stronger effect, but not as strong as with a normal LC filter. The DC bias effect can thus also be counteracted by the filter design. This can be seen in figure 19.

# Application Note

## LC Filter Design With MLCCs: Why The Applied Voltage Matters

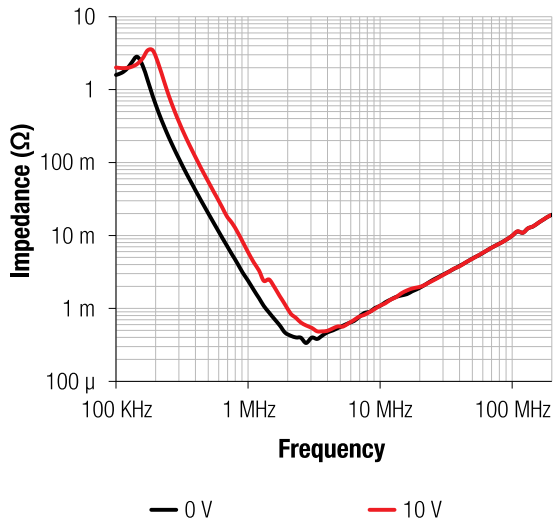

Figure 19: effect of applied voltage on a  $\pi$  filter.

### 3.11. Filter Board 2 with no Voltage applied

For filter board 2, ceramic capacitors with the same voltage range and of the same size were selected. The capacitance, however, was reduced with each filter. Figure 20 shows the impedance curves of all of the filters with no applied voltage. Because the capacitance value changes with each filter, the first resonance frequency of the filter changes as well. The second remains constant because the SMD ferrite is not changed, meaning that the parasitic effects remain the same. If we consider the highest capacitance value, the voltage dependence effect of the capacitance becomes very clear. If a voltage of 6.3 V is applied to the filter, the capacitance changes from 47  $\mu\text{F}$  to 10  $\mu\text{F}$ . This means an 80 % loss of capacitance. At this capacitance value and the specified size of 0805, there is only a very small amount of ceramic material left between the layers. Very permeable material is therefore required, bringing the DC bias effect strongly to the fore and causing this component to 'saturate' very quickly. The more the rated capacitance is reduced, the less the DC bias effect occurs. This is due to the internal structure of the ceramic capacitors.

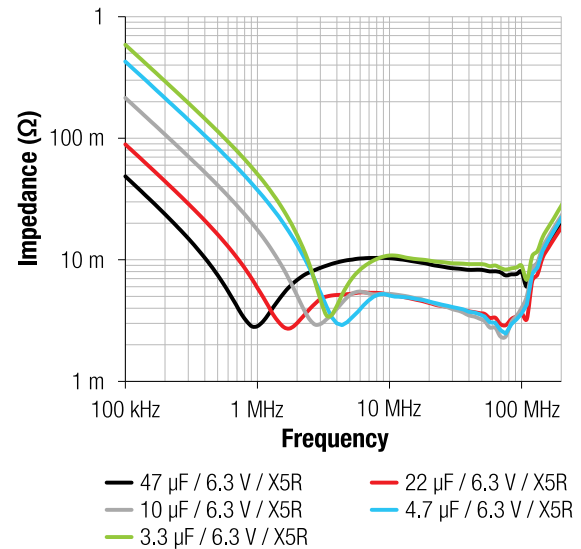

Figure 20: impedance curves of all the filters on filter board 2 with voltage applied.

The curves on the next page show filter properties as a function of the DC bias effect, at capacitance values of 47  $\mu\text{F}$  to 3.3  $\mu\text{F}$ .



# Application Note

## LC Filter Design With MLCCs: Why The Applied Voltage Matters

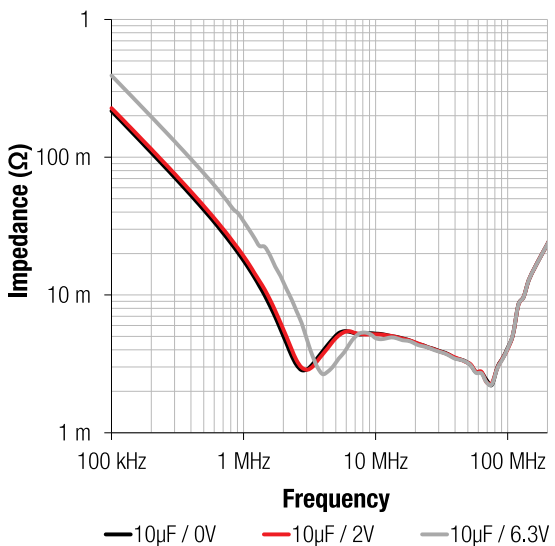
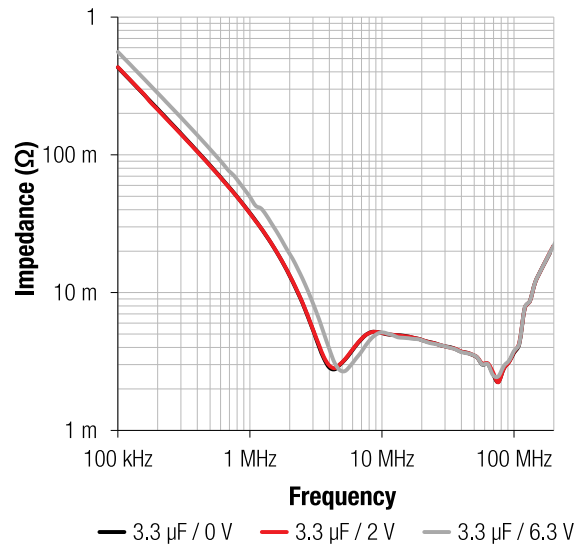
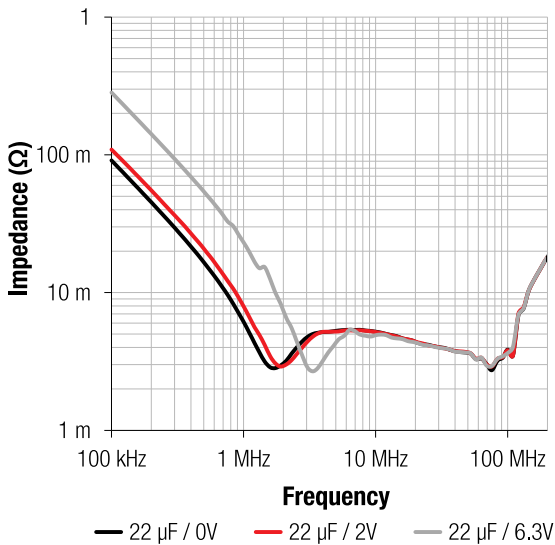
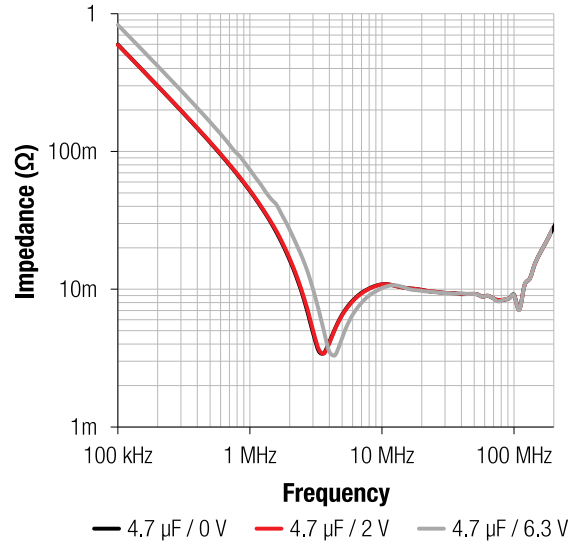
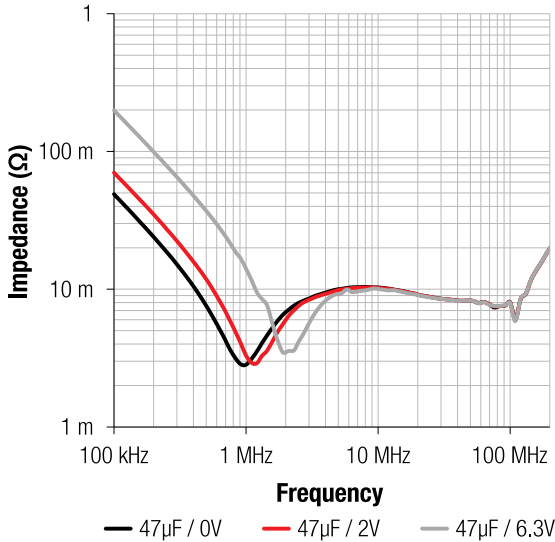

Figure 21 a-e: filter properties of 47 µF, 22 µF, 10 µF, 4.7 µF and 3.3 µF capacitances up to the rated voltage.

Capacitor	Resonance at 0V	Resonance at 6.3V	Difference
47 µF / 0805 / 6.3 V / X5R	950kHz	2.0MHz	110%
22 µF / 0805 / 6.3 V / X5R	1.8MHz	3.2MHz	77%
10 µF / 0805 / 6.3 V / X5R	2.8MHz	4.0MHz	43%
4.7 µF / 0805 / 6.3 V / X5R	3.5MHz	4.3MHz	22%
3.3 µF / 0805 / 6.3 V / X5R	4.5MHz	5MHz	19%

Table 2: overview of resonance shift with voltage applied.

# Application Note

## LC Filter Design With MLCCs: Why The Applied Voltage Matters



### 3.12. Other Opportunities with Filter Capacitors

As mentioned in previous chapters, high-capacitance ceramic capacitors of  $>1 \mu\text{F}$  are available, but are quite expensive. These high-capacitance MLCCs are also strongly dependent on the applied voltage, as seen in the previous chapter. SMD aluminum electrolytic capacitors (such as the [WCAP-ASLI](#) series) can be resorted to if larger capacitance values are required. Changing over to aluminum electrolytic capacitors can offer a price advantage in exactly this situation. Care must be taken over the permissible ripple current when selecting aluminum electrolytic capacitors. Aluminum polymer electrolytic capacitors (e.g. the [WCAP-PSLC](#) series) offer an alternative if greater longevity, low ESR values or high capacitance values are required. Aluminum polymer capacitors also have cost advantages over high-capacitance ceramic capacitors. Similarly, aluminum and aluminum polymer electrolytic capacitors exhibit no DC bias characteristics – unlike ceramic capacitors – meaning that an excessive capacitance value is not required to yield a certain capacitance.

## 4 Simulation of Measured Results

The voltage-dependency of class 2 ceramic capacitors, which was shown in the previous chapter by various measurements, can also be simulated with LTSpice. However, specific data are required for this. The LTSpice standard library includes a model of the real SMD ferrite. The LTSpice library from Würth Elektronik includes models of the capacitors. This can be downloaded from the Würth Elektronik [website](#). This leaves the question of how to obtain capacitance values as a function of applied voltage. These can be extracted from [REDEXPERT](#), as shown in figure 23 with an applied voltage of 10 V.

The change in capacitance / DC bias voltage graph only shows up to -50% of the nominal capacitance. These capacitance changes are enormous, so the depiction here is limited. Nevertheless, all values up to the maximum rated voltage are measured and stored. If the slider is moved further towards the rated voltage (from left to right), the data for the voltage setting in question can be read off from the table. These data can then be transferred to LTSpice.

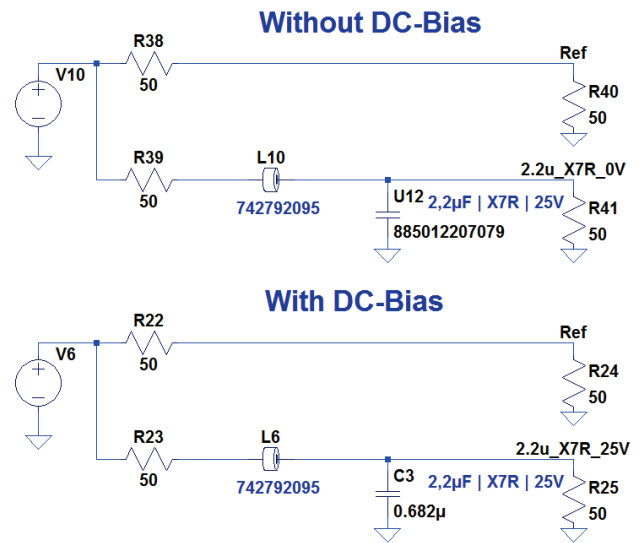

Figure 23: simulation of capacitor behavior with voltage applied.

This enables real filters to be constructed and very accurate results achieved. As can be seen in figure 15, the filter curve shifts when the capacitance changes.

Artikel-Nr.	Serie	Bauform	Spez	Typ	Artikel...	C	U <sub>R</sub>	R <sub>iso</sub>	ΔC(V <sub>DC-Bias</sub> ) @10,0 V
88501220709	WCAP-C-SGP	0805		X7R	X7R0805...	2,20 µF	25,0 V	> 50,0 MΩ	-23,5 %

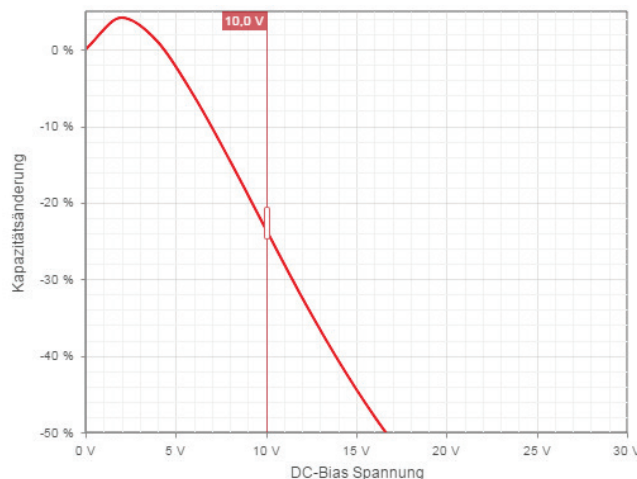

Figure 22: graph in REDEXPERT showing DC bias behavior.

# Application Note

## LC Filter Design With MLCCs: Why The Applied Voltage Matters

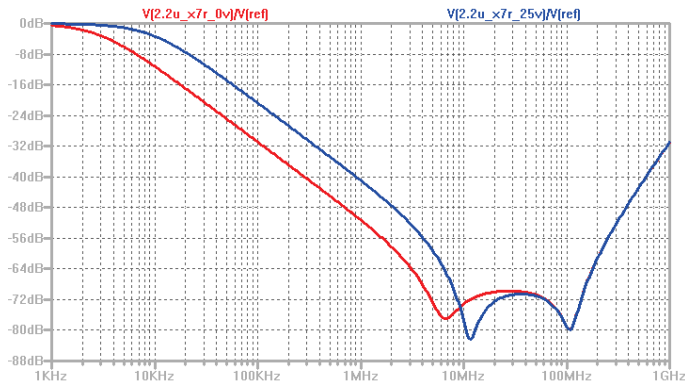

Figure 24: simulation of an LC filter relative to a 50Ω reference.

### 5 Summary

The demand for ever more compact electronic devices means that the electrical characteristics of the filter components – specifically the MLCC, in this case – must be considered as well. In particular, attention must be given to the relationship of capacitance and applied voltage. The data can all be found in the **REDEXPERT** online-platform or obtained on request. If these data are taken into account,

the filter's characteristics can be very accurately estimated. Dependencies have been demonstrated and examined using two different filter boards. Real filters can also be simulated if these effects are taken into consideration.

Another factor affecting filter properties is the general temperature of the application. For example, the capacitance of an X7R ceramic varies by +/-15% within its specified temperature range of -55°C to 125°C. Long-term operation causes a certain ageing of the material (a process of structural bias; this is reversible by heating), which also reduces the capacitance. Again, it is a good idea to regard the filter and its tolerances as non-ideal, and make 'worst-case' estimations. LTSpice offers various ways of doing this, including the Monte Carlo method.

If larger capacitors are an option, aluminum electrolytic capacitors can also be used. Care must be taken over the permissible ripple current when selecting aluminum electrolytic capacitors. Service life can also be estimated in advance. Aluminum polymer electrolytic capacitors offer an alternative if greater longevity, low ESR values or high capacitance values are required. Similarly, aluminum and aluminum polymer electrolytic capacitors exhibit no DC bias characteristics – unlike ceramic capacitors.

# Application Note

## LC Filter Design With MLCCs: Why The Applied Voltage Matters



### A. Appendix

#### A.1. Bill of Material

##### Filter Board 1

Index	Description	Size	Value	Article number
<b>C<sub>1</sub></b>	Ceramic capacitor	0805	10 nF, 10 V, NPO	<a href="#">885 012 007 009</a>
<b>C<sub>2</sub></b>	Ceramic capacitor	0805	2,2 µF, 6,3 V, X5R	<a href="#">885 012 107 001</a>
<b>C<sub>3</sub></b>	Ceramic capacitor	0805	2,2 µF, 6,3 V, X7R	<a href="#">885 012 207 001</a>
<b>C<sub>4</sub></b>	Ceramic capacitor	0805	2,2 µF, 25 V, X5R	<a href="#">885 012 207 079</a>
<b>C<sub>5</sub> / C<sub>6</sub></b>	Ceramic capacitor	0805	1 µF, 10 V, X7R	<a href="#">885 012 207 022</a>
<b>L<sub>1</sub> to L<sub>5</sub></b>	SMD-Ferrite	0805	Z @ 100 MHz = 2200 Ω	<a href="#">742 792 093</a>

##### Filter Board 2

Index	Description	Size	Value	Article number
<b>C<sub>1</sub></b>	Ceramic capacitor	0805	47 µF, 6,3 V, X5R	<a href="#">885 012 107 006</a>
<b>C<sub>2</sub></b>	Ceramic capacitor	0805	22 µF, 6,3 V, X5R	<a href="#">885 012 107 005</a>
<b>C<sub>3</sub></b>	Ceramic capacitor	0805	10 µF, 6,3 V, X5R	<a href="#">885 012 107 004</a>
<b>C<sub>4</sub></b>	Ceramic capacitor	0805	4,7 µF, 6,3 V, X5R	<a href="#">885 012 107 003</a>
<b>C<sub>5</sub></b>	Ceramic capacitor	0805	3,3 µF, 6,3 V, X5R	<a href="#">885 012 107 002</a>
<b>L<sub>1</sub> to L<sub>5</sub></b>	SMD-Ferrite	0805	Z @ 100 MHz = 2200 Ω	<a href="#">742 792 093</a>

#### A.2. References

- [1] [ANP044](#) by ANDREAS NADLER, Impact of the layout, components, and filters on the EMC of modern DC/DC switching controllers
- [2] Frank Puhane, Filter Design with Chip Beads, 21.05.2014, Würth Elektronik eiSos GmbH & Co. KG

# Application Note

## LC Filter Design With MLCCs: Why The Applied Voltage Matters



### IMPORTANT NOTICE

The Application Note is based on our knowledge and experience of typical requirements concerning these areas. It serves as general guidance and should not be construed as a commitment for the suitability for customer applications by Würth Elektronik eiSos GmbH & Co. KG. The information in the Application Note is subject to change without notice. This document and parts thereof must not be reproduced or copied without written permission, and contents thereof must not be imparted to a third party nor be used for any unauthorized purpose.

Würth Elektronik eiSos GmbH & Co. KG and its subsidiaries and affiliates (WE) are not liable for application assistance of any kind. Customers may use WE's assistance and product recommendations for their applications and design. The responsibility for the applicability and use of WE Products in a particular customer design is always solely within the authority of the customer. Due to this fact it is up to the customer to evaluate and investigate, where appropriate, and decide whether the device with the specific product characteristics described in the product specification is valid and suitable for the respective customer application or not.

The technical specifications are stated in the current data sheet of the products. Therefore the customers shall use the data sheets and are cautioned to verify that data sheets are current. The current data sheets can be downloaded at [www.we-online.com](http://www.we-online.com). Customers shall strictly observe any product-specific notes, cautions and warnings. WE reserves the right to make corrections, modifications, enhancements, improvements, and other changes to its products and services.

WE DOES NOT WARRANT OR REPRESENT THAT ANY LICENSE, EITHER EXPRESS OR IMPLIED, IS GRANTED UNDER ANY PATENT

RIGHT, COPYRIGHT, MASK WORK RIGHT, OR OTHER INTELLECTUAL PROPERTY RIGHT RELATING TO ANY COMBINATION, MACHINE, OR PROCESS IN WHICH WE PRODUCTS OR SERVICES ARE USED. INFORMATION PUBLISHED BY WE REGARDING THIRD-PARTY PRODUCTS OR SERVICES DOES NOT CONSTITUTE A LICENSE FROM WE TO USE SUCH PRODUCTS OR SERVICES OR A WARRANTY OR ENDORSEMENT THEREOF.

WE products are not authorized for use in safety-critical applications, or where a failure of the product is reasonably expected to cause severe personal injury or death. Moreover, WE products are neither designed nor intended for use in areas such as military, aerospace, aviation, nuclear control, submarine, transportation (automotive control, train control, ship control), transportation signal, disaster prevention, medical, public information network etc. Customers shall inform WE about the intent of such usage before design-in stage. In certain customer applications requiring a very high level of safety and in which the malfunction or failure of an electronic component could endanger human life or health, customers must ensure that they have all necessary expertise in the safety and regulatory ramifications of their applications. Customers acknowledge and agree that they are solely responsible for all legal, regulatory and safety-related requirements concerning their products and any use of WE products in such safety-critical applications, notwithstanding any applications-related information or support that may be provided by WE.

CUSTOMERS SHALL INDEMNIFY WE AGAINST ANY DAMAGES ARISING OUT OF THE USE OF WE PRODUCTS IN SUCH SAFETY-CRITICAL APPLICATIONS.

### USEFUL LINKS



Application Notes

[www.we-online.com/app-notes](http://www.we-online.com/app-notes)



**REDEXPERT** Design Tool

[www.we-online.com/redexpert](http://www.we-online.com/redexpert)



Toolbox

[www.we-online.com/toolbox](http://www.we-online.com/toolbox)



Produkt Katalog

[www.we-online.com/products](http://www.we-online.com/products)

### CONTACT INFORMATION

[appnotes@we-online.com](mailto:appnotes@we-online.com)

Tel. +49 7942 945 - 0



Würth Elektronik eiSos GmbH & Co. KG  
Max-Eyth-Str. 1 · 74638 Waldenburg · Germany

[www.we-online.com](http://www.we-online.com)

